

Navigation Tools: Click on the “Table of Contents” below, or use the Bookmarks to the left.

## Contents

How to Use This Manual [1](#)  
Circuit Schematics (see Circuit Index)  
Fuse/Relay Boxes 6  
Ground-to-Components Index 6-8  
Connector Index 200  
Component Location 201  
Connector Terminal Views 202  
Connector-to-Harness Locations 203  
Terminal Replacement Procedures 204

## Circuit Index

A/C condenser fan 63  
Accessory power socket  
  USA: Base; Canada 155  
  USA: CR, CR Audio – A/C 155-1  
Air conditioner — see HVAC  
Audio system  
  USA: Base, CR Audio – A/C; Canada 150  
  Honda Accessory  
  CD changer 150-3  
  XM radio  
  USA: Base, CR Audio – A/C 150-4  
Back-up lights 110-9  
Brake lights 110-11  
Ceiling lights 114  
Charging system 22  
Console lights 114-1  
Convertible top  
  USA: Base; Canada 121  
Cruise control 34  
Dash lights 114-1  
Door indicator 80-4  
DRL — see Exterior lights  
Engine coolant temperature gauge 80  
EPS 45  
Exterior lights  
  Back-up lights 110-9  
  Brake lights 110-11  
  DRL (Daytime running lights)  
    Canada 110-4  
    USA 110  
  Hazard warning lights 110-8  
  Headlights  
    Canada 110-4  
    USA 110  
  License plate lights 110-10  
  Parking lights 110-10  
  Side marker lights 110-10  
  Taillights 110-10  
  Turn signal lights 110-8  
Fans 63  
Fuel and emissions  
  DLC and MIL circuits 23-1  
  ECM power and ground 23  
  ETCS (Electronic throttle control system) 23-6  
  EVAP system 23-10  
  Fuel supply system 23-9  
  Idle control system 23-8  
  PGM-FI system 23-2  
Fuel gauge 80  
Fuse box  
  Auxiliary under-hood 6-6  
Fuse/relay box  
  Main under-hood 6  
  Under-dash 6-2  
Gauges 80  
Ground distribution 14  
Ground-to-components index 6-8  
Hazard warning lights 110-8  
Headlights  
  Canada 110-4  
  USA 110  
Heater — see HVAC  
Horns 40  
HVAC 60  
Ignition system 20  
Immobilizer system 132  
Indicators 80  
Interior lights  
  Ceiling light 114  
  Console lights 114-1  
  Dash lights 114-1  
  Spotlights 114  
  Trunk light 114  
Key-in reminder 73  
Keyless entry 130  
License plate lights 110-10  
Lights-on reminder 73  
Low fuel indicator 80-2  
Low oil pressure indicator 80-6  
Odometer 80  
Parking lights 110-10  
PGM-FI — see Fuel and emissions  
Power distribution 10  
Power door locks 130  
Power mirrors 141  
Power windows 120  
Radiator fan 63  
Rear window defogger 64  
Seat belt reminder 73  
Security system  
  Honda Accessory 133  
Side marker lights 110-10  
Speedometer 80  
Splice and junction connector details 15  
Spotlights 114  
SRS 47  
Starting system 21  
Tachometer 80  
Taillights 110-10  
TPMS (Tire pressure monitoring system) 85  
Trunk indicator 80-6  
Trunk lid opener 134  
Trunk light 114  
Turn signal lights 110-8  
VSA 36  
VTEC system 31  
Wiper/washer 91



## How To Use This Manual



The next few pages describe how this manual is organized. They also explain what kind of information the manual contains, what the information means, and how to use it to troubleshoot electrical problems.

Circuit schematics break the entire electrical system into individual systems, like the Back-up Lights on the next page. Only electrical components that work together are shown together, so you will not be distracted by unrelated wires.

Explanations of the abbreviations and symbols used in the schematics begin on page [7](#). You will need to know what they mean before you can use a schematic effectively.







## Power Distribution Schematics

Power Distribution schematics show how power is supplied from the positive battery terminal to various circuits in the vehicle. Refer to the Power Distribution section to get a more detailed understanding of how power is supplied to the circuit you are working on. Individual circuit schematics begin with a fuse. So, if Power Distribution shows that an inoperative circuit and another circuit share a fuse, check a component in the other circuit. If it works, you know the fuse is good, and power is available to the inoperative circuit.

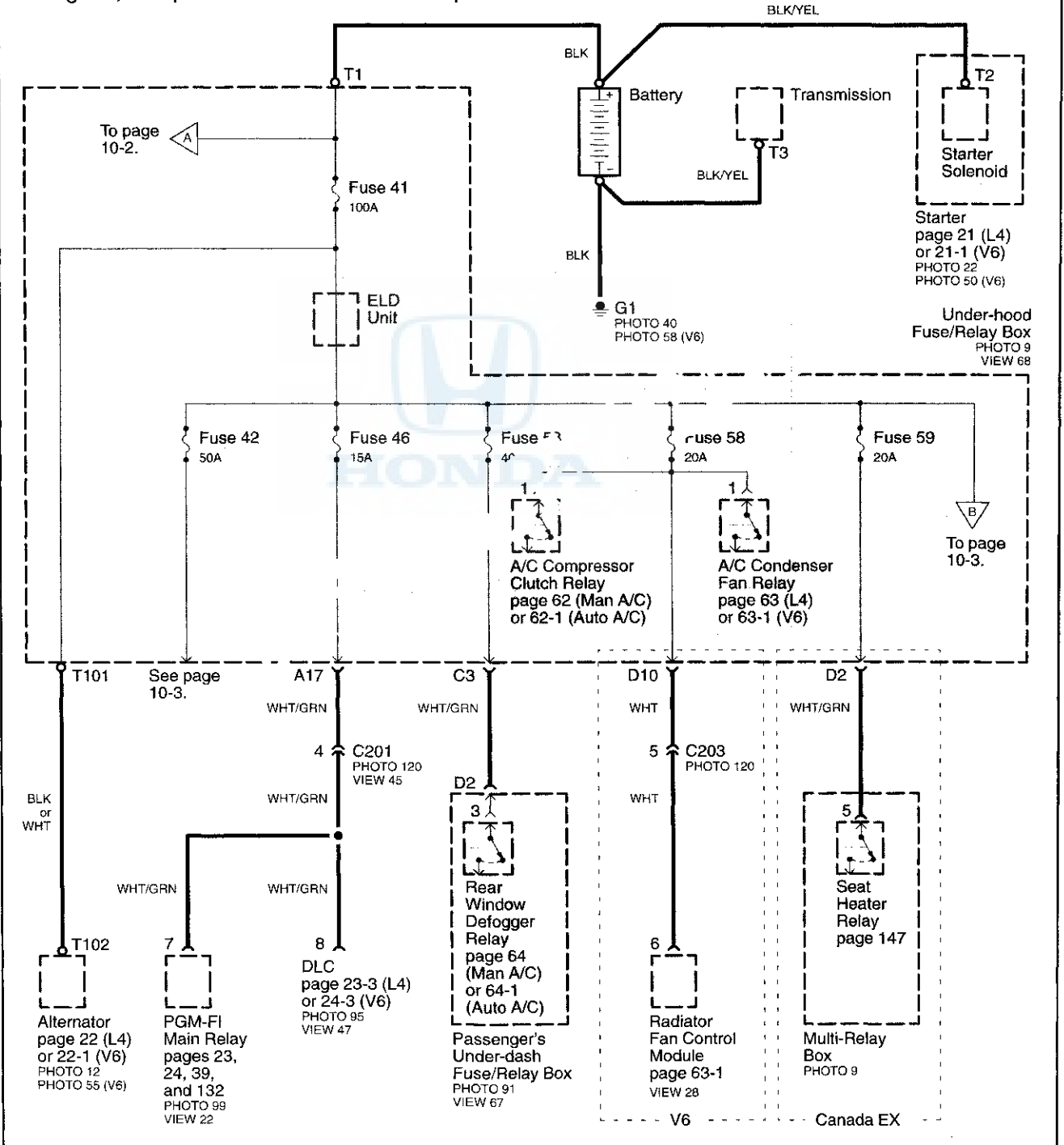

# How To Use This Manual

## Ground Distribution Schematics

This sample Ground Distribution schematic shows all of the components that share the same ground point.

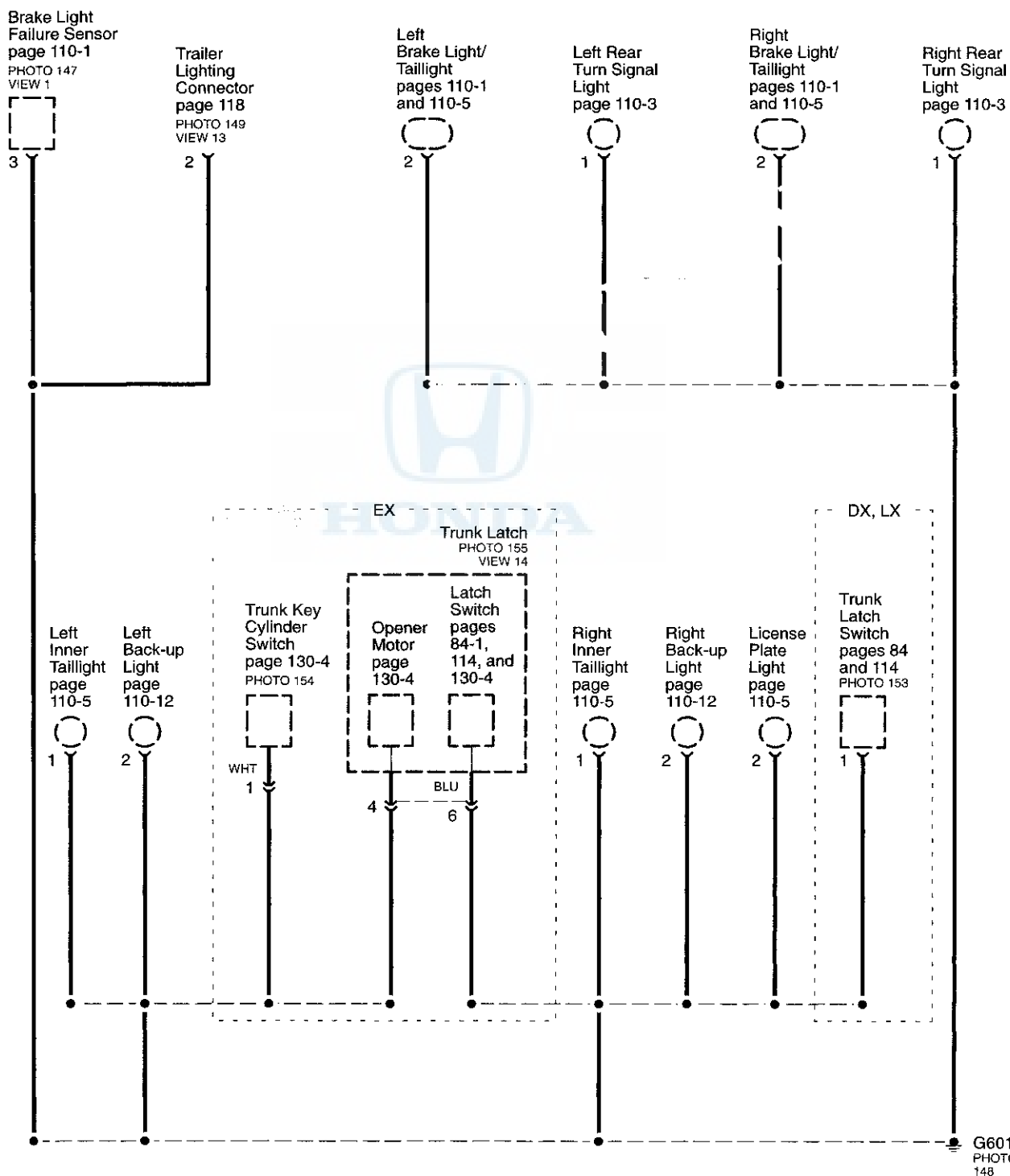



## Connector Locations

To see where a component or connector is located on the vehicle, look up its photo number in the Component Location section that begins on page 201. The photo will also tell you the color of the connector and how many cavities it has.

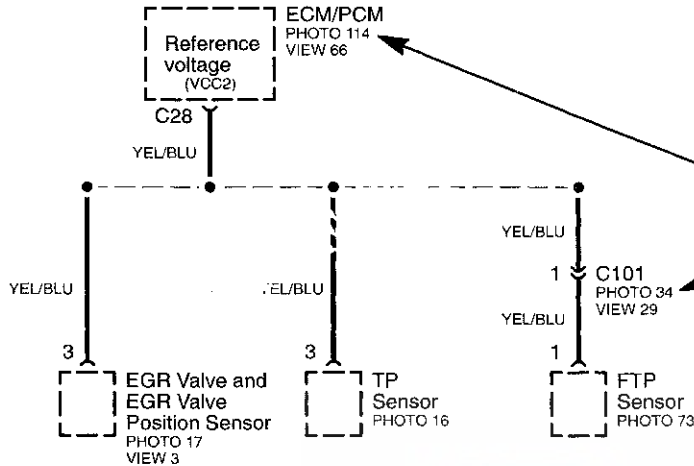

To see where connectors and parts are located, look up their photos in the Component Location section that begins on page 201.

If there is no photo number below or beside a component name or a connector, ground, or terminal number, look up that name or number in the appropriate Connector-to-Harness Index that begins on page 203. The chart lists how many cavities a connector has, where it is located, and what it connects to. The related illustration shows the connector's location on the harness, and the harness routing.

### Driver's Power Seat Wire Harness

Ref	Connector or Terminal	Cavities/Color	Location	Connects to	Notes
1	Power seat rear up-down motor	2-GRY	Under driver's seat		EX
2	Power seat front up-down motor	2-GRY	Under driver's seat		EX
3	Driver's seat belt switch	2-GRY	Under driver's seat		EX
4	Not used	3	Under driver's seat		Heated seats EX
5	Power seat adjustment switch connector B	6-GRY	Left side of driver's seat		EX
6	C552	10-GRY	Under driver's seat	Left side wire harness (see page 203-20)	
7	Power seat adjustment switch connector A	6-GRY	Left side of driver's seat		EX
8	Power seat recline motor	2-GRY	Under driver's seat		EX
9	Power seat slide motor	2-GRY	Under driver's seat		EX

**DRIVER'S POWER SEAT WIRE HARNESS**

**203-31**

# How To Use This Manual

## Connector Terminal Views

To see the configuration of a connector's cavities, look up its view number in the Connector View section that begins on page 202. Each view includes the color of the connector, where it is located, and what it connects to.

Use the Connector View Section to help locate the proper cavity when you need to test a connector. It can be especially helpful if the connector has more than one wire of the same color. A dash symbol (—) indicates that the cavity is empty.

Connector views can also be used to help diagnose multiple symptoms in separate circuits that could be caused by a single problem in a connector shared by those circuits. Here is how:

- 1 Pick one of the multiple symptoms and look up the schematic for that circuit.
- 2 Make a list of all the in-line and fuse box connectors in that schematic (include page numbers).
- 3 Then, in the Connector View section, look up each connector on your list to see if circuits related to the other symptoms run through one of them. If they do, inspect that connector for the problem.

Example: The blower, rear window defogger, and the windshield wiper do not work. List all in-line and fuse box connectors in the blower controls circuit and then check the Connector View section (sample below). You find that C324 is common to the rear window defogger circuit and wiper/washer circuit, so you inspect C324 and find the problem: damaged terminals.

## Connector Terminal Views

### 21. C324

- Brown
- Behind left kick panel
- Connects left engine compartment wire harness to main wire harness



- |                                     |                          |
|-------------------------------------|--------------------------|
| 1 WHT (Blower controls)             | 4 BLU/YEL (Wiper/washer) |
| 2 YEL/BLU<br>(Rear window defogger) | 5 BLU (Wiper/washer)     |
| 3 BLK/WHT (Starting)                | 6 BLK/YEL (Ignition)     |
|                                     | 7 WHT/BLU (ABS)          |



## Symbols

### Wire Color Abbreviations

The following abbreviations are used to identify wire colors in the circuit schematics:

BLK	.....	black
BLU	.....	blue
BRN	.....	brown
GRN	.....	green
GRY	.....	gray
LT BLU	.....	light blue
LT GRN	.....	light green
ORN	.....	orange
PNK	.....	pink
PUR	.....	purple
RED	.....	red
WHT	.....	white
YEL	.....	yellow
NAT	.....	natural

### Wires

Wire insulation can be one color, or one color with another color stripe. (The second color is the color of the stripe.)

This circuit continues on another page or at a different location on the same page. The arrow shows direction of current flow. To follow the RED/BLK wire in these examples, you would look for the "A" arrow on page 23-5 or on the same page.

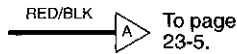

This means that the branch of the wire connects to another circuit. The arrow points to the name of the circuit branch where the wire continues.

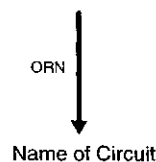

A broken line means that this part of the circuit is not shown. Refer to the page listed for the complete schematic.

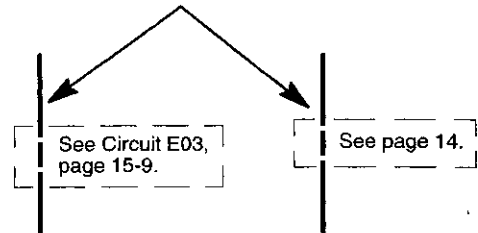

Where separate wires join, only the splice is shown. For details on the additional wiring, refer to the page listed.

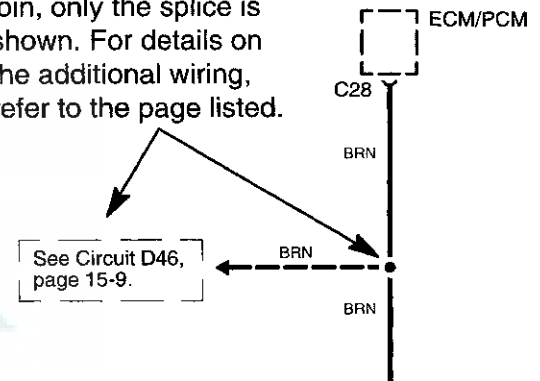

Wire choices for options or different models are labeled and are shown with a "choice" bracket like this.

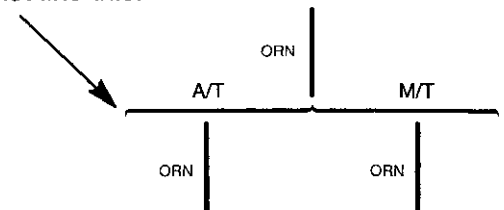

This broken line means that both terminals are in connector C134.

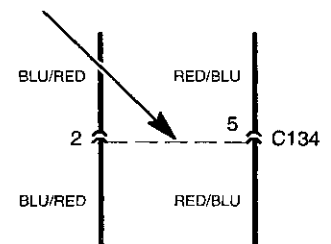

# How To Use This Manual

## Symbols

### Connectors – “C”

The cavities and wire terminals in each connector are numbered starting from the upper left (locking tab up), looking at the male terminals from the terminal side or looking at the female terminals from the wire side. Both views are in the same direction so the numbers are the same. The gender of the connector is determined by the pins within the connector. All cavities are numbered, even if they have no wire terminals in them.

NOTE: DLC terminals are numbered according to SAE standard J1962, not the Honda standard. The numbers of the four end terminals are molded into the corners of the connector face.

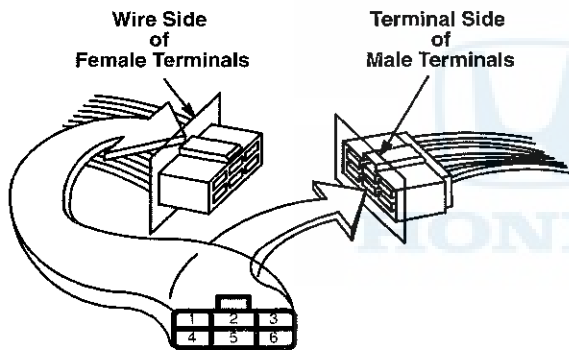

The connector cavity number is listed next to each terminal on the circuit schematic. The cavity/terminal shown below is #6.

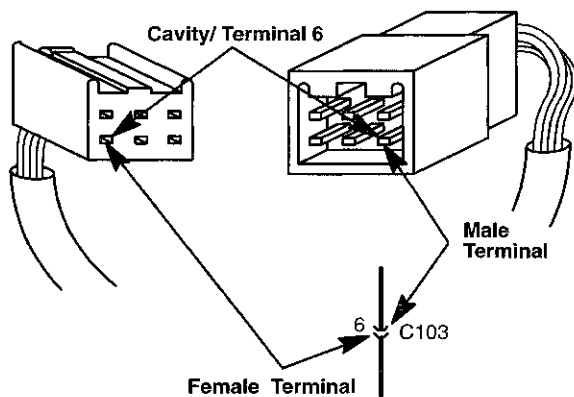

This means that the connector connects directly to the component.

This means that the connector connects to a lead (pigtail) wired directly to the component.

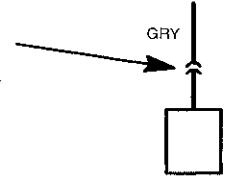

This symbol represents one bus bar inside the cap of a junction connector.

A junction connector cap may contain several bus bars, but only the one affecting that circuit will be shown.

The dots represent tabs on the bar that the wire terminals connect to.

Remaining wires to the same bus bar are represented by a dashed line.

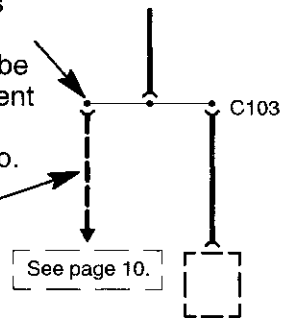

See page 10.

### Splices

Splices are shown as a dot. Their location and the number of wires may vary depending on the harness manufacturer.

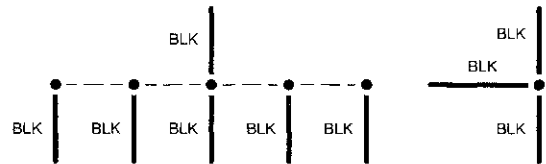

### Components

A solid border line means that the entire component is shown.



A broken border line indicates that only part of the component is shown.



The name of the component appears next to it, followed by notes about its function and any photo and connector view references.



Brake Pedal Position Switch  
1 = Brake pedal pressed.  
PHOTO 98



## Symbols

### Ground – “G”

This symbol means that the end of the wire is attached (grounded) to the car frame or to a metal part connected to the frame.



Each wire ground (G) is numbered for reference.

This ground symbol (dot and 3 lines) overlapping the component means that the housing of the component is grounded to the vehicle frame or to a metal part connected to the frame.



This symbol represents the bus bar inside a ground connector. The dots represent tabs on the bus bar that the wire terminals connect to.



The ground symbol (large dot) is the connection between the bus bar and metal (grounded) part of the vehicle.

### Terminals – “T”

Each “T” terminal (ring type) is numbered for reference and location. A “T” terminal is secured with a screw or bolt.

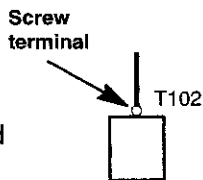

### Shielding

This represents RFI (Radio Frequency Interference) shielding around a wire.

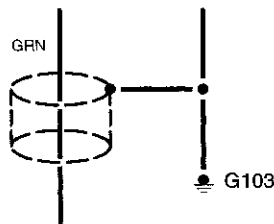

### Switches

These switches move together; the broken straight line between them means that they are mechanically connected.



Other types of switches are controlled by a coil or a solid state circuit. Unless otherwise noted, all switches are shown in their normal (rest) position, with power off.



### Fuses

This means that power is supplied when the ignition switch is in ON (II).

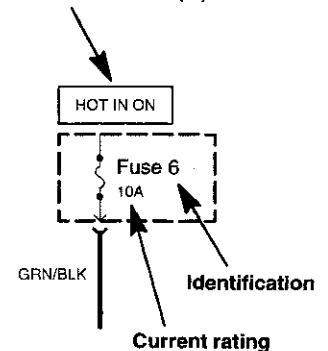

### Diodes

A rectifier diode works like a one way valve. It allows current to flow only in the direction of the arrow.



A Zener diode blocks reverse current at normal voltages just like a rectifier diode. At high voltages, however, a Zener diode allows current to flow in reverse.



# How To Use This Manual

## Symbols

### Light Emitting Diode (LED)

LEDs are special diodes that emit light when connected in a circuit. LEDs work the same as a rectifier diode by allowing current to flow only in one direction.



### Motor

This symbol represents a DC voltage electrical motor. Motors can reverse direction by changing the polarity of the voltage.



### Pressure Sensor

A pressure sensor is a variable resistor used to monitor the difference in pressure between the intake manifold and outside atmosphere (Map Sensor). This information is used by the engine computer to monitor engine load (vacuum drops when the engine is under load or at wide open throttle). When the engine is under load, the computer alters spark timing and fuel mixture to control performance and emissions.

NOTE: There is also a FTP (Fuel Tank Pressure) Sensor used to monitor EVAP System testing.

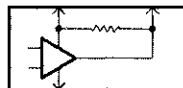

### Resistor

This symbol represents a component in electrical circuits that resists the flow of electrical current. Resistance is measured in Ohms. Higher resistance results in less current flow. This type of resistor has a fixed resistance value.



### Variable Resistor

This symbol represents a component in electrical circuits that resists the flow of electrical current. Resistance is measured in Ohms. Higher resistance results in less current flow. This type of resistor (thermistor) has a variable resistance value that changes with temperature. The resistance of a thermistor decreases as temperature increases.



### Solenoid

An electromagnet is produced by current flowing through a coil of wire. A plunger inside the wire coil is moved by the electromagnet turning ON or OFF.



### Transistors

Transistors are electrical devices that have two key properties: 1) they can amplify an electrical signal and 2) they can switch ON and OFF, letting current through or blocking it as necessary.

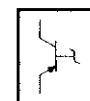





## Five-Step Troubleshooting

### 1. Verify The Complaint

Turn on all the components in the problem circuit to check the accuracy of the customer complaint. Note the symptoms. Do not begin disassembly or testing until you have narrowed down the problem area.

### 2. Analyze The Schematic

Look up the schematic for the problem circuit. Determine how the circuit should work by tracing the current paths from the power source through the circuit components to ground (certain circuits contain a "How the Circuit Works" section). Also, trace circuits that share wiring with the problem circuit. The names of circuits that share the same fuse, ground, or switch, and so on, are referred to in each circuit schematic. Try to operate any shared circuits you did not check in step 1. If the shared circuits work, the shared wiring is OK, and the cause must be in the wiring used only by the problem circuit. If several circuits fail at the same time, the fuse or ground is a likely cause.

Based on the symptoms and your understanding of the circuit's operation, identify one or more possible causes.

### 3. Isolate The Problem By Testing The Circuit

Make circuit tests to check the diagnosis you made in step 2. Keep in mind that a logical, simple procedure is the key to efficient troubleshooting. Test for the most likely cause of failure first. Try to make tests at points that are easily accessible.

### 4. Fix The Problem

Once the specific problem is identified, make the repair. Be sure to use proper tools and safe procedures.

### 5. Make Sure The Circuit Works

Turn on all components in the repaired circuit in all modes to make sure you have fixed the entire problem. If the problem was a blown fuse, be sure to test all of the circuits on that fuse. Make sure that no new problems turn up and that the original problem does not recur.

## Test Equipment

### CAUTION:

**Most circuits include solid-state devices. Test the voltages in these circuits only with a 10-megaohm or higher impedance digital multimeter. Never use a test light or analog meter on circuits that contain solid-state devices. Damage to the devices may result.**

### Test Light and DVOM

On circuits without solid-state devices, use a test light to check for voltage. A test light is made up of a 12 volt bulb with a pair of leads attached. After grounding one lead, touch the other lead to various points along the circuit where voltage should be present. The bulb will light if there is voltage at the point being tested. If you need to know how much voltage is present, use a digital volt/ohmmeter (DVOM). If, in addition, you need to know exactly how much resistance there is between two points, use a digital volt/ohmmeter (DVOM).

In the "OHMS" range, the DVOM will measure resistance between two points along a circuit. Low resistance means good continuity.

Diodes and solid-state devices in a circuit can make a DVOM give a false reading. To check a reading, reverse the leads, and take a second reading. If the readings differ, the component is affecting the measurement.

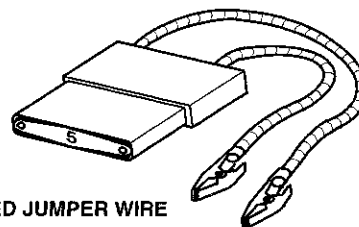

FUSED JUMPER WIRE

To order any test equipment shown above, contact your local tool supplier. For a list of suppliers and tool numbers, refer to Honda Required Special Tools and Equipment Service Bulletin.

# How To Use This Manual

## - Test Equipment

### Jumper Wire

Use a jumper wire to bypass an open circuit. A jumper wire is made up of an in-line fuse holder connected to a set of test leads. It should have a five ampere fuse. Never connect a jumper wire across a short circuit. The direct battery short will blow the fuse.

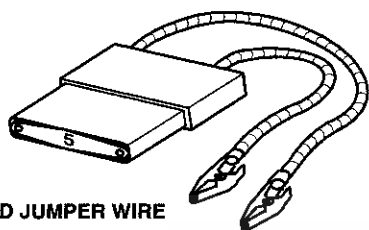

FUSED JUMPER WIRE

To order any test equipment shown above, contact your local tool supplier. For a list of suppliers and tool numbers, refer to Honda Required Special Tools and Equipment Service Bulletin.

## Troubleshooting Precautions

### Before Troubleshooting

1. Check the main fuse and the fuse box.
2. Check the battery for damage, state of charge, and clean and tight connections.

#### CAUTION:

- Do not quick-charge a battery unless the battery ground cable has been disconnected, or you will damage the alternator diodes.
- Do not attempt to crank the engine with the ground cable disconnected or you will severely damage the wiring.

### While You're Working

1. Make sure that connectors are clean and have no loose terminals or receptacles.
2. Make sure that connectors without wire seals are packed with dielectric (silicone) grease. Part Number: 08798-9001.

Pack with dielectric (silicone) grease

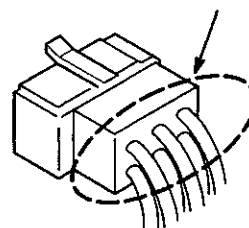

3. When connecting a connector, push it until it "clicks" into place.

#### CAUTION:

- Do not pull on the wires when disconnecting a connector. Pull only on the connector housings.
- Most circuits include solid-state devices. Test the voltages in these circuits only with a 10-megaohm or higher impedance digital multimeter. Never use a test light or analog meter on circuits that contain solid-state devices. Damage to the devices may result.



## Troubleshooting Tests

### Testing for Voltage

When testing for voltage at a connector without wire seals, you do not have to separate the two halves of the connector. Instead, probe the connector from the back. Always check both sides of the connector because dirty, corroded, and bent terminals can cause problems (no electrical contact = an open).

1. Connect one lead of the test light to a known good ground, or if you are using a digital volt ohmmeter (DVOM), place it in the appropriate DC volts range, and connect its negative lead to ground.

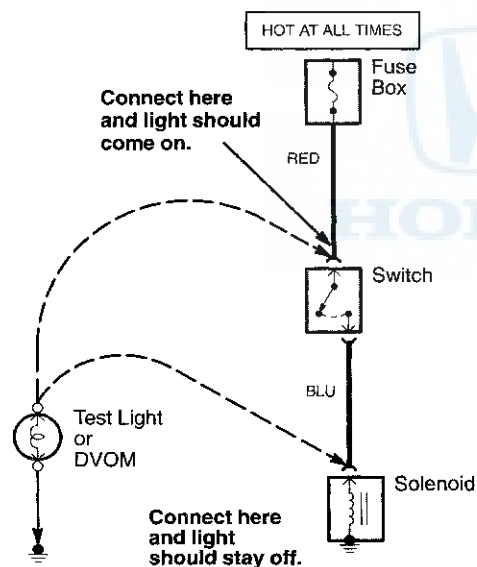

2. Connect the other lead of the test light or DVOM to the point you want to check.
3. If the test light glows, there is voltage present. If you are using a DVOM, note the voltage reading. It should be within one volt of measured battery voltage. A loss of more than one volt indicates a problem.

**NOTE:** Always use a DVOM on high impedance circuits. A test light may not glow (even with battery voltage present).

### Testing for Continuity

When testing for continuity at a connector without wire seals, you do not have to separate the two halves of the connector. Instead, probe the connector from the back. Always check both sides of the connector because dirty, corroded, and bent terminals can cause problems (no electrical contact = an open).

1. Disconnect the negative cable from the vehicle battery. If you are using a DVOM, place it in the lowest "OHMS" range.
2. Connect one lead of a DVOM to one end of the part of the circuit you want to test.

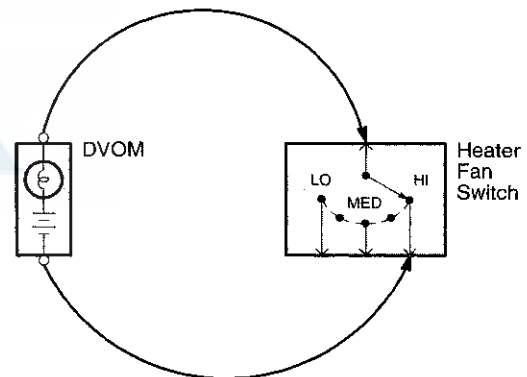

3. Connect the other lead to the other end.
4. If you are using a DVOM, a low reading or no reading (zero), means good continuity.

# How To Use This Manual

## - Troubleshooting Tests

### Testing for Voltage Drop

Wires, connectors, and switches are designed to conduct current with a minimum loss of voltage. A voltage drop of more than one volt indicates a problem. Circuits must be operating when checking voltage drop.

1. Place the digital volt/ohmmeter (DVOM) in the appropriate DC volts range. Connect the positive lead to the end of the wire (or to the connector or switch) closest to the battery.

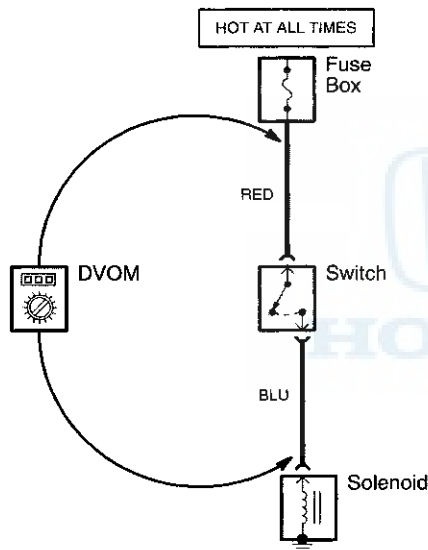

2. Connect the negative lead to the other end of the wire (or the other side of the connector or switch).
3. Turn on the components in the circuit.
4. The DVOM will show the difference in voltage between the two points. A difference, or drop, of more than one volt indicates a problem. Check the circuit for loose, dirty, or bent terminals.

### Testing for a Short with a Test Light or DVOM

1. Remove the blown fuse and disconnect the load.
2. Connect a test light or digital volt/ohmmeter (DVOM), switched to the appropriate DC volts range, across the fuse terminals to make sure voltage is present. You might have to turn the ignition switch to ON; check the schematic to see.

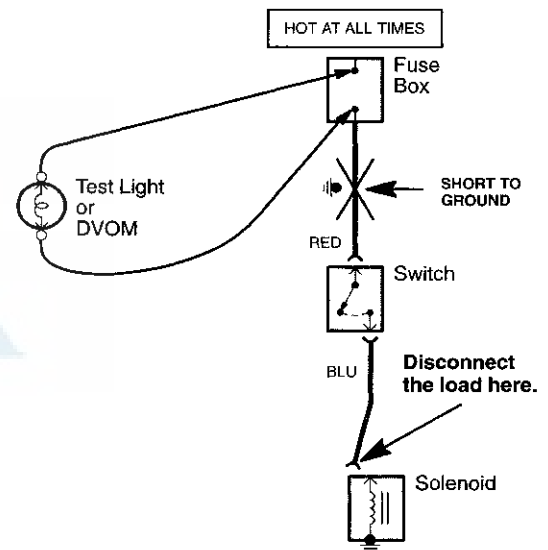

3. Beginning near the fuse box, wiggle the harness. Continue this at convenient points about six inches apart while watching the test light or DVOM.
4. Where the test light goes off, or the DVOM voltage drops to zero, there is a short to ground in the wiring near that point.

**NOTE:** Always use a DVOM on high impedance circuits. A test light may not glow (even with battery voltage present).



# Fuse/Relay Boxes

## - Main Under-hood Fuse/Relay Box

### Fuse-to-Components Index

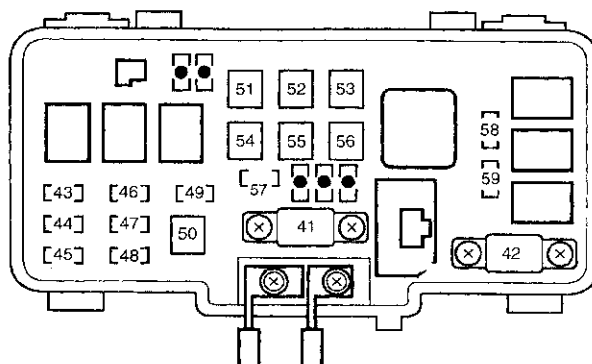

Fuse Number	Fuse Name	Amps	Page	Component or Circuit Protected
41	BATTERY	100	10	Battery, ELD unit, Power distribution
42	IGI MAIN	40	10-3	IG2 relay, Ignition switch (BAT)
43	R HEADLIGHT	20	10-10	DRL control unit, Right headlight (low beam)
44	—	—	—	Not used
45	L HEADLIGHT	20	10-10	DRL control unit, DRL diode 1, Gauge assembly, High beam cut relay, Left headlight (low beam)
46	ACG S	15	10-11	DLC, ECM, Ignition coil relay, PGM-FI main relay 1, PGM-FI main relay 2
47	STOP	15	10-2	Brake pedal position switch, Horn relay
48	VSA F/S	30	10-2	VSA modulator-control unit
49	HAZARD	10	10-2	Hazard warning switch
50	VSA MOTOR	30	10-2	VSA modulator-control unit
51	P/W MOTOR	40	10-1	No. 17 and 18 fuses (in the under-dash fuse/relay box)
52	SOFT TOP MOTOR R	20	10	Convertible top control unit (USA: Base; Canada)
53	ACC SOCKET	20	10	Accessory power socket relay (USA: CR, CR Audio – A/C)
54	BACK-UP, ACC	30	10-1	Headlight relay 1, No. 22, 23, 24, 25, 26 and 27 fuses (in the under-dash fuse/relay box)
55	SOFT TOP MOTOR L	20	10	Convertible top control unit (USA: Base; Canada)
56	HEATER MOTOR	40	10-1	Blower motor relay
57	COOLING FAN	30	10-1	Radiator fan relay
58	CONDENSER FAN	20	10-1	A/C condenser fan relay A/C compressor clutch relay
59	DBW	20A	10-1	Headlight relay 2, No. 14, 15, 16 and 21 fuses (in the under-dash fuse/relay box)



## Connector-to-Fuse/Relay Box Index

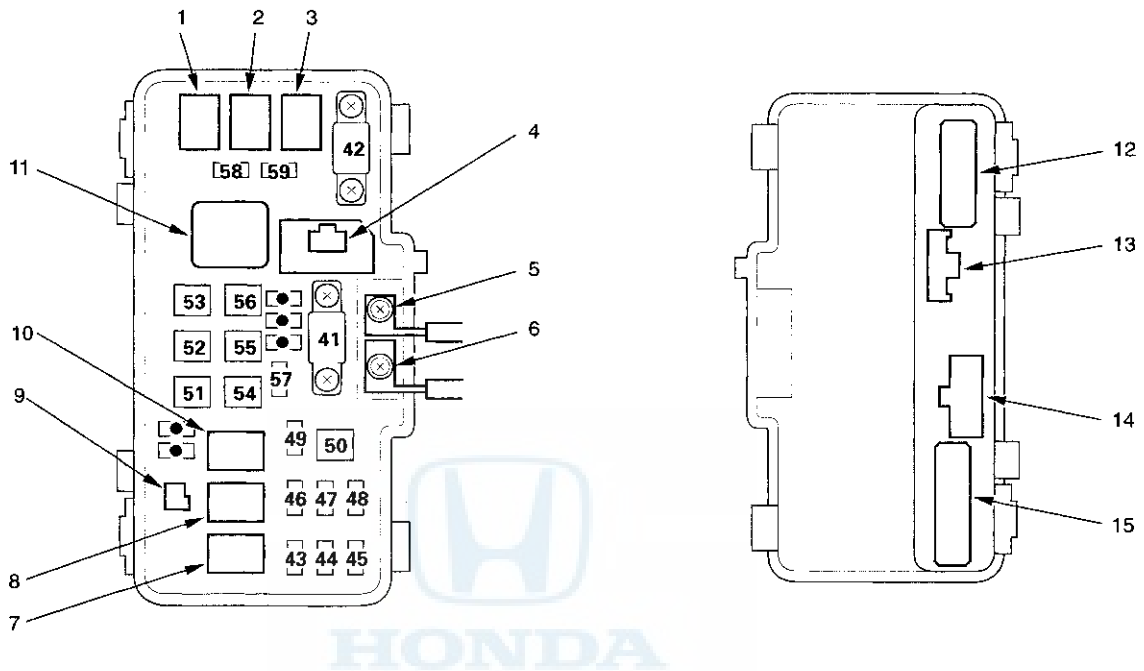

Ref	Socket	Cavities	Connects to
1	A/C condenser fan relay	4	
2	Radiator fan relay	4	
3	A/C compressor clutch relay	4	
4	ELD Unit	3	Right engine compartment wire harness (see page 203-4)
5	T101		Engine wire harness (see page 203-2)
6	T1		EPS sub-harness (see page 203)
7	Headlight relay 1	4	
8	Headlight relay 2	4	
9	Diode	2	
10	Horn relay	4	
11	Blower motor relay	4	
12	Connector D	16	Right engine compartment wire harness (see page 203-4)
13	Connector C	3	Right engine compartment wire harness (see page 203-4)
14	Connector B	7	Right engine compartment wire harness (see page 203-4)
15	Connector A	18	Right engine compartment wire harness (see page 203-4)

# Fuse/Relay Boxes

## - Under-dash Fuse/Relay Box

### Fuse-to-Components Index

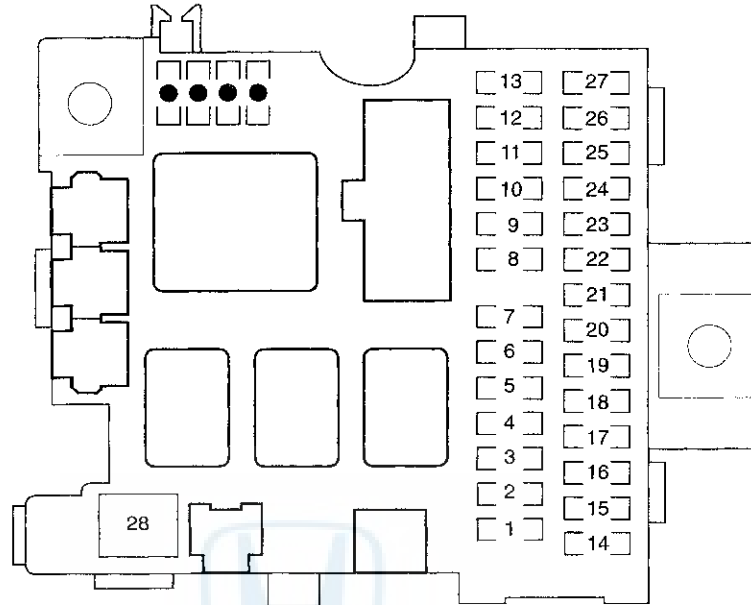

Fuse Number	Fuse Name	Amps	Page	Component or Circuit Protected
1	SRS	10	10-11	SRS unit (VA)
2	FUEL PUMP SRS	15	10-11	SRS unit (VB) ECM, Fuel tank unit, Immobilizer control unit-receiver, Imoes unit, Passenger's airbag cut-off indicator, Passenger's weight sensor unit, PGM-FI main relay 2
3	ENGINE START	7.5	10-4	Clutch interlock switch, Engine start switch, Starter cut relay, Starter solenoid
4	—	—	—	Not used
5	METER BACK-UP LIGHT	7.5	10-5	Back-up light switch, Convertible top control unit (USA: Base; Canada), EPS control unit, Gauge assembly, Keyless door lock control unit, TPMS control unit
6	ACG	15	10-6	Alternator, Cruise control main switch, ELD unit, EVAP canister purge valve, Rear window defogger change relay, Secondary HO2S, Steering angle sensor, VSA modulator-control unit
7	TURN LIGHT	7.5	10-5	Hazard warning switch
8	FRONT WIPER	20	10-9	Convertible top switch (USA: Base; Canada), Intermittent wiper relay, Power window master switch, Windshield wiper motor, Wiper/washer switch, No. 12 Fuse (in the under-dash fuse/relay box)
9	ACC SOCKET	10	10-4	ACC cut relay, Accessory power socket (USA: Base; Canada), Accessory power socket relay (USA: CR-L, CR Audio – A/C), Audio remote switch (USA: Base, CR Audio-A/C; Canada), Audio unit (USA: Base, CR Audio-A/C; Canada)



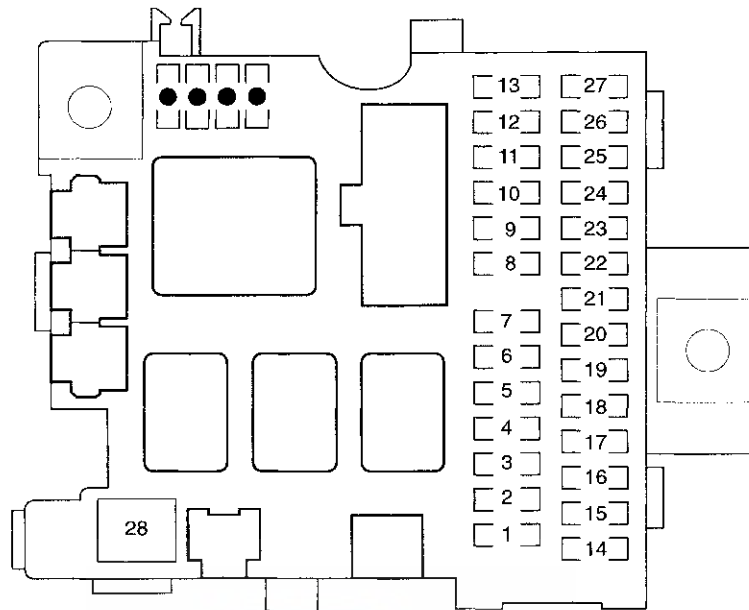

Fuse Number	Fuse Name	Amps	Page	Component or Circuit Protected
10	IGP (LAF)	7.5	10-11	A/F sensor relay
11	IGP (DBW)	7.5	10-11	Throttle actuator control module relay
12	WASHER MOTOR	15	10-9	Convertible top switch (USA: Base; Canada), Wiper/washer switch
13	FR WIPER AUTO STOP SIGNAL	7.5	10-9	Gauge assembly
14	DBW	15	10-12	Throttle actuator control module relay
15	LAF	15	10-12	A/F sensor relay
16	IG1 COIL	15	10-12	Ignition coil relay
17	POWER WINDOW-DR	20	10-5	Power window master switch
18	POWER WINDOW-AS	20	10-5	Convertible top control unit (USA: Base; Canada)
19	R/C MIRROR	7.5	10-7	DRL control unit, DRL sub control unit (USA), Power mirror switch, Rear window defogger relay
20	HEATER CONTROL COOLING FAN RELAY	7.5	10-7	A/C compressor clutch relay, A/C condenser fan relay, Blower motor relay, Heater control panel, Radiator fan relay, Recirculation control motor
21	TPMS	7.5	10-12	TPMS control unit

# Fuse/Relay Boxes

## - Under-dash Fuse/Relay Box (cont'd)

### Fuse-to-Components Index

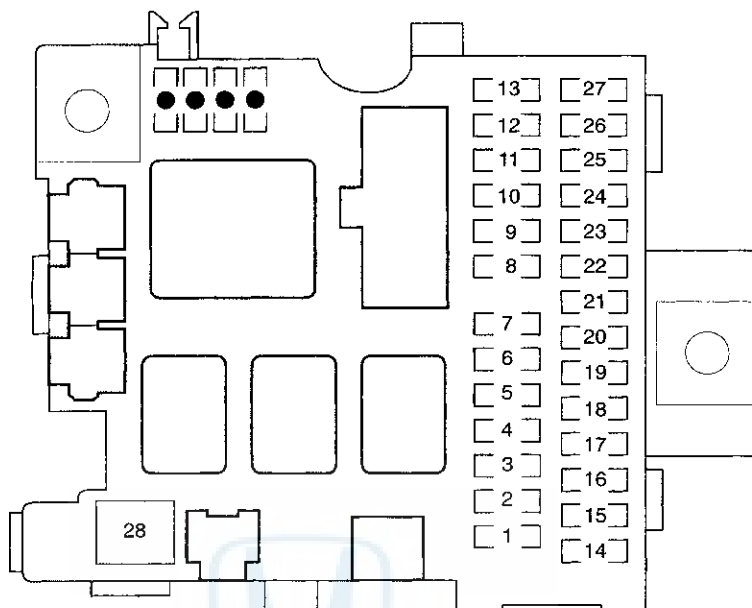

Fuse Number	Fuse Name	Amps	Page	Component or Circuit Protected
22	RADIO	15	10-12	Audio unit (USA: Base, CR Audio – A/C; Canada)
23	SMALL LIGHT	10	10-12	Taillight relay
24	INTERIOR LIGHT	7.5	10-12	Ceiling lights/spotlights, Trunk light
25	BACK-UP	7.5	10-8	Audio unit (USA: Base, CR Audio – A/C), Convertible top control unit (USA: Base; Canada), Gauge assembly, Heater control panel, Immobilizer control unit, Imoes unit, XM receiver (USA)
26	KEYLESS	15	10-8	Keyless door lock control unit, Trunk lid opener switch
27	RUNNING LIGHT	10	10-8	DRL control unit (Canada), DRL sub control unit (USA)
28	—	—	—	Not used



## Connector-to-Fuse/Relay Box Index

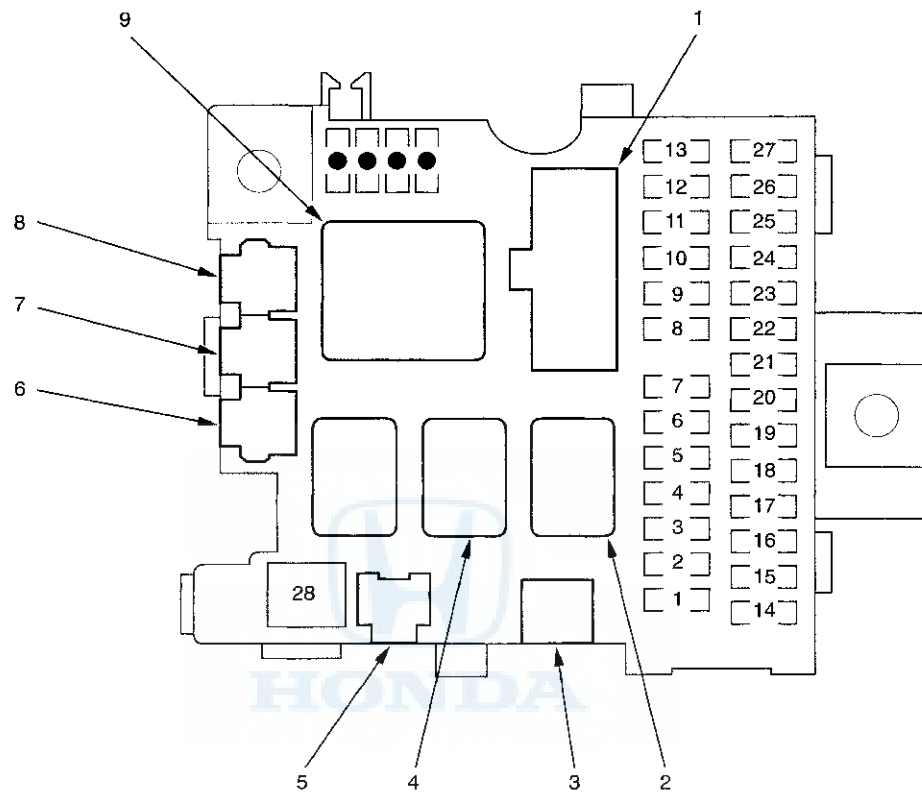

Ref	Socket	Cavities	Connects to
1	Connector B	7	Ignition switch lead (see page 203-17)
2	Taillight relay	5	
3	Connector A	2	SRS main wire harness (see page 203-17)
4	Starter cut relay	5	
5	MES connector	2	SRS main wire harness (see page 203-17)
6	Connector C	1	Option connector (IG2 Relay: see page 10-4)
7	Connector D	1	Option connector (B+ Fuse 42: see page 10-3)
8	Connector E	1	Option connector (Illumination (positive) circuit: see page 15)
9	Turn signal/hazard relay	3	

## Fuse/Relay Boxes

### - Auxiliary Under-hood Fuse Box

---

#### Fuse-to-Components Index

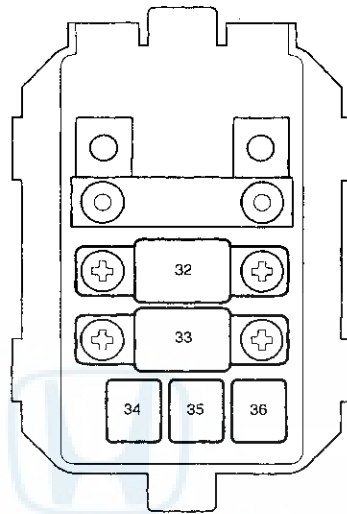

Fuse Number	Fuse Name	Amps	Page	Component or Circuit Protected
32	—	—	—	Not used
33	EPS	70	10	EPS control unit
34	RR DEF	20	10	Rear window defogger relay
35	—	—	—	Not used
36	—	—	—	Not used



### Connector-to-Fuse/Relay Box Index

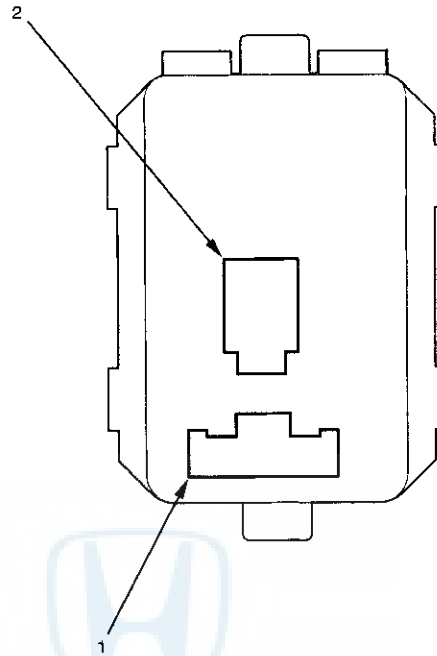

Ref	Socket	Cavities	Connects to
1	Connector B	3	Left engine compartment wire harness (see page 203-6)
2	Connector A	2	Left engine compartment wire harness (see page 203-6)

## Ground-to-Components Index

NOTE: All ground wires are BLK unless otherwise noted.

Ground	Page	Component or Circuit Grounded
G1	14-7	Battery
G2	14-7	Engine block (left side)
G3	14-7	Engine block (left side)
G4	14-7	EPS gearbox
G101	14	CKP sensor, CMP sensor, ECM (PG1 and PG2 are BLK; LG1 and LG2 are BRN/YEL), Ignition coils, Knock sensor shield, Rocker arm oil pressure switch (VTEC oil pressure switch), Secondary HO2S shield, Throttle actuator control module
G201	14-1	A/C condenser fan motor (USA: Base, CR Audio-A/C; Canada), Blower motor relay, ELD unit, EPS control unit, Radiator fan motor, Right front parking/side marker light, Right front turn signal light, Right side turn signal light, Windshield washer motor
G301	14-2	Brake fluid level switch, Left front parking/side marker light, Left front turn signal light, Intermittent wiper relay, Left side turn signal light, Windshield wiper motor
G303	14-2	VSA modulator-control unit (2 wires)
G351	14-7	EPS control unit
G401	14-3	Accessory power socket relay (USA: CR, CR Audio – A/C), Clutch interlock switch, Clutch pedal position switch, Combination light switch, DLC, DRL sub control unit (USA), Ignition key switch, Steering angle sensor, TPMS control unit, Turn signal/hazard relay, Wiper/washer switch
G402	14-4	Blower power transistor, Convertible top control unit (3 wires) (USA: Base; Canada), DRL control unit (2 wires), EPS control unit, Heater control panel, Rear window defogger switch
G501	14-5	Audio remote switch (USA: Base, CR Audio – A/C; Canada), Convertible top control unit (USA: Base; Canada), Cruise control main switch, Driver's door key cylinder switch, Driver's door latch, Engine start switch, Gauge assembly (2 wires), Keyless door lock control unit, Left headlight (low beam), MES connector, Passenger's power window switch, Power mirror switch, Power window master switch, Right headlight (low beam), VSA OFF switch
G502	14-5	Audio unit (2 wires) (USA: Base, CR Audio – A/C; Canada)
G601	14-6	Accessory power socket, Convertible top disable switch (removable hardtop), Driver's seat belt buckle switch, Fuel tank unit, High mount brake light, Noise condenser, Passenger's seat belt buckle switch, Passenger's weight sensor unit, Rear window defogger (softtop), Trunk lid opener solenoid/latch switch, XM receiver (USA)
G602	14-6	Back-up light (left/right), Brake/side marker/taillight (left/right), License plate light, Rear turn signal light (left/right)
G801	14-7	SRS unit (2 wires)
G901	14-6	Convertible top disable switch (removable hardtop)
G902	14-6	Rear window defogger (removable hardtop)



# Power Distribution

- Auxiliary Under-hood Fuse Box – Fuses 33 and 34, Main Under-hood Fuse/Relay Box – Fuses 41, 52, 53 and 55

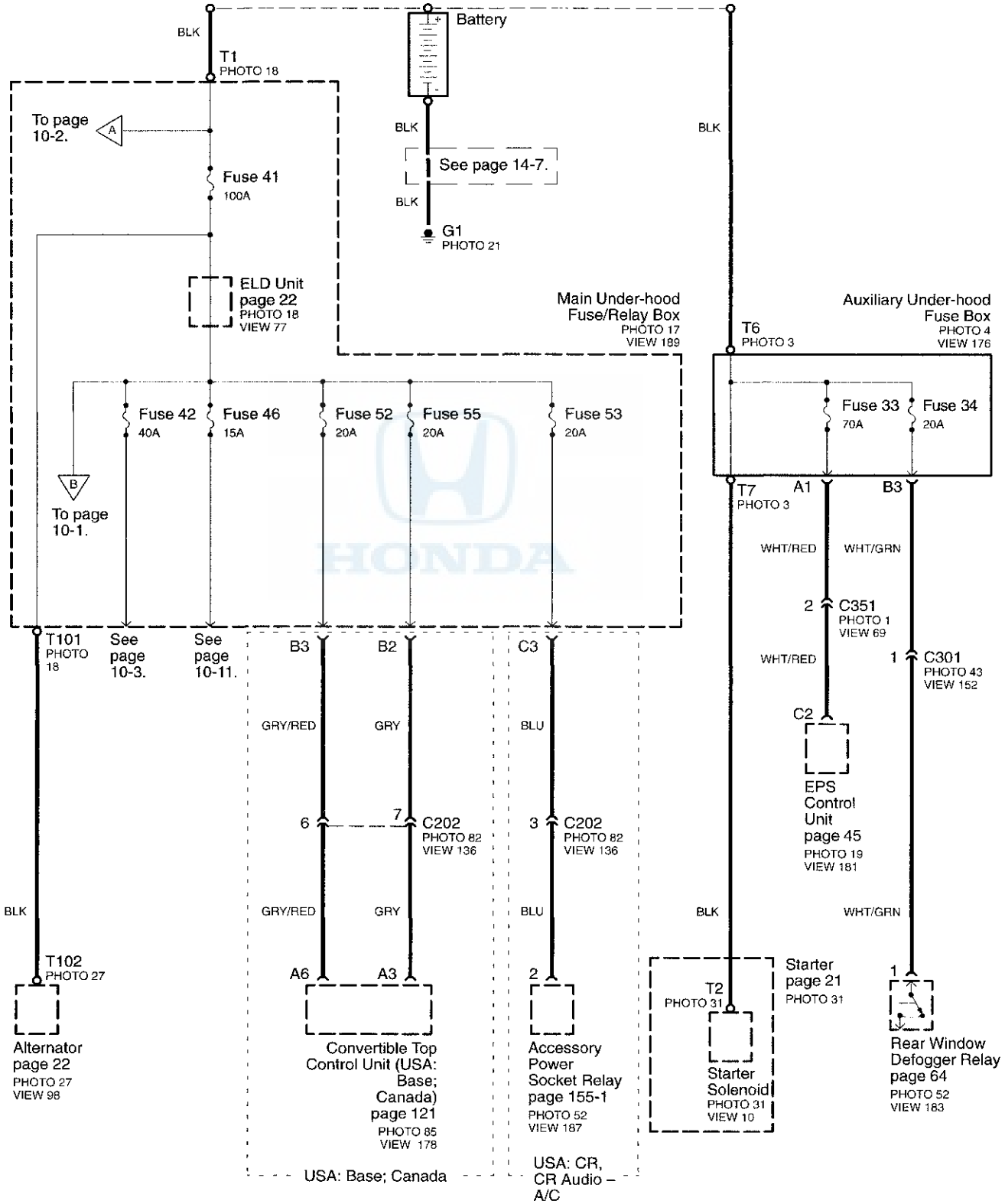





# - Main Under-hood Fuse/Relay Box – Fuses 51, 54, 56, 57, 58 and 59 -

Main Under-hood  
Fuse/Relay Box  
PHOTO 17  
VIEW 189

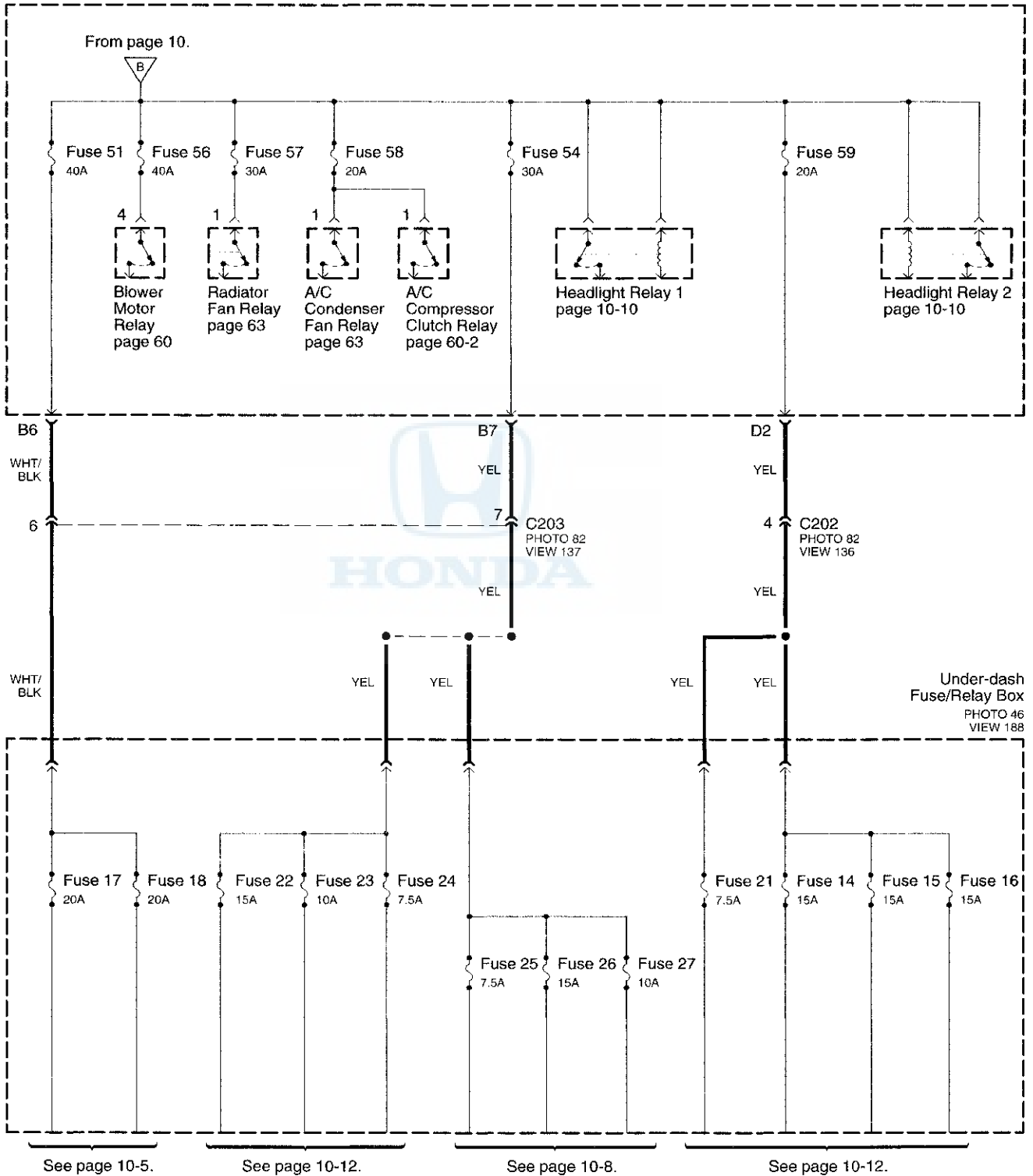

# Power Distribution

## - Main Under-hood Fuse/Relay Box – Fuses 47, 48, 49 and 50

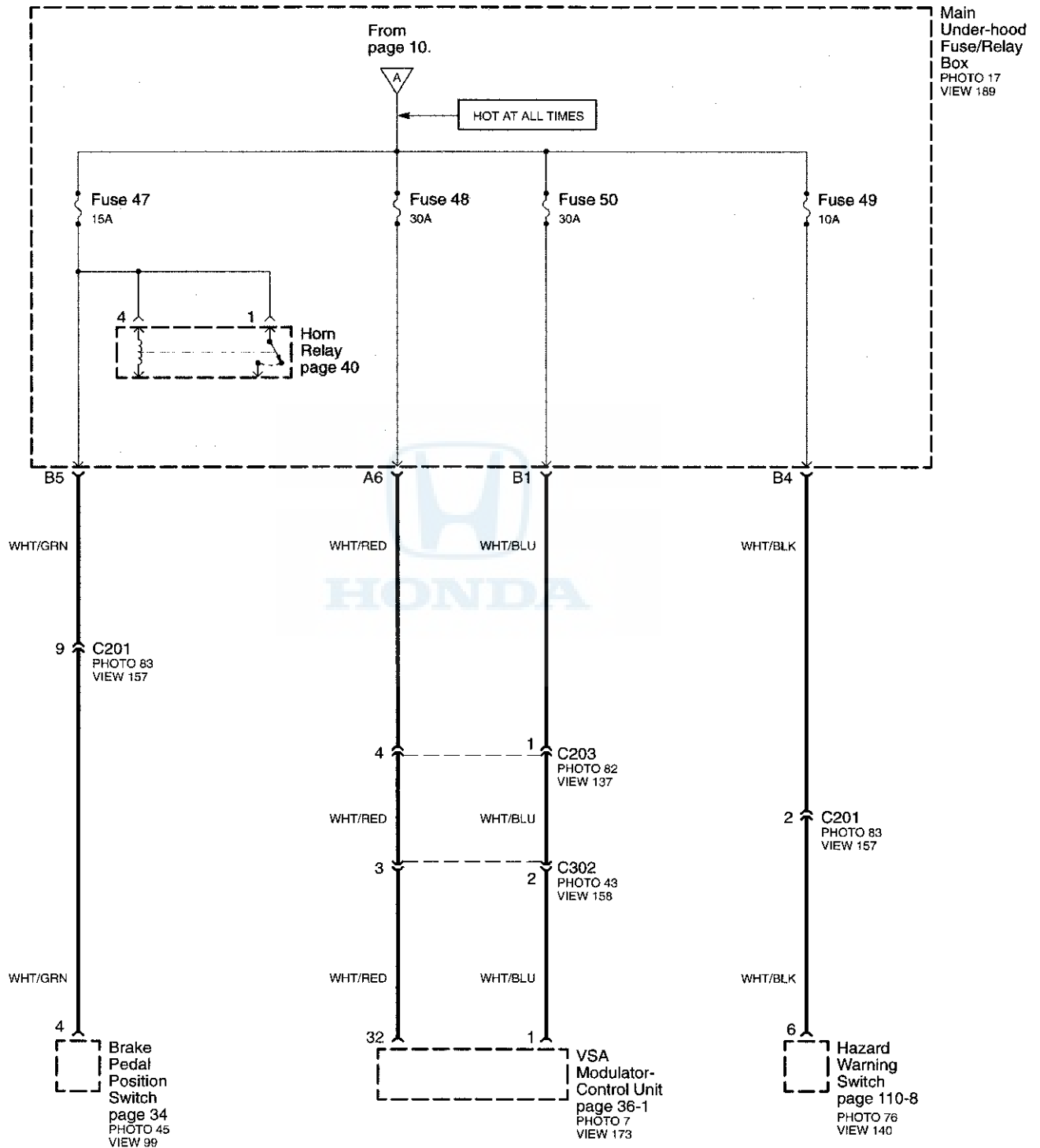



# - Main Under-hood Fuse/Relay Box – Fuse 42 and Ignition Switch

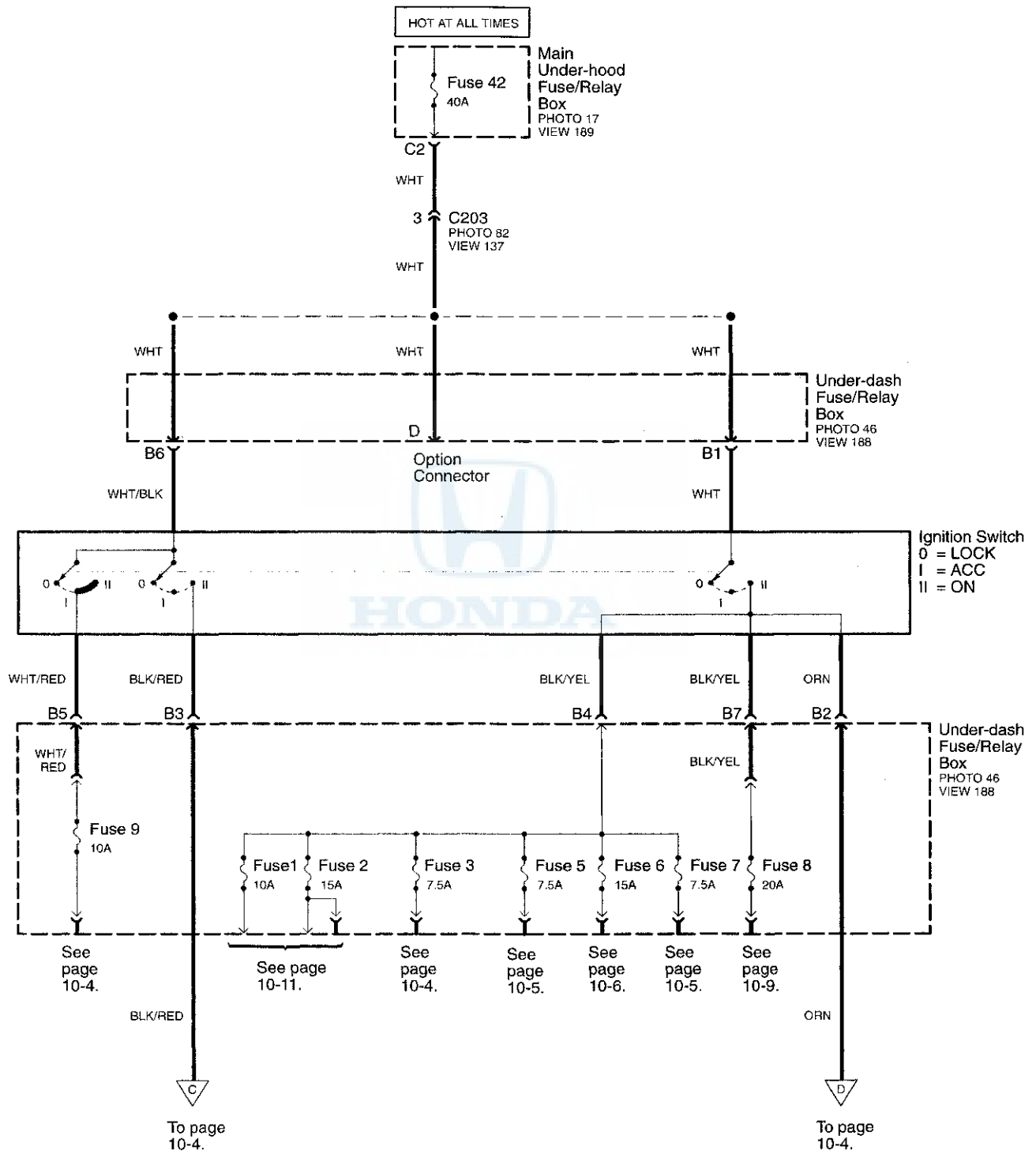

# Power Distribution

## - Under-dash Fuse/Relay Box – Fuses 3 and 9

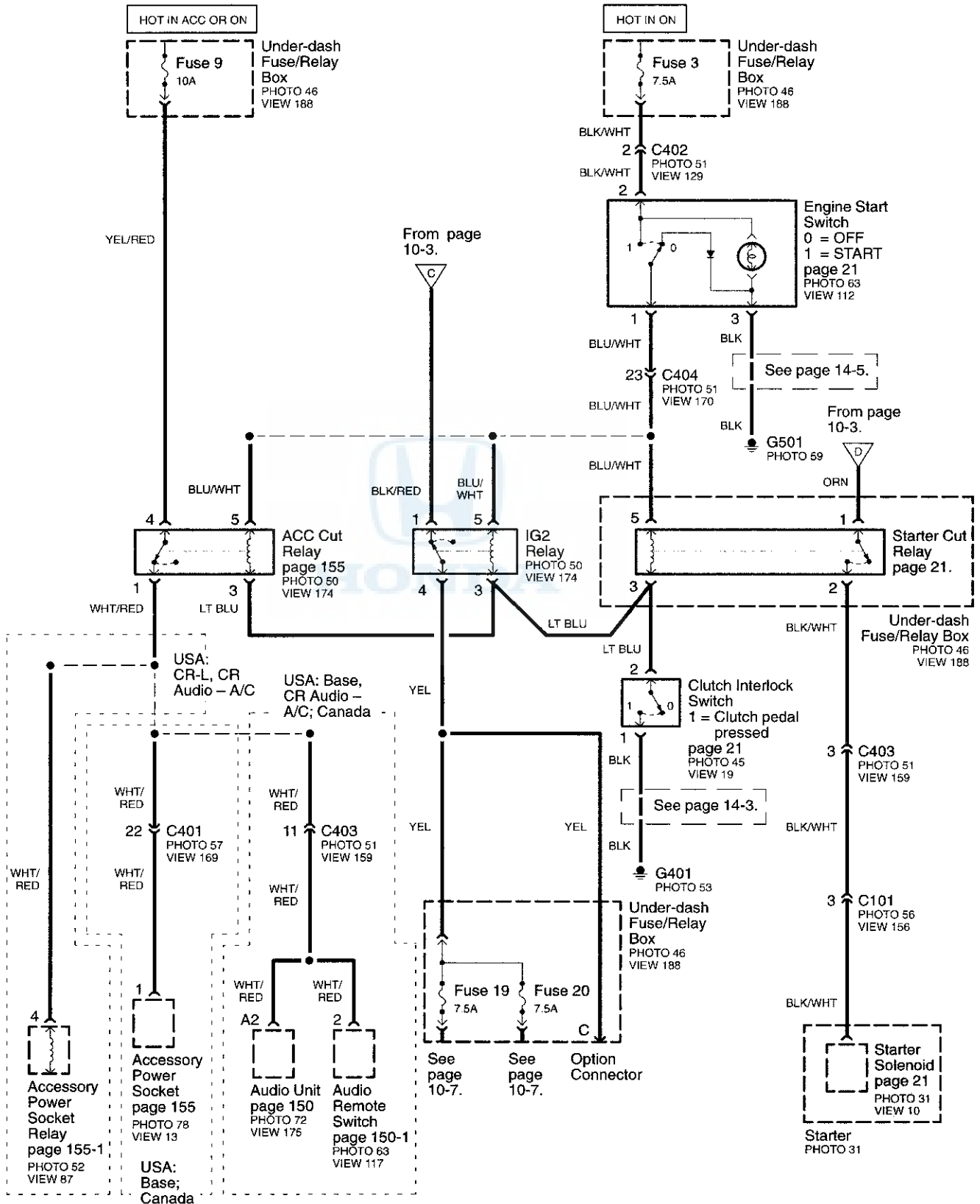





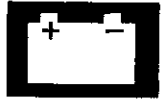

## - Under-dash Fuse/Relay Box – Fuse 19

NOTE: See page 10-4 for details.

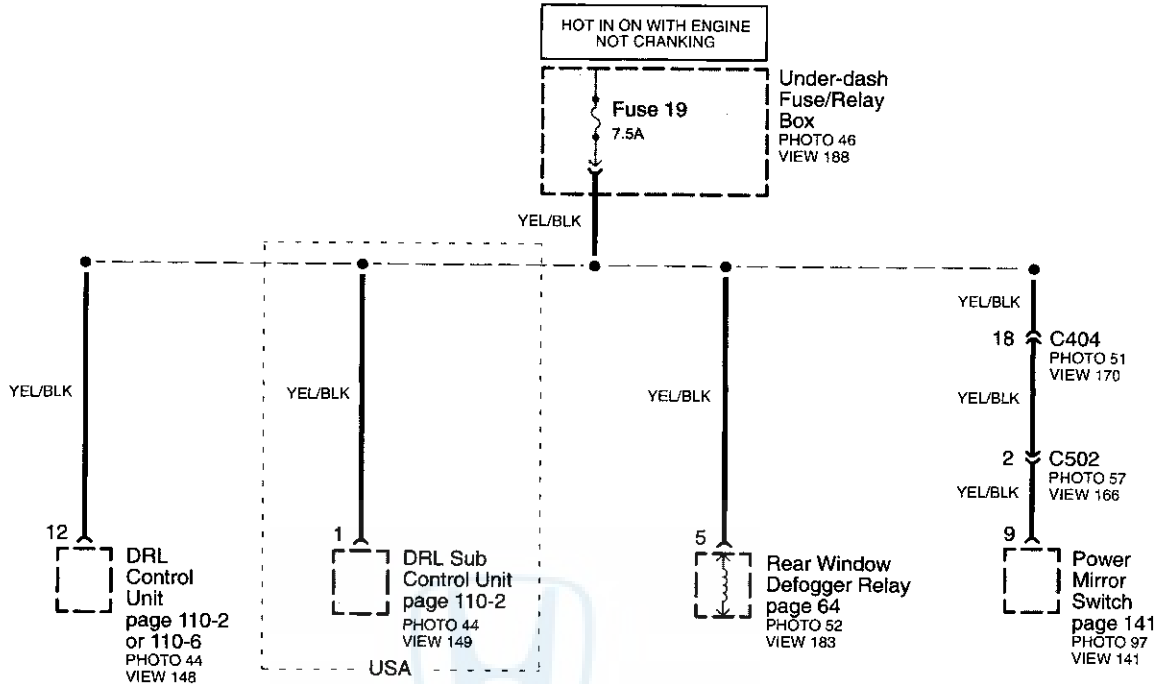

## - Under-dash Fuse/Relay Box – Fuse 20

NOTE: See page 10-4 for details.

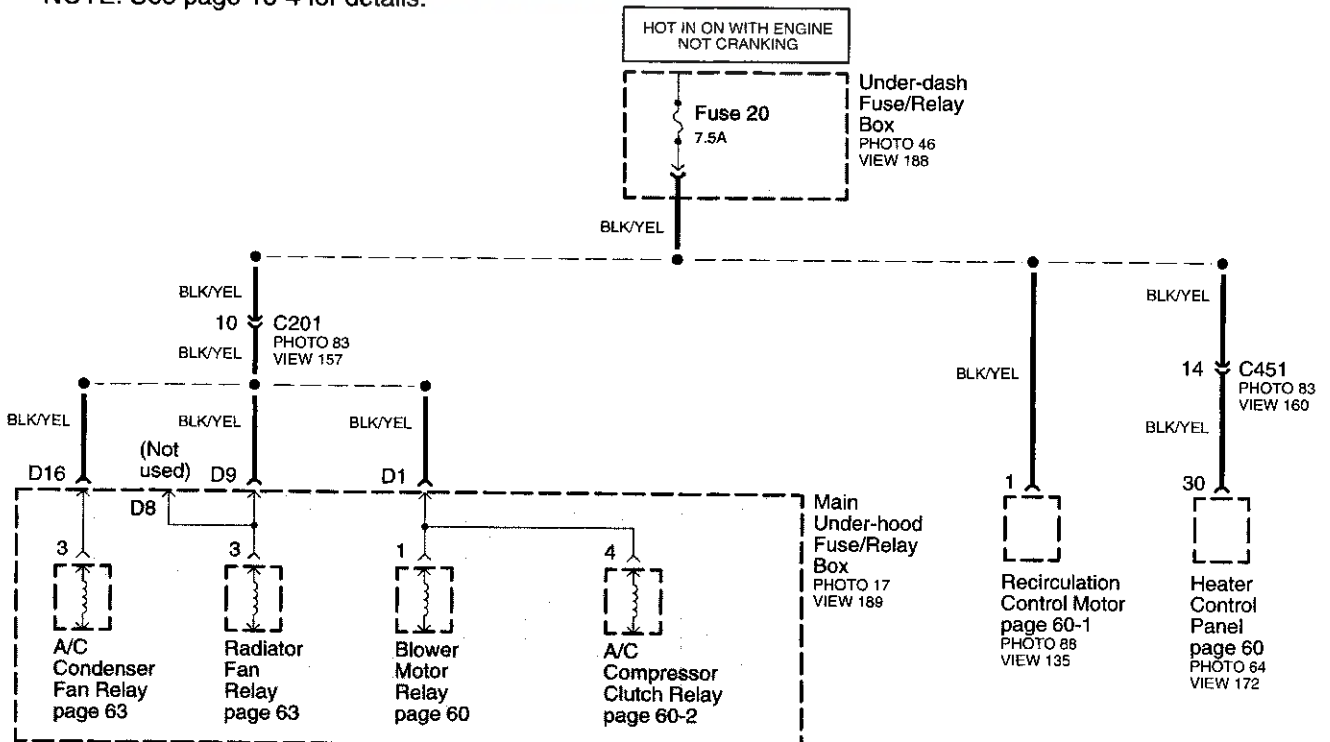

# Power Distribution

## - Under-dash Fuse/Relay Box – Fuses 25, 26 and 27

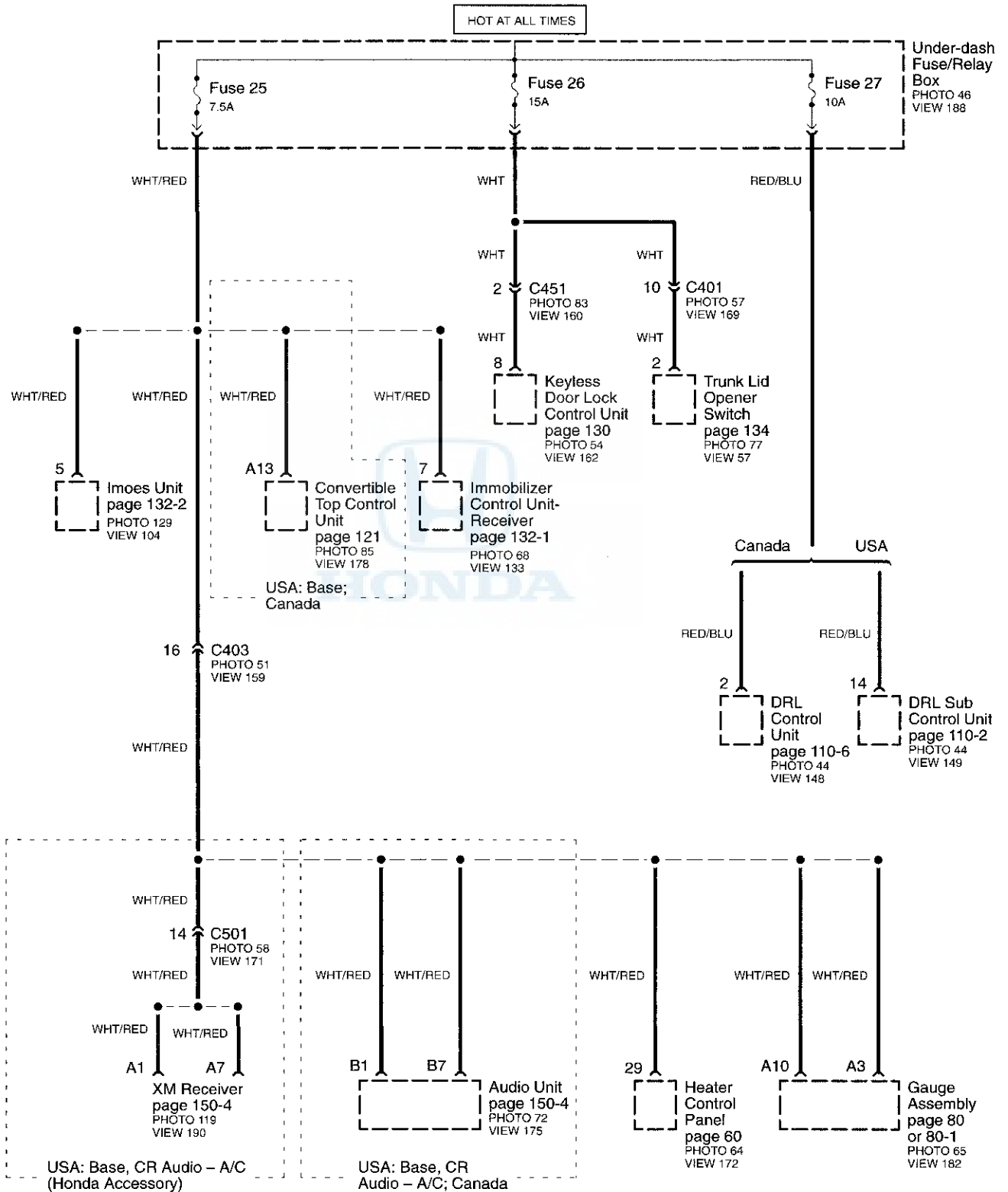





# - Under-dash Fuse/Relay Box – Fuses 8, 12 and 13

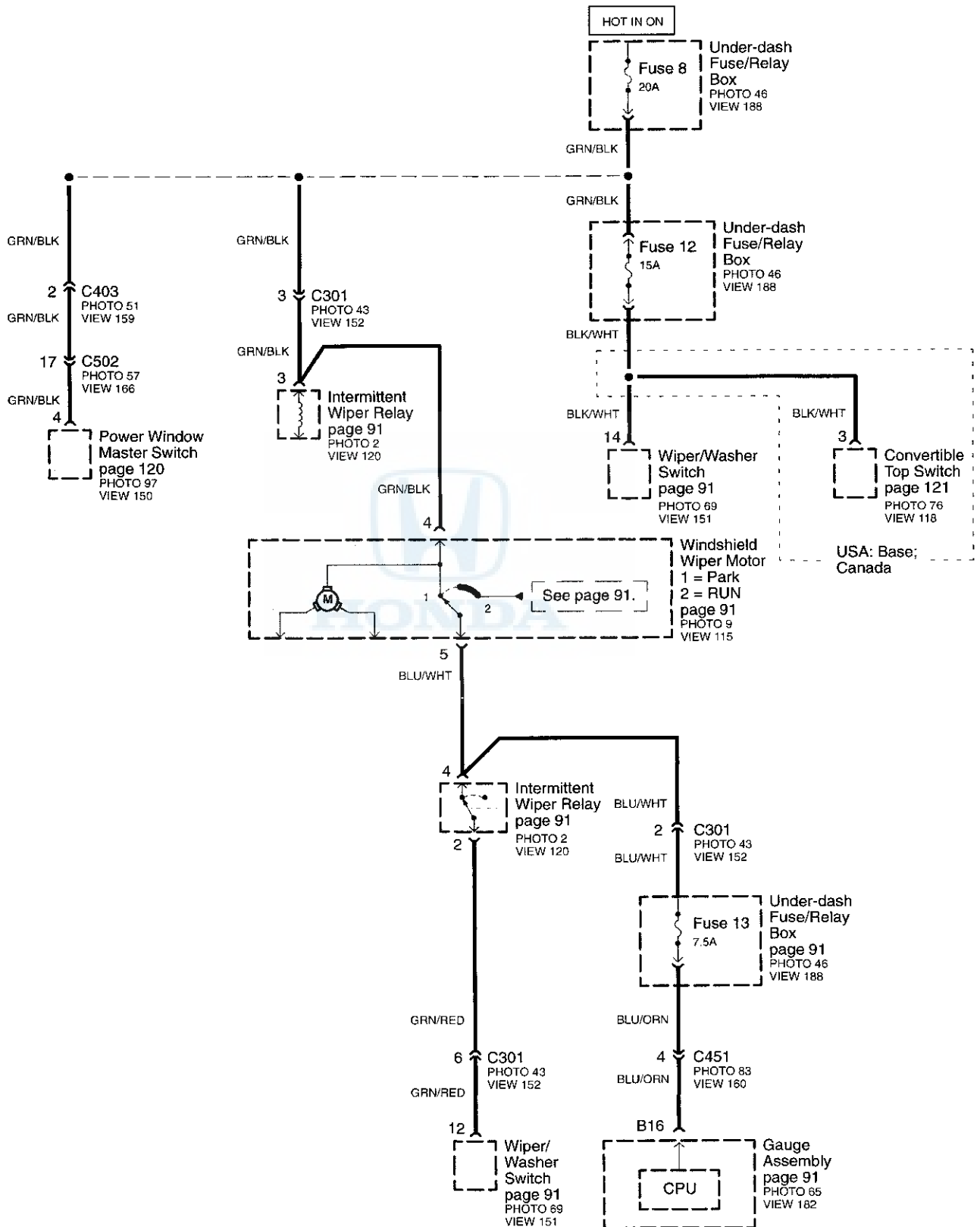

# Power Distribution

## - Main Under-hood Fuse/Relay Box – Fuses 43, 44 and 45

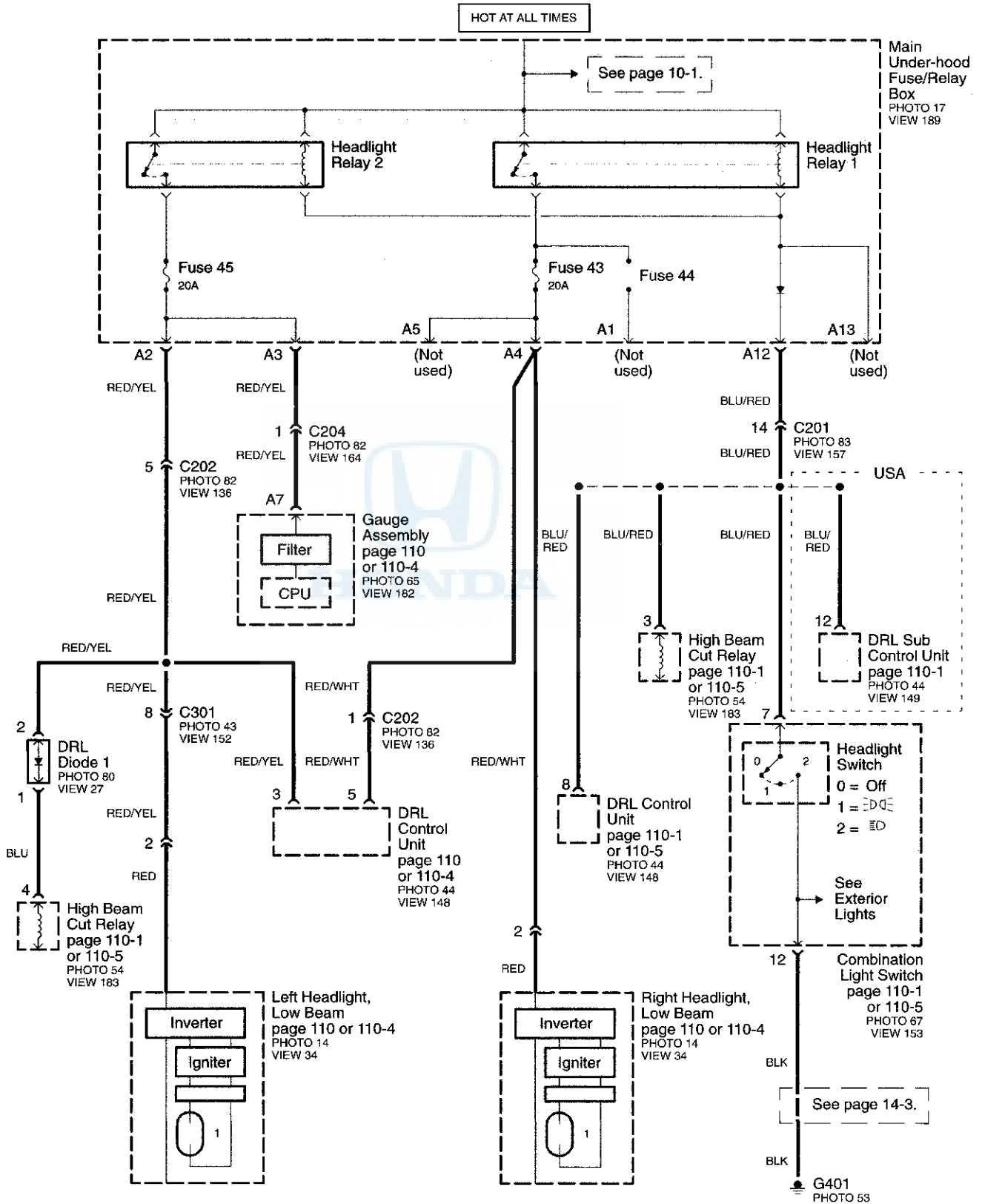



# - Main Under-hood Fuse/Relay Box – Fuse 46, Under-dash Fuse/Relay Box – Fuses 1, 2, 10 and 11

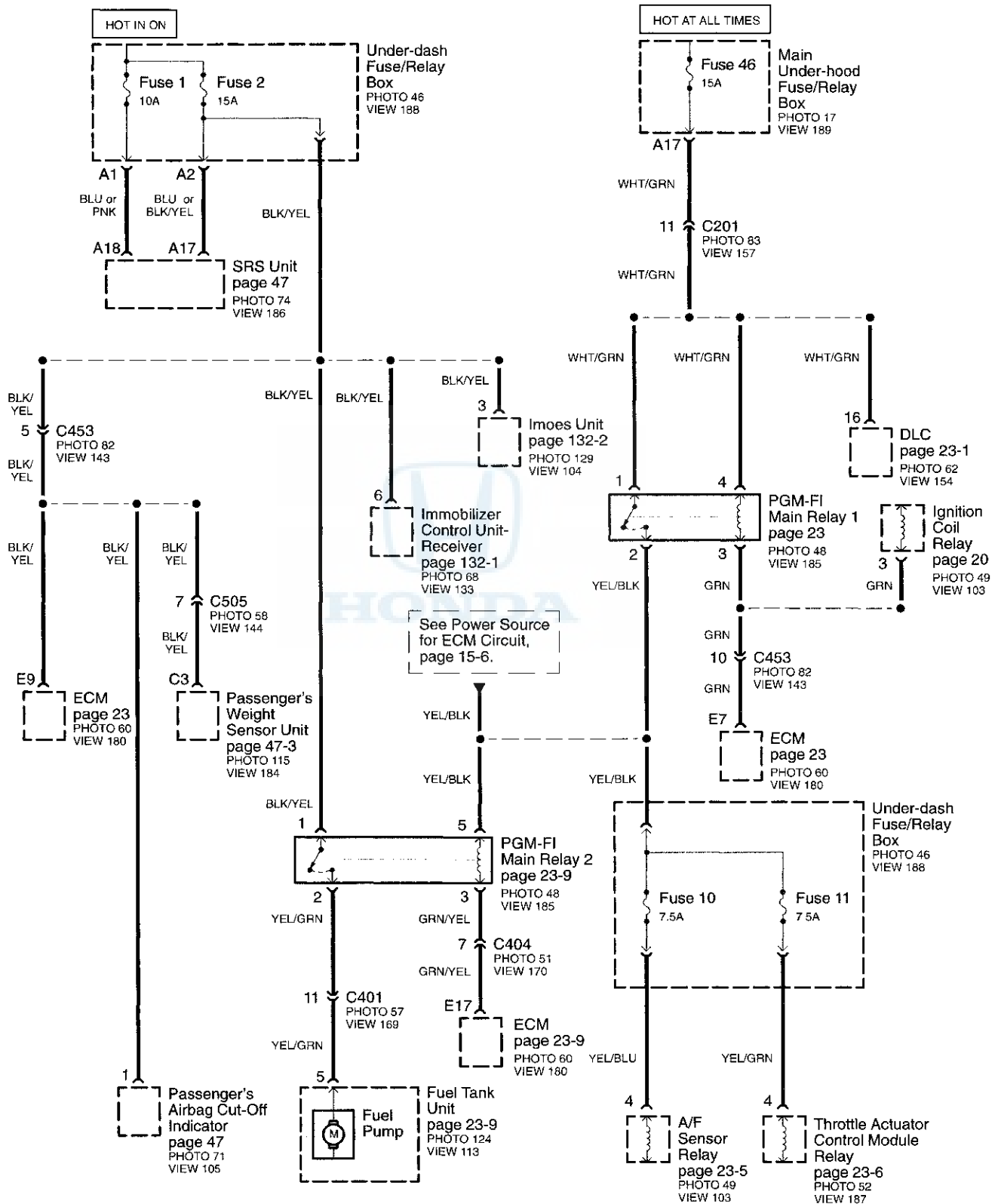

# Power Distribution

## - Under-dash Fuse/Relay Box – Fuses 14, 15, 16 and 21

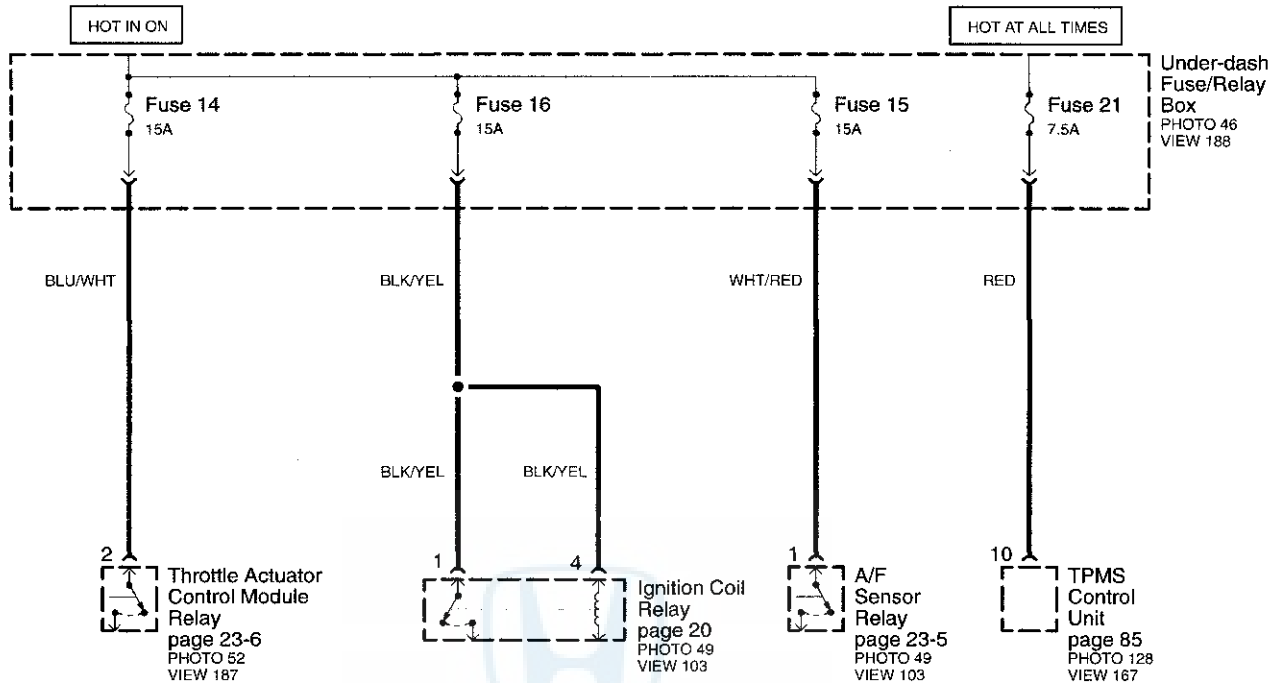

## - Under-dash Fuse/Relay Box – Fuses 22, 23 and 24

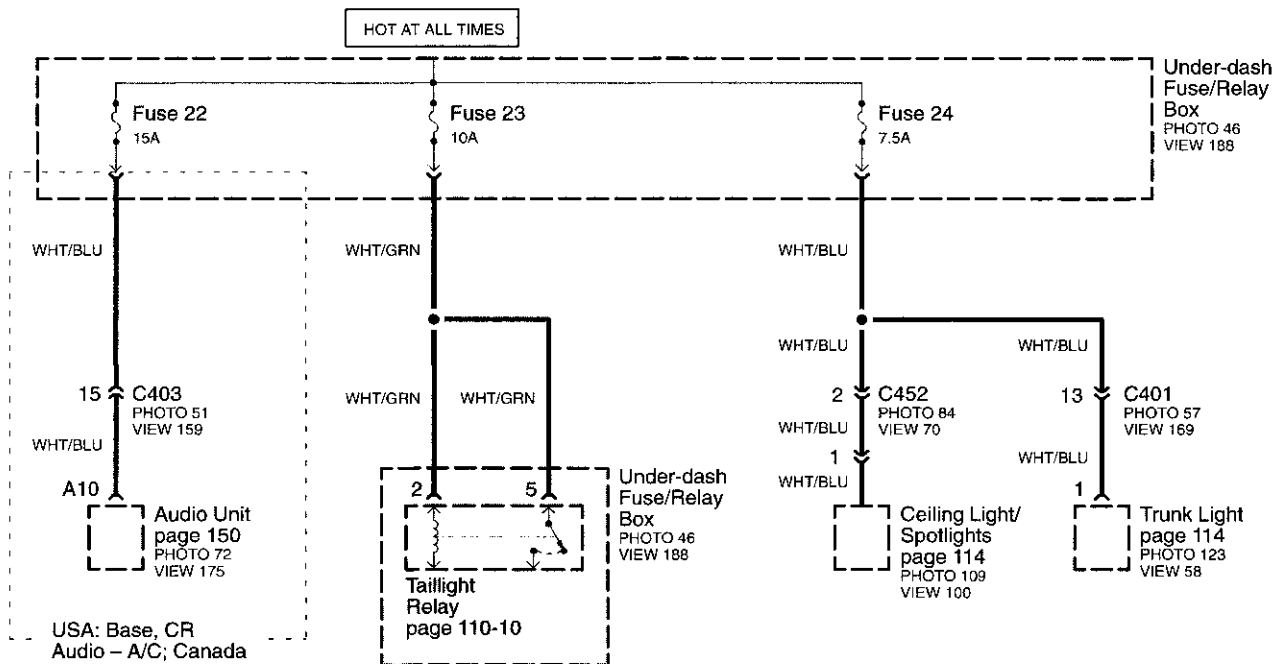



# Ground Distribution

## - G101

NOTE: Wires shown without color codes are black.

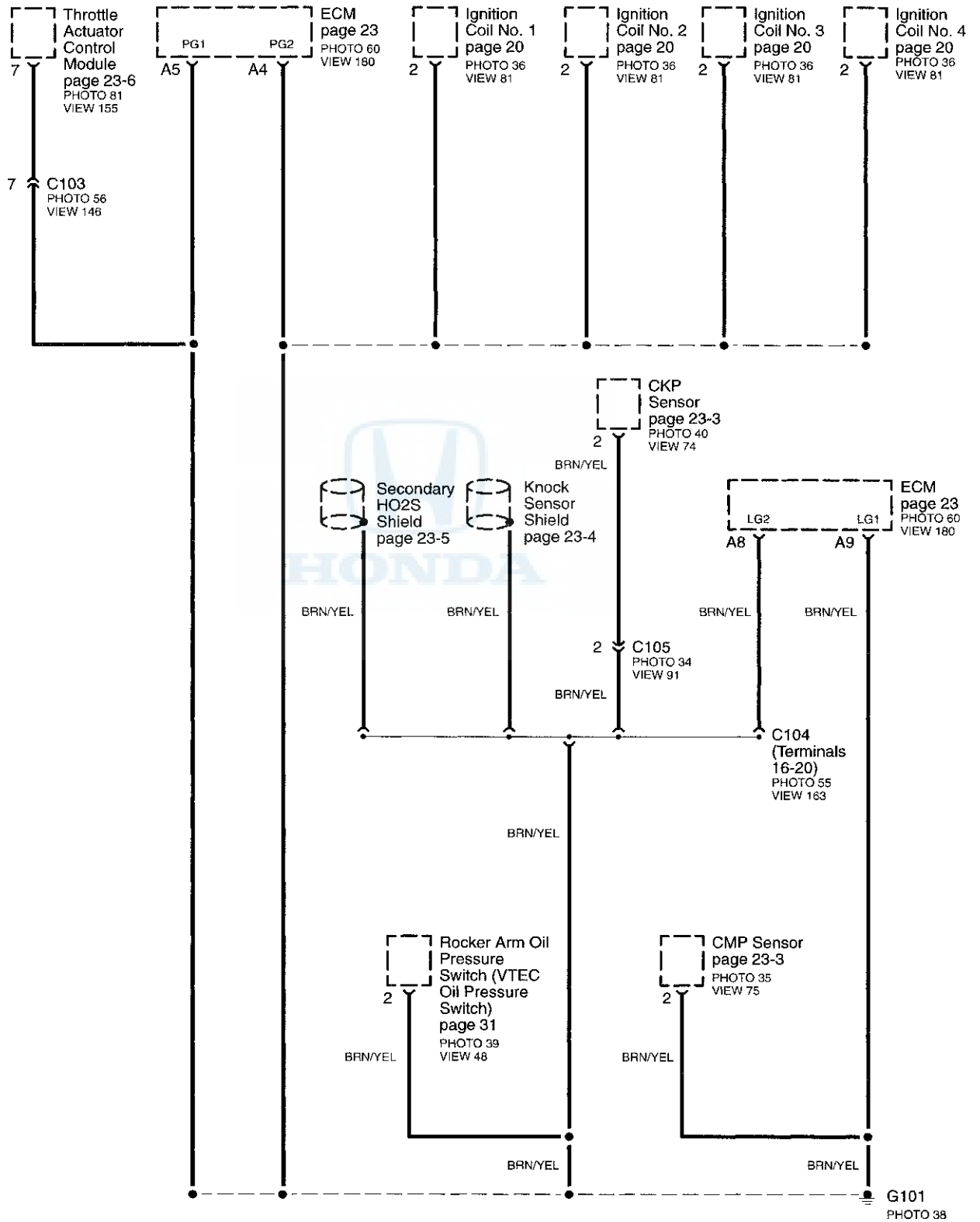



**G201**

NOTE: Wires shown without color codes are black.

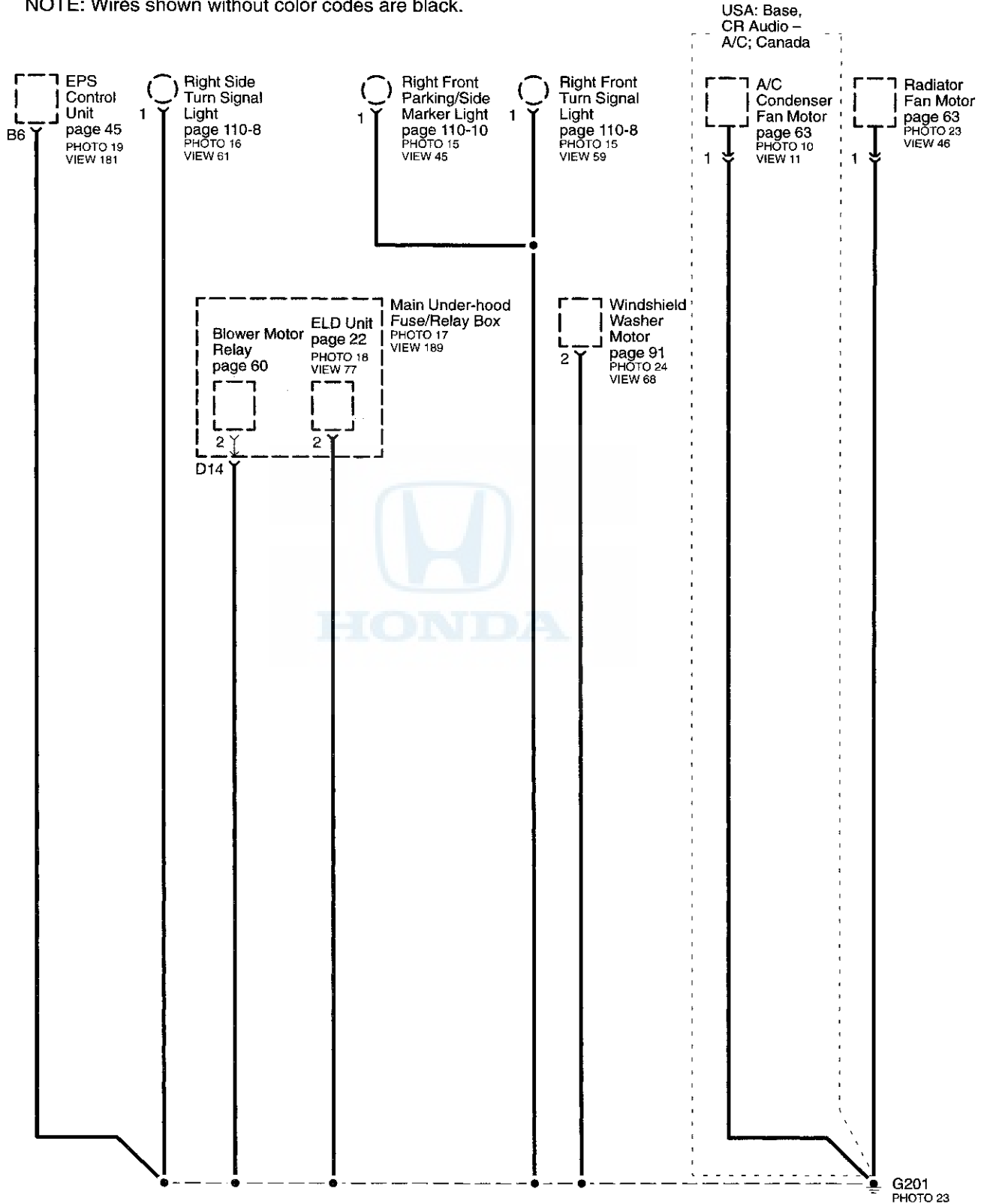

G201  
PHOTO 23

# Ground Distribution

## - G301

NOTE: Wires shown without color codes are black.

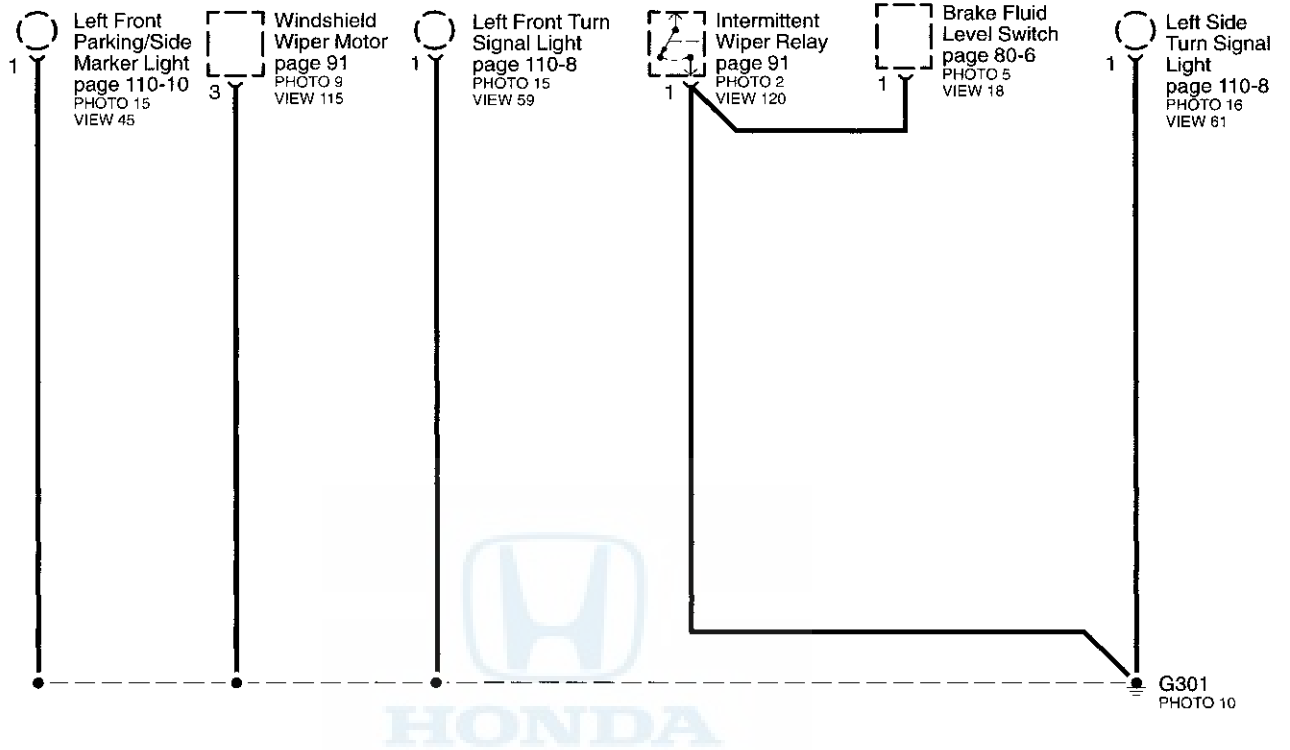

## - G303

NOTE: Wires shown without color codes are black.

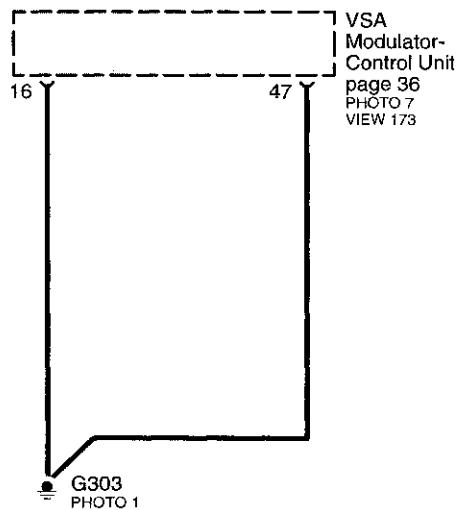





# G401

NOTE: Wires shown without color codes are black.

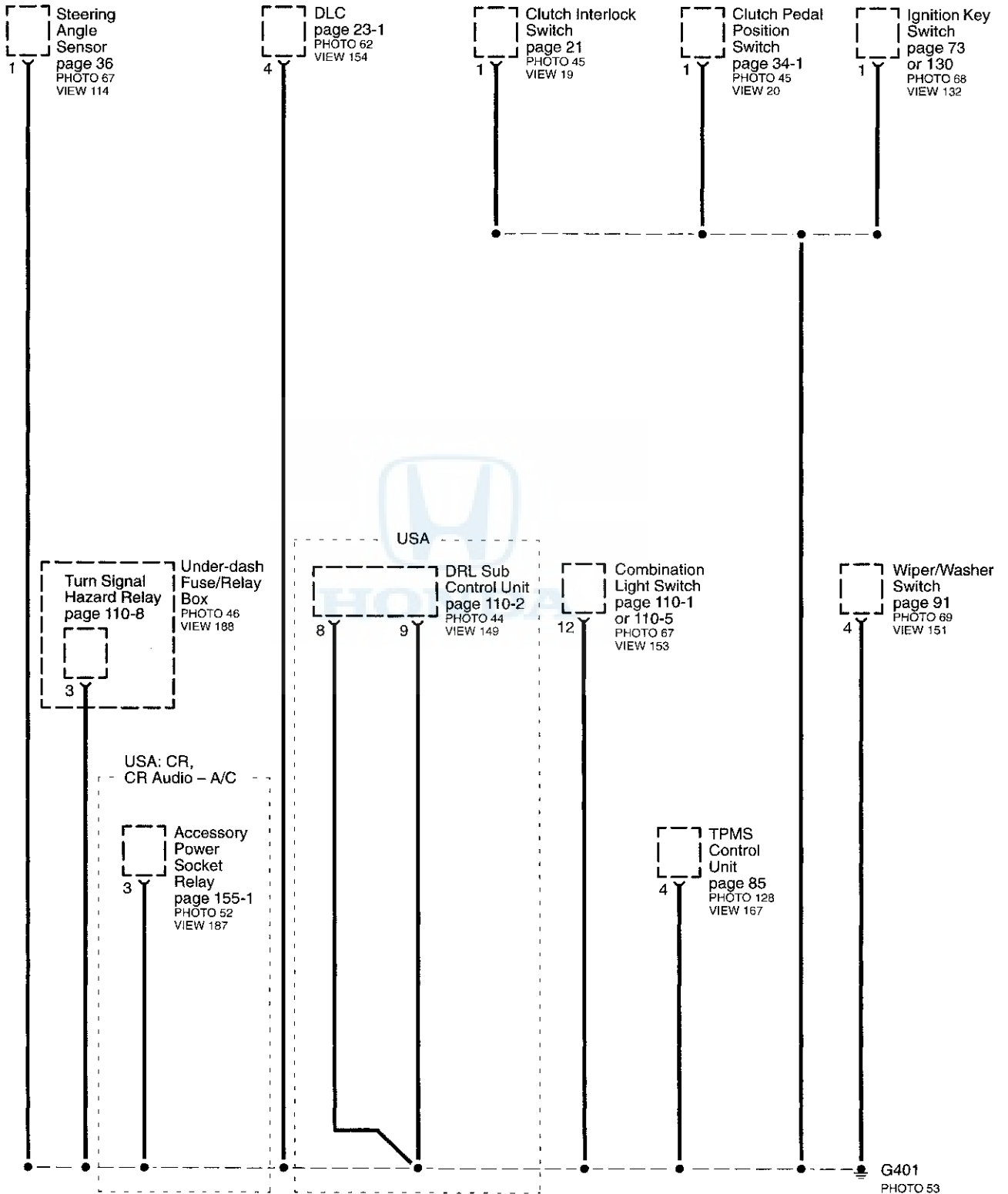

# Ground Distribution

## - G402

NOTE: Wires shown without color codes are black.

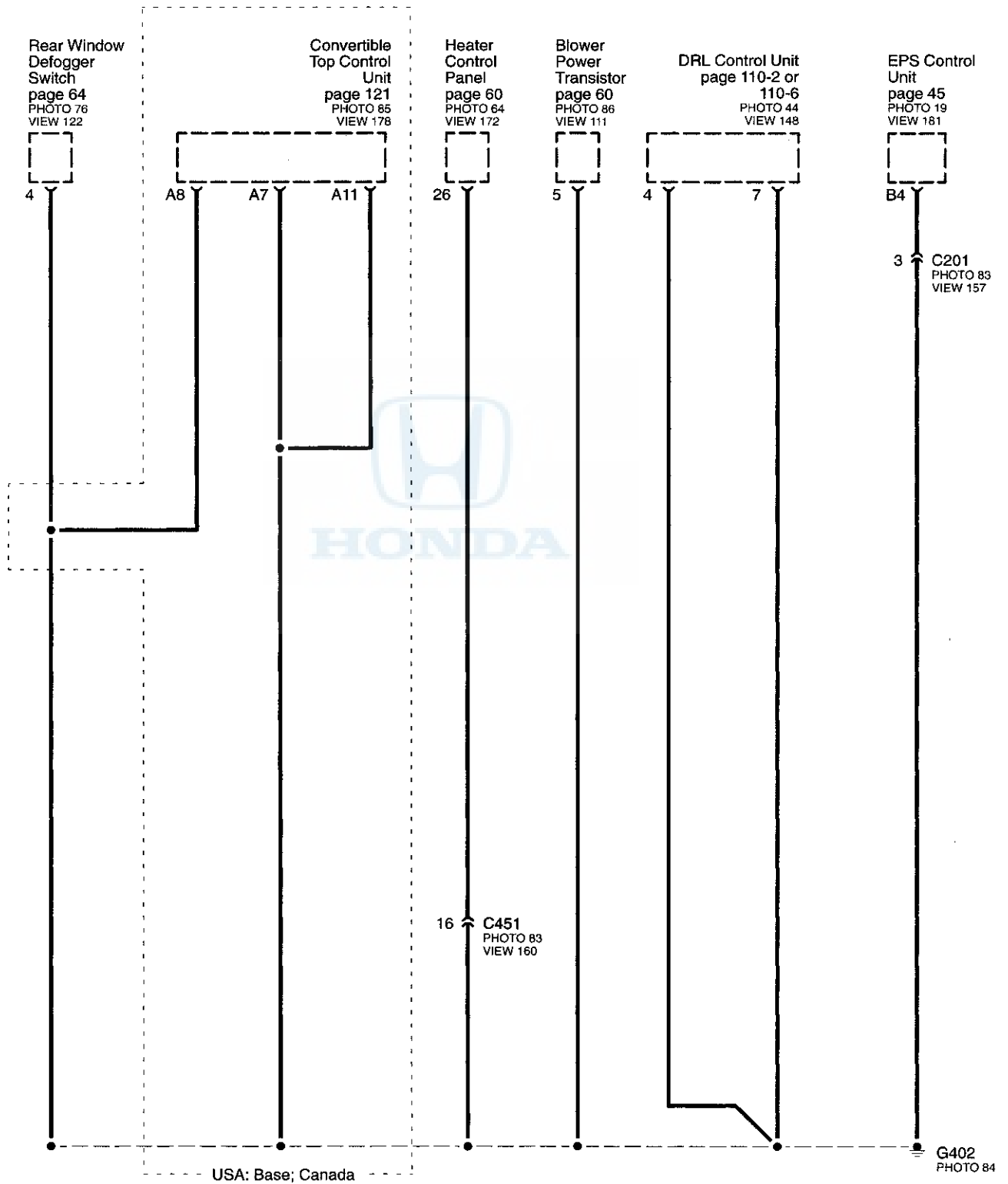



# - G501 and G502

NOTE: Wires shown without color codes are black.

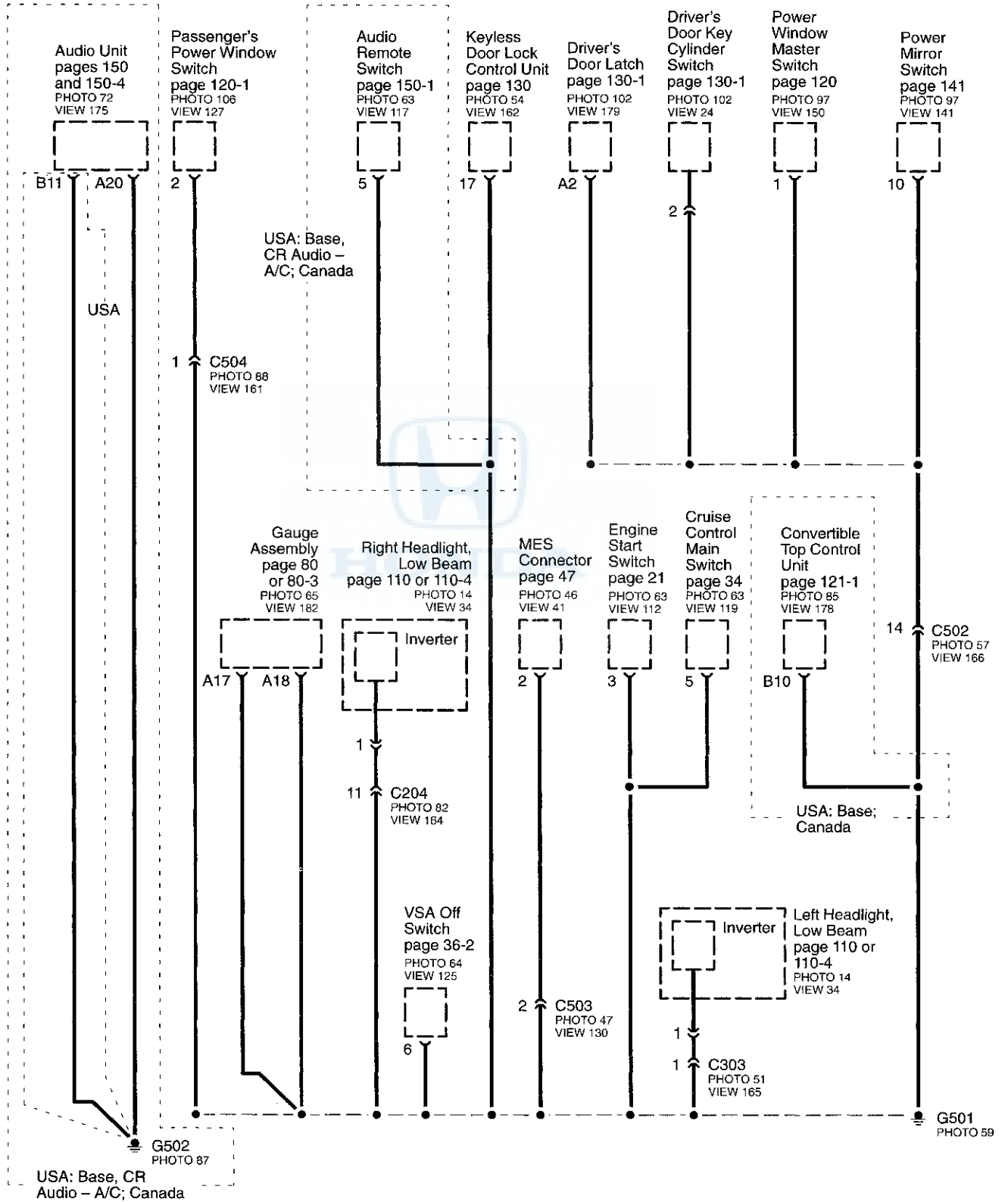

# Ground Distribution

## - G601, G901 (Removable Hardtop) and G902 (Removable Hardtop)

NOTE: Wires shown without color codes are black.

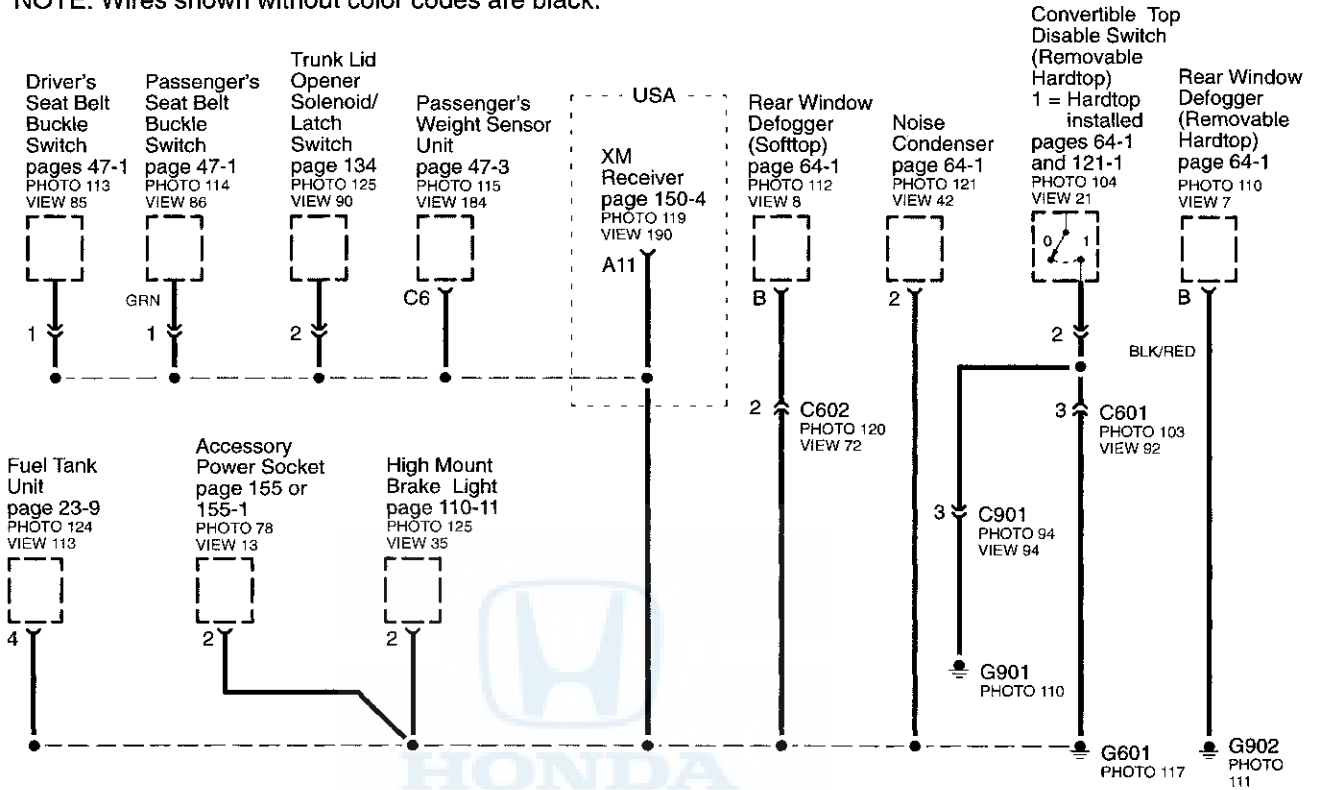

## - G602

NOTE: Wires shown without color codes are black.

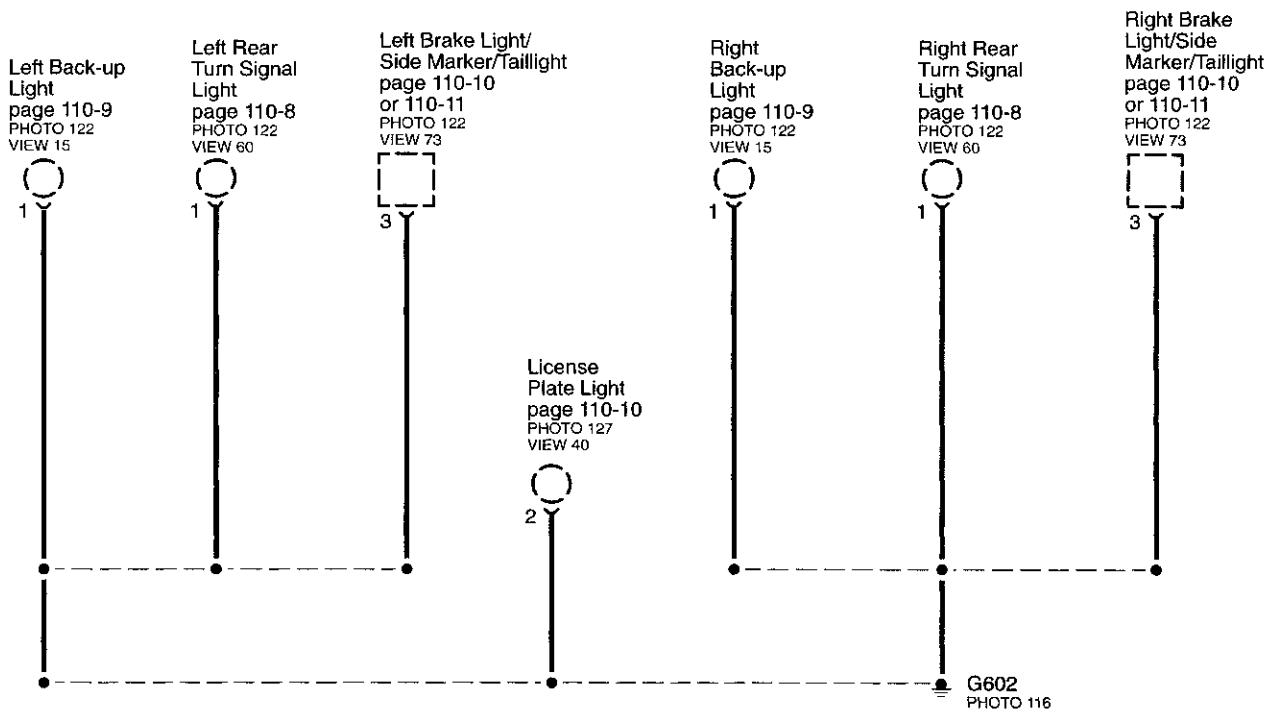

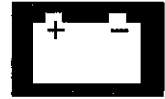

## - G1, G2, G3, G4, G351 and G801

NOTE: Wires shown without color codes are black.

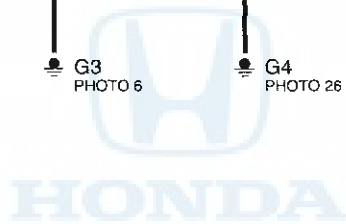
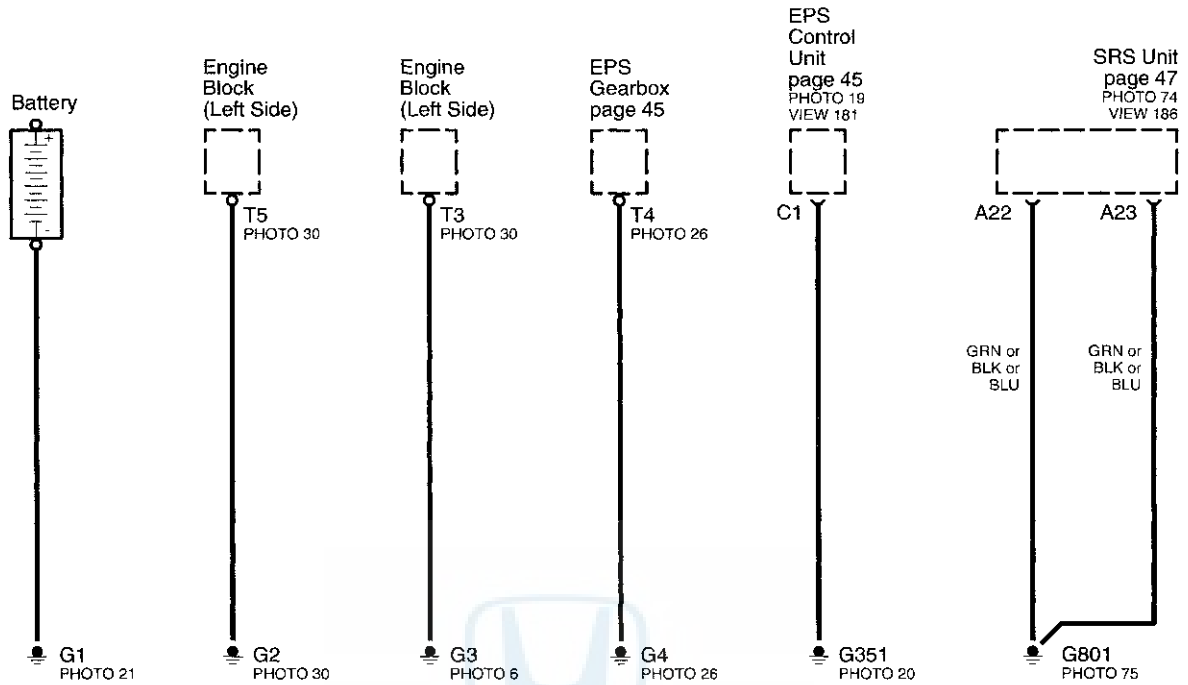

# Splice and Junction Connector Details

## - Illumination (Positive)

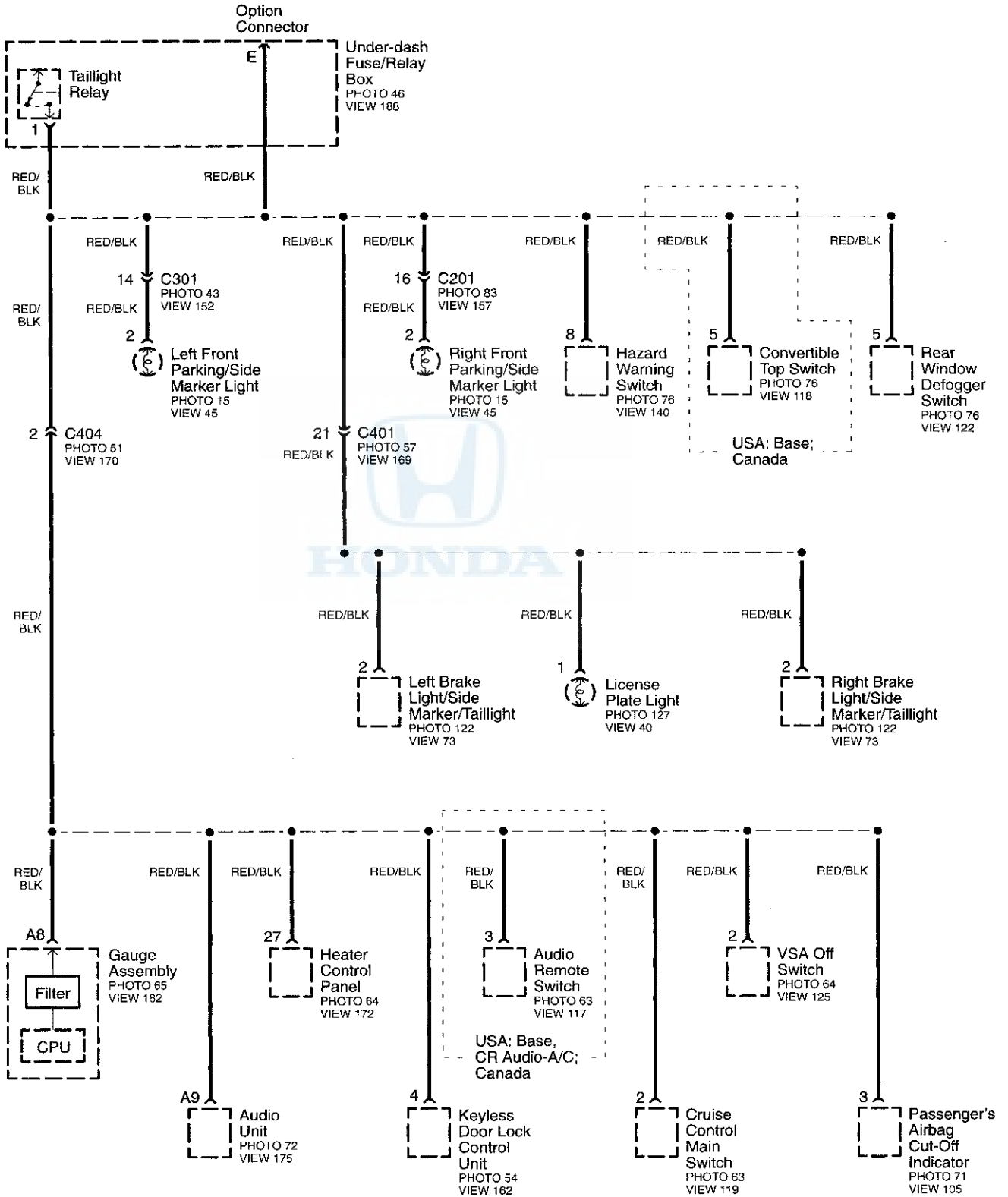



## - Illumination (Negative)

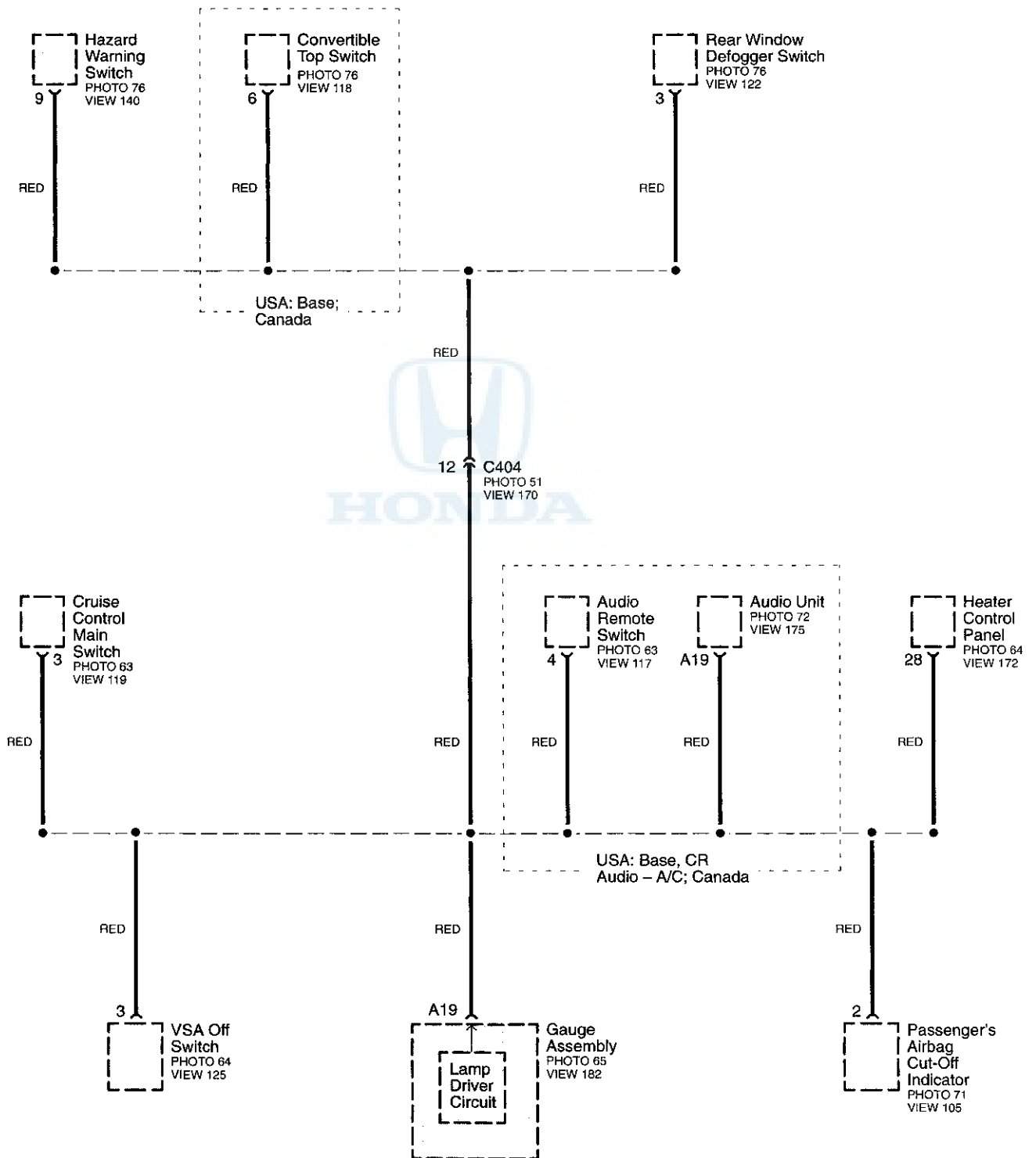

# Splice and Junction Connector Details

## - Brake Pedal Position

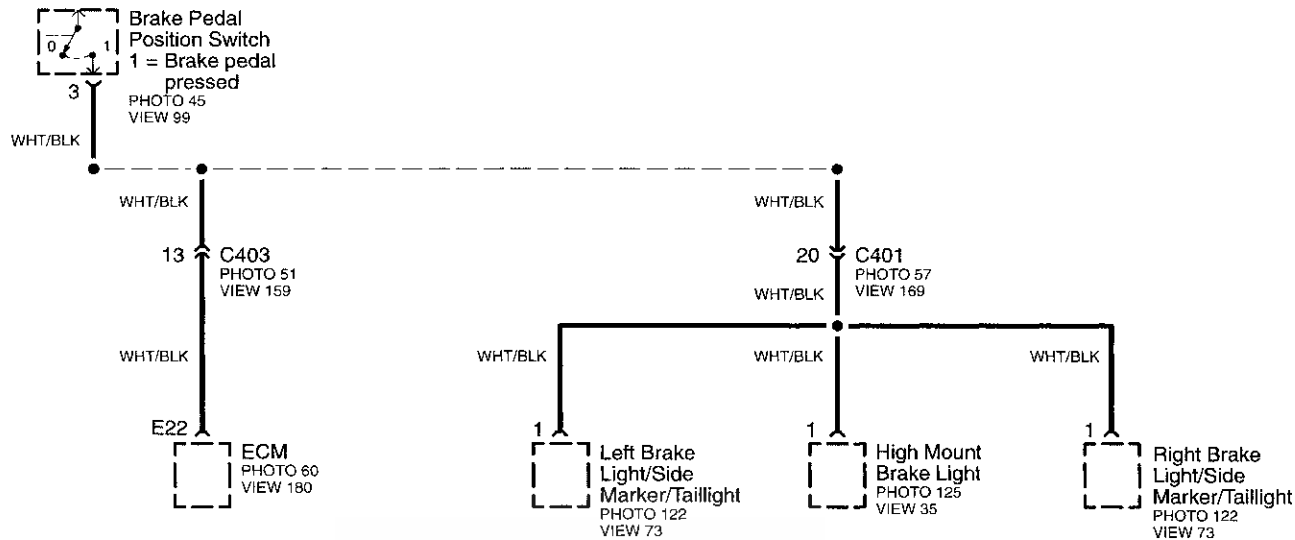

## - Parking Brake Position

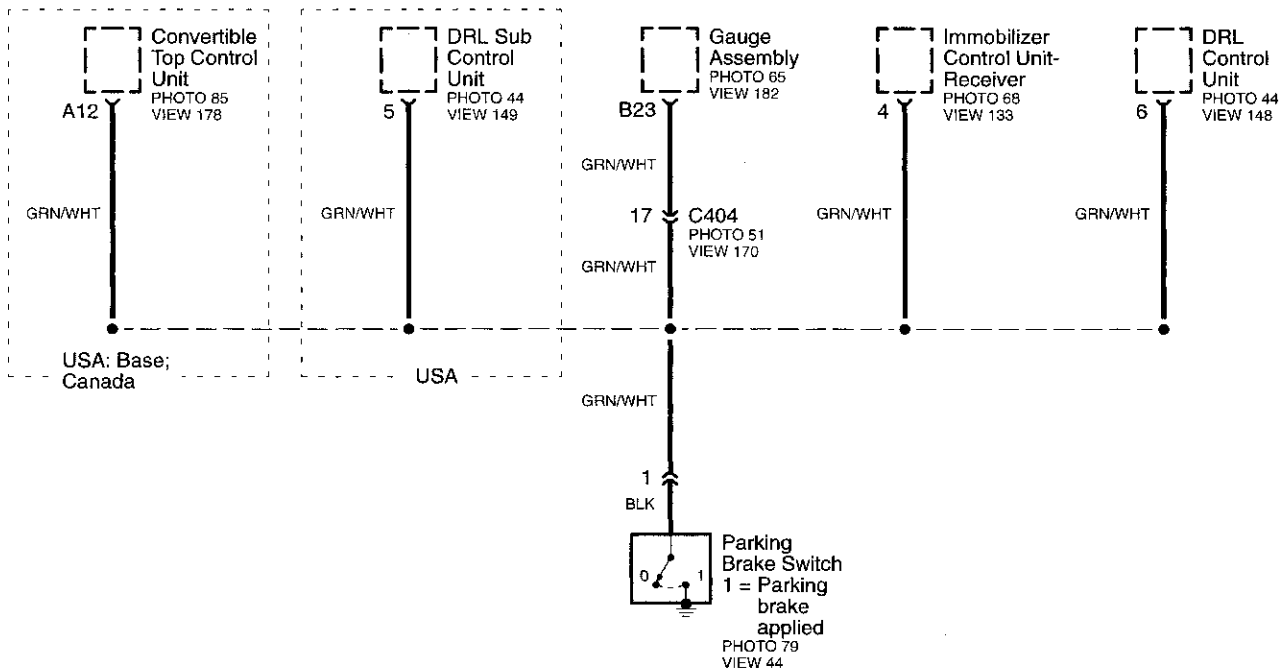





## - Horn Relay Control

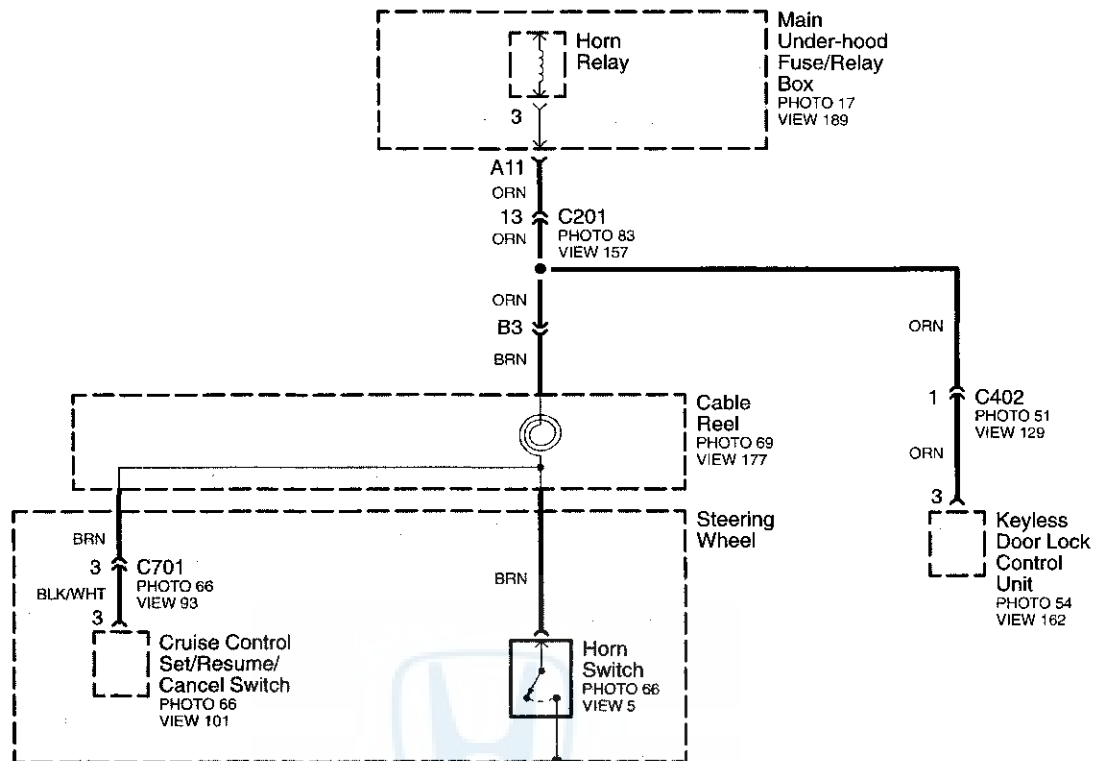

## - Trunk Lid Position

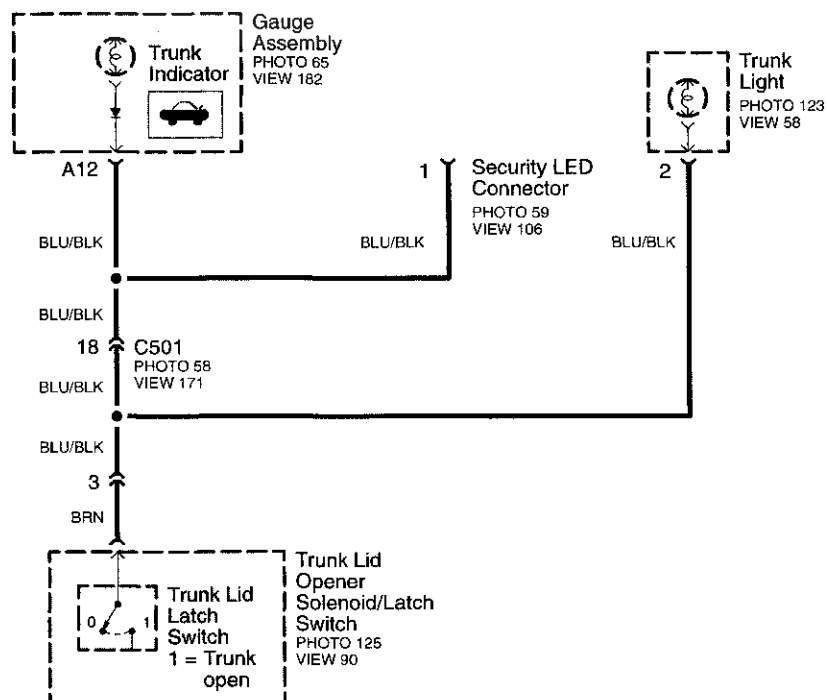

# Splice and Junction Connector Details

## - Intermittent Wiper

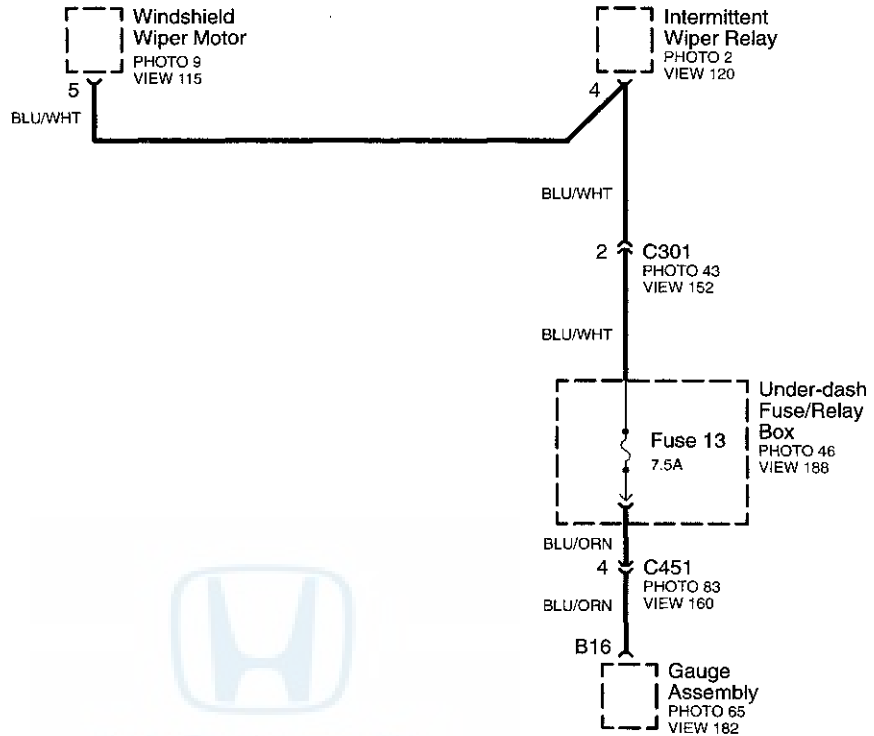

## - Brake Fluid Level

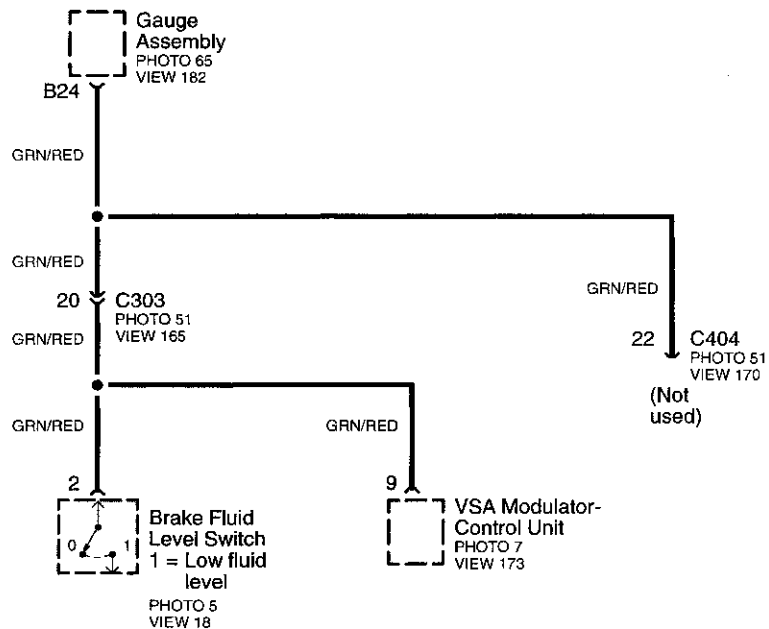



### - F-CAN Communications Line (High)

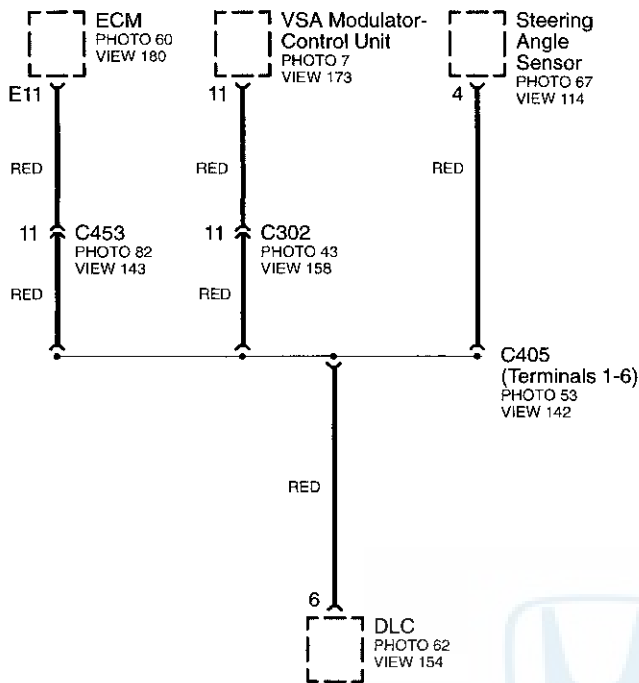

### - F-CAN Communications Line (Low)

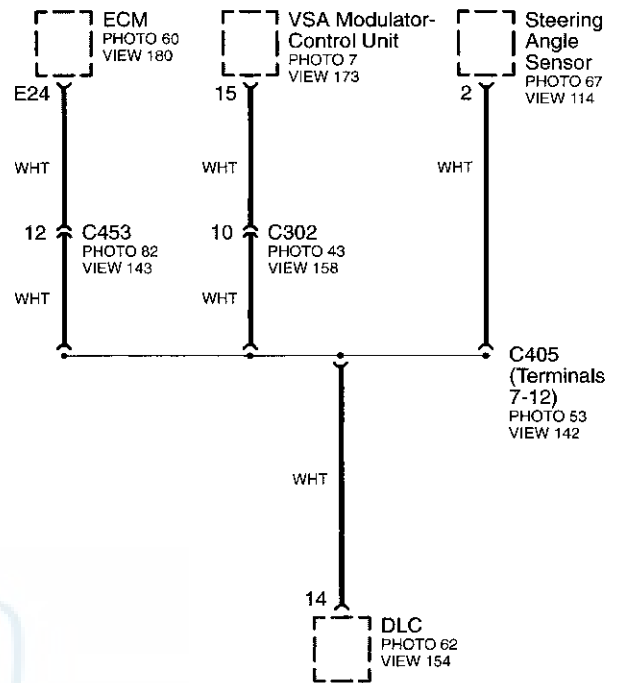

### - PGM-FI Main Relay 1 Control

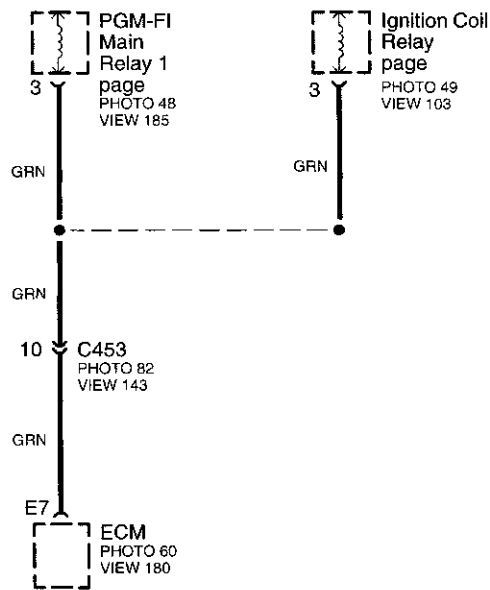





### - Power Source for ECM Sensors -

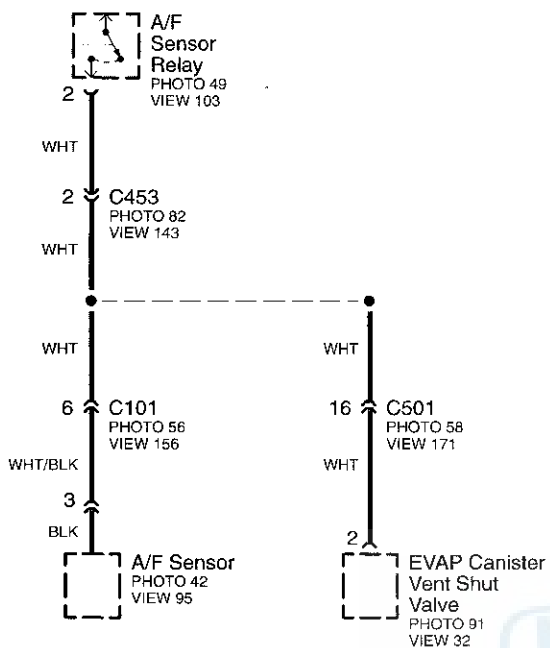

### - Vehicle Speed Sensor Signal 1 -

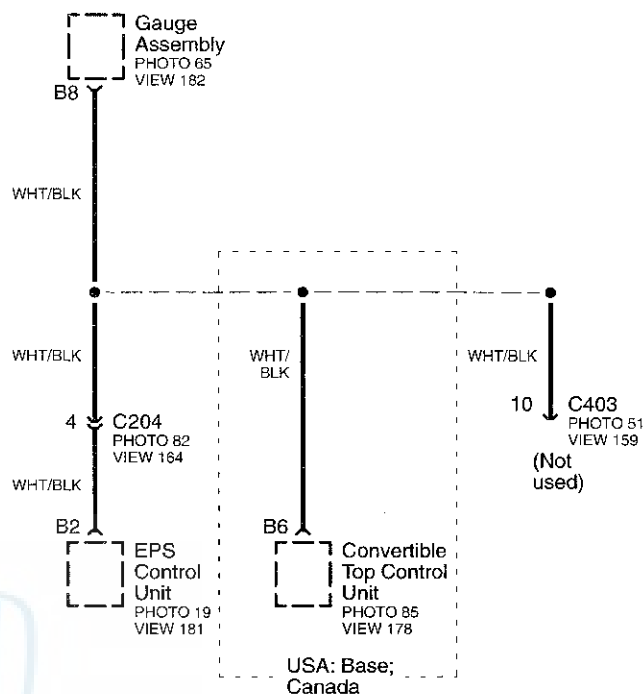

### - Vehicle Speed Sensor Signal 2 -

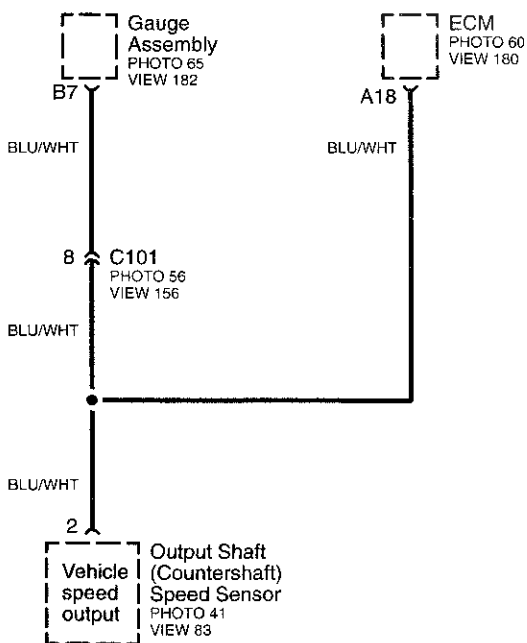

### - Service Check Signal -

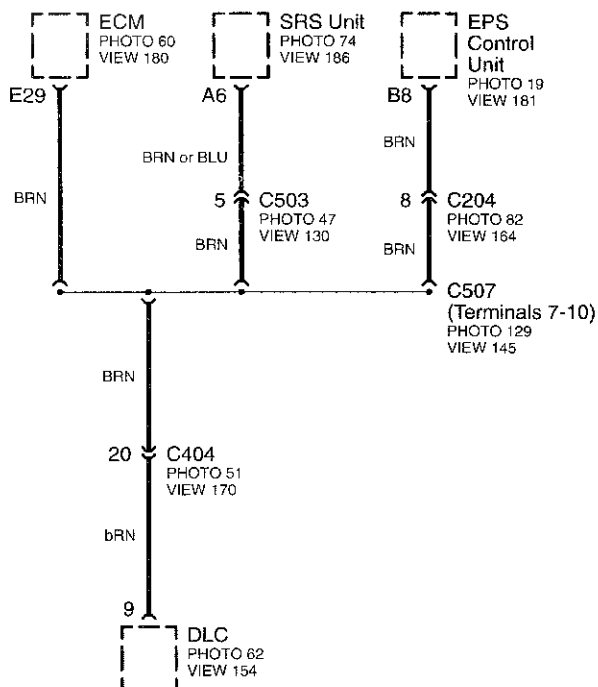

# Splice and Junction Connector Details

## Offboard Diagnosis Signal

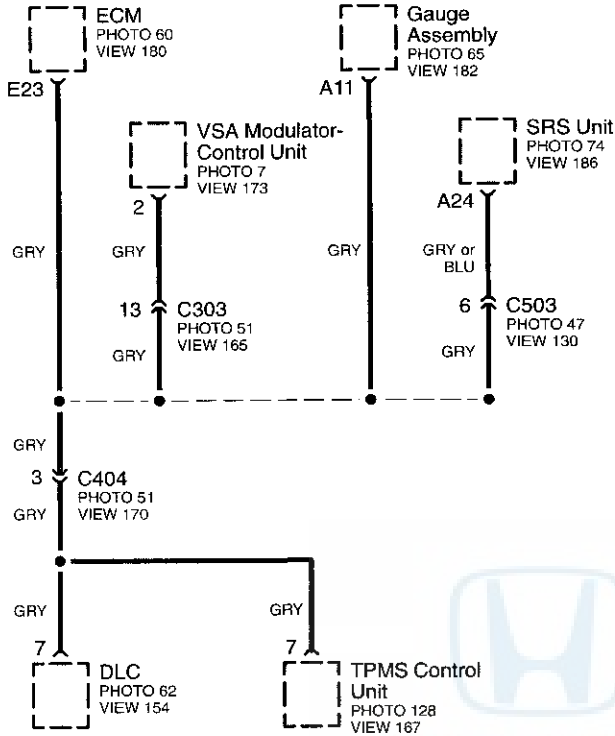

## DLC Input/Output

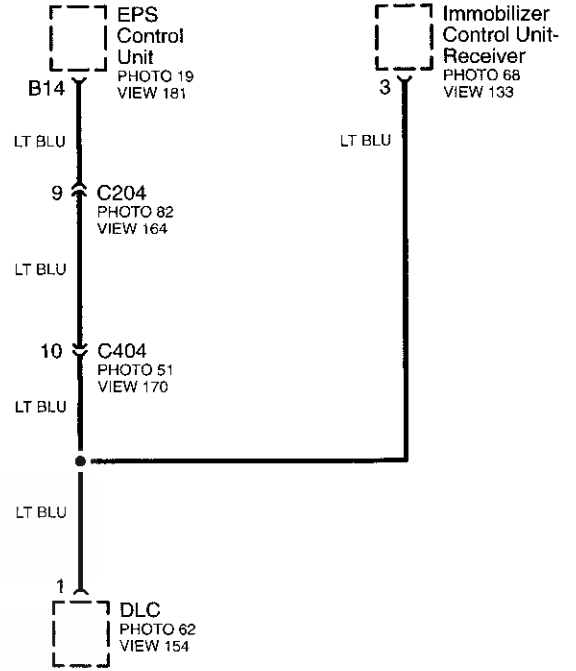

## Engine Start Switch Signal

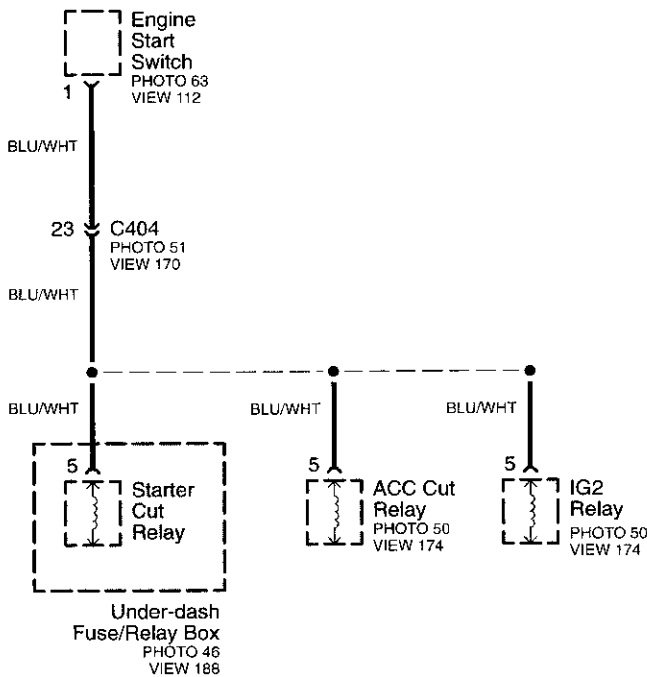

## Clutch Pedal Position

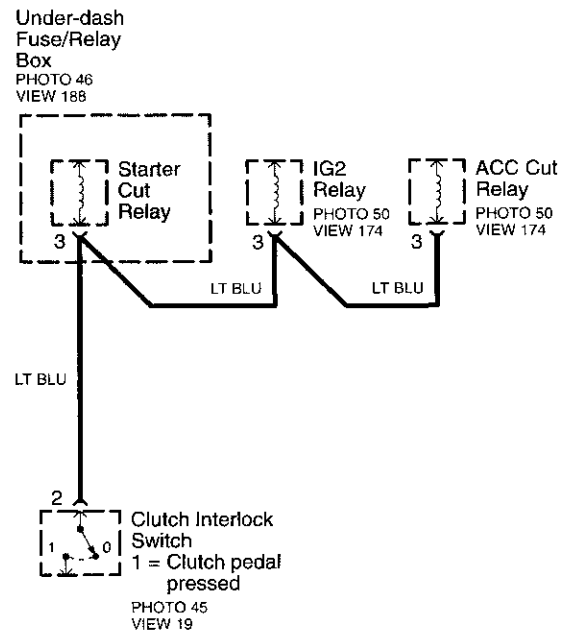



# Splice and Junction Connector Details

## - Ground for ECM Sensors (SG3)

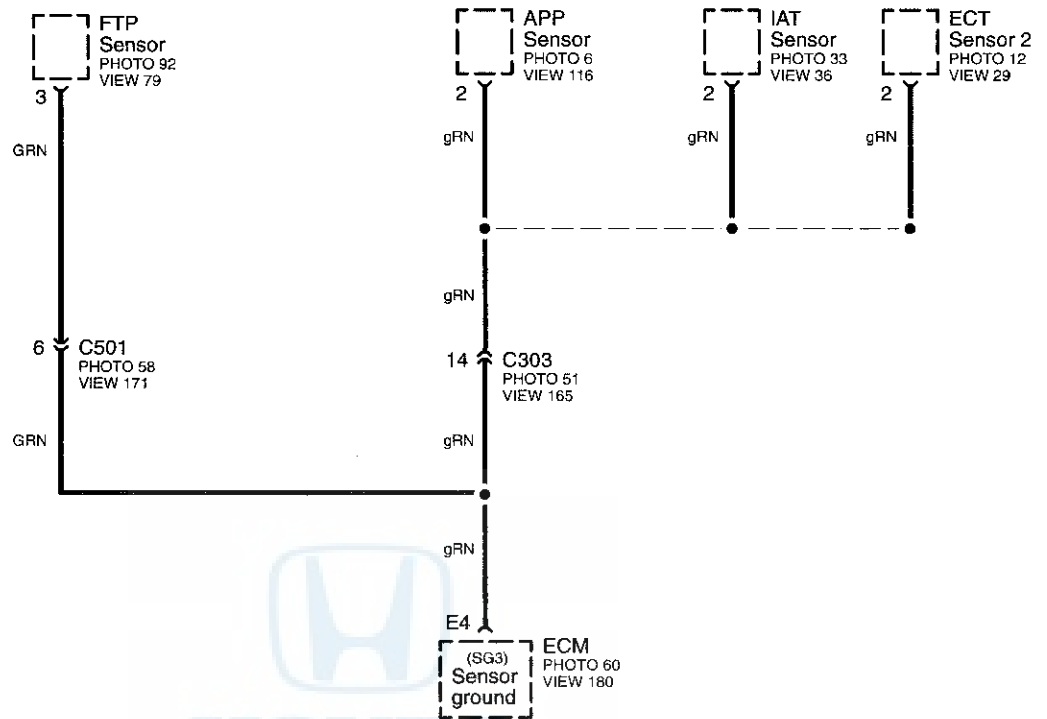





# Ignition System

NOTE: See section 23 for inputs that affect ignition control.

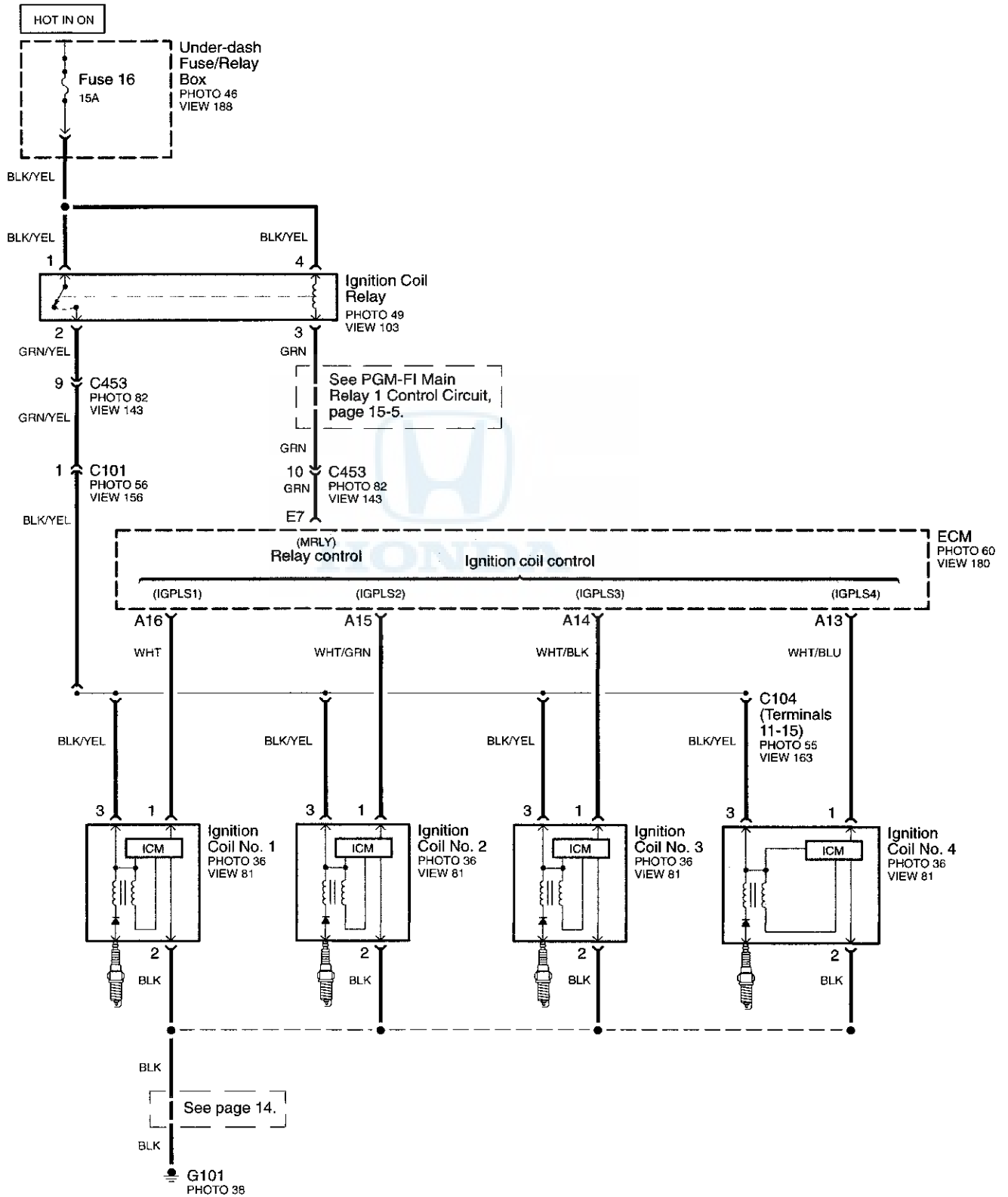



# Starting System

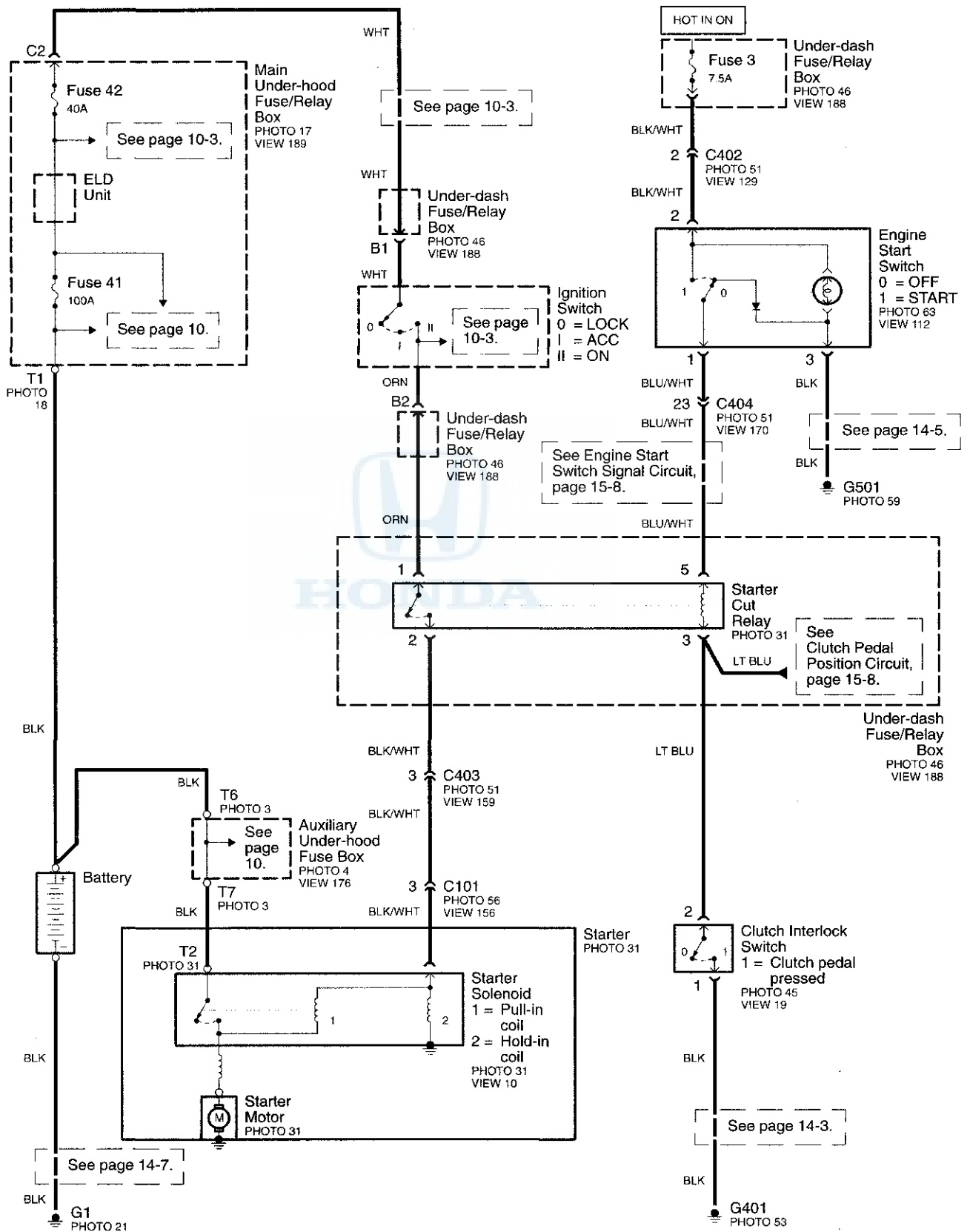







# Fuel and Emissions

## - ECM Power and Ground

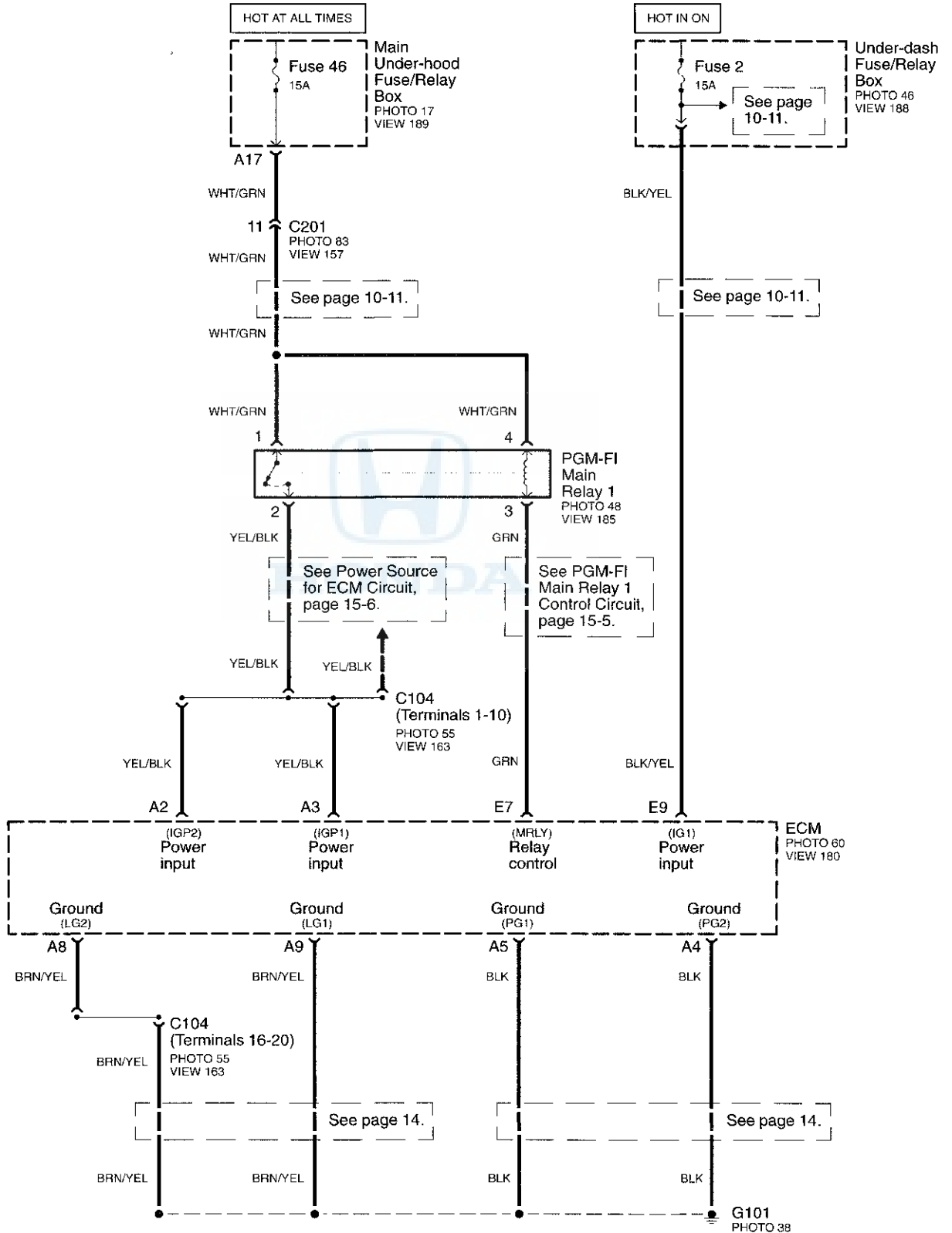





# - DLC and MIL Circuits

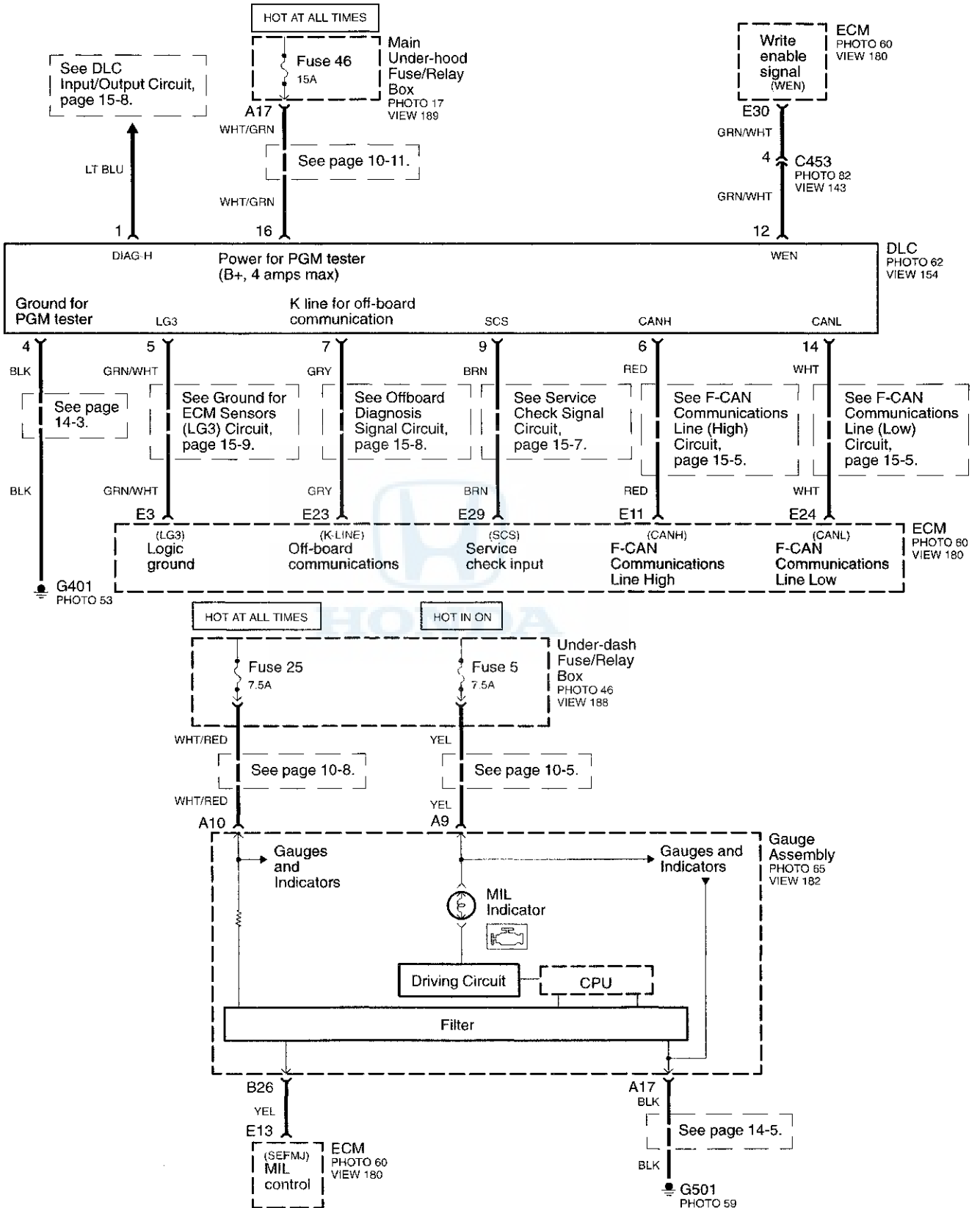

# Fuel and Emissions

## - PGM-FI System

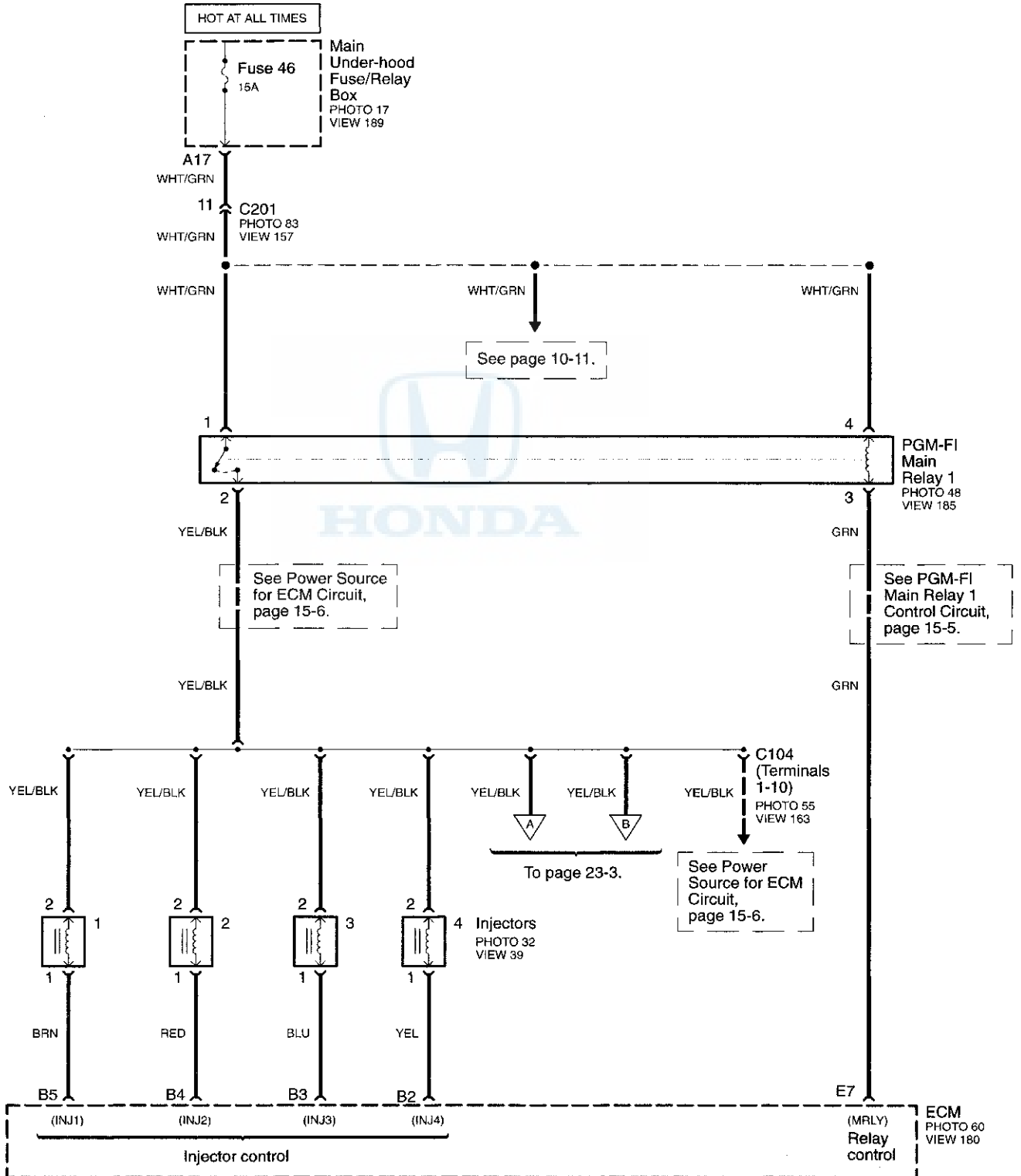

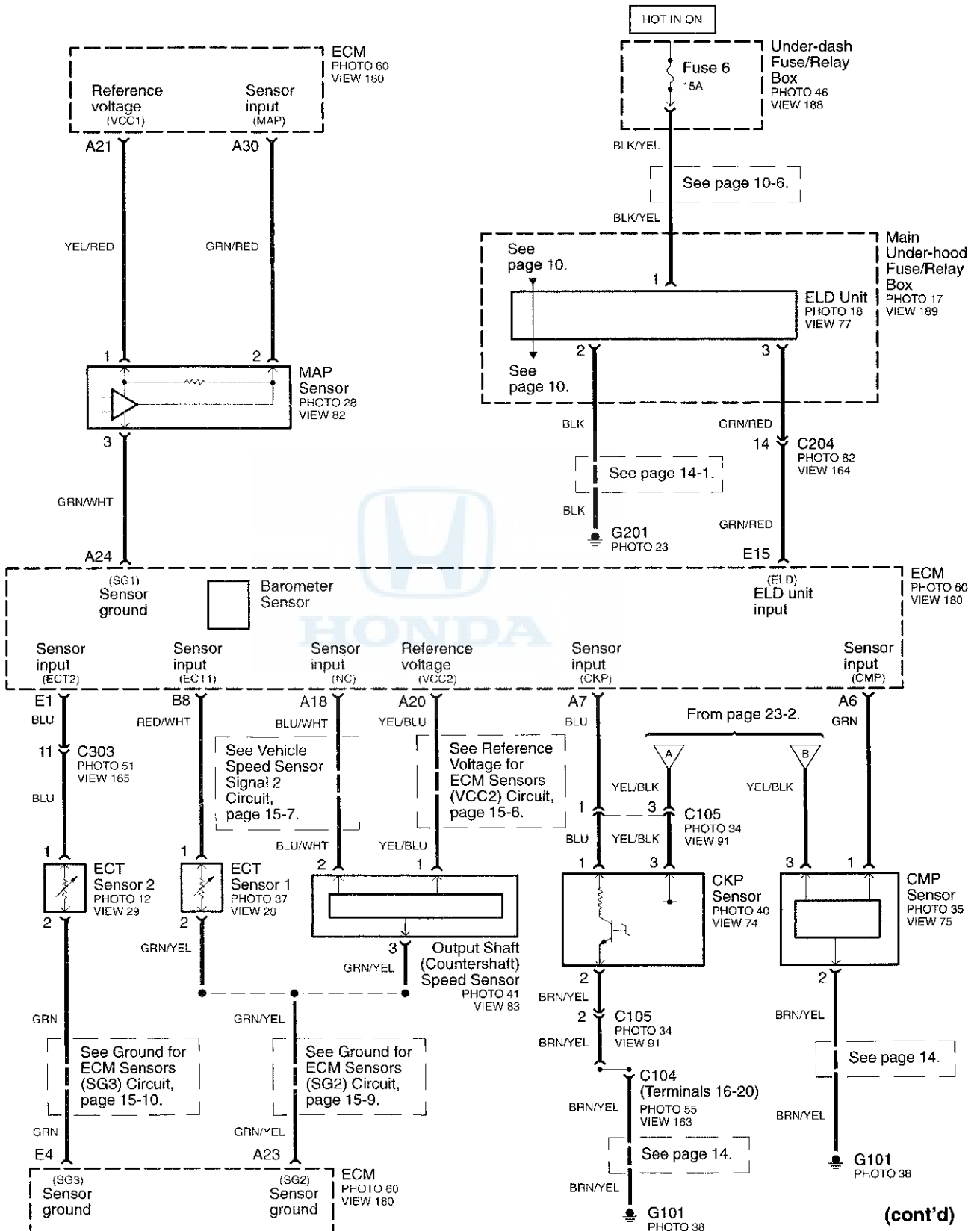

(cont'd)

# Fuel and Emissions

## - PGM-FI System (cont'd)

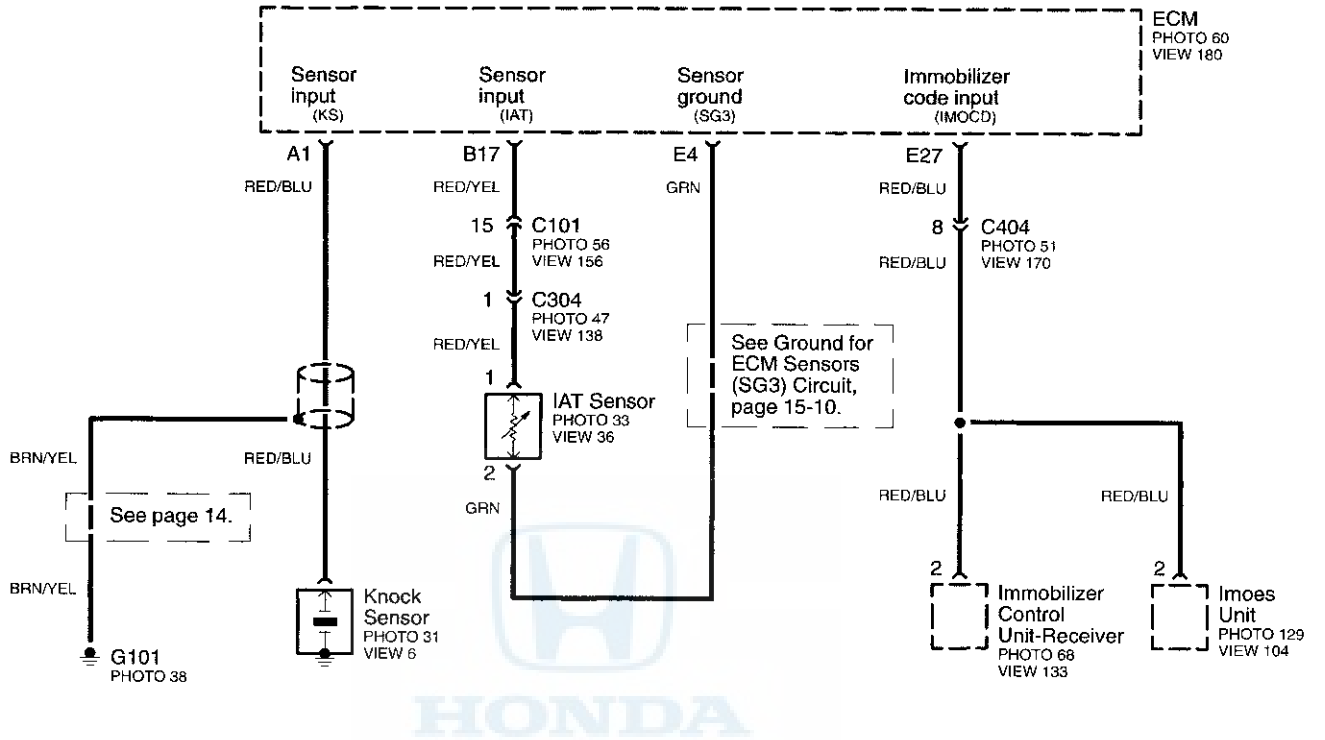



# Fuel and Emissions

## – ETCS (Electronic Throttle Control System)

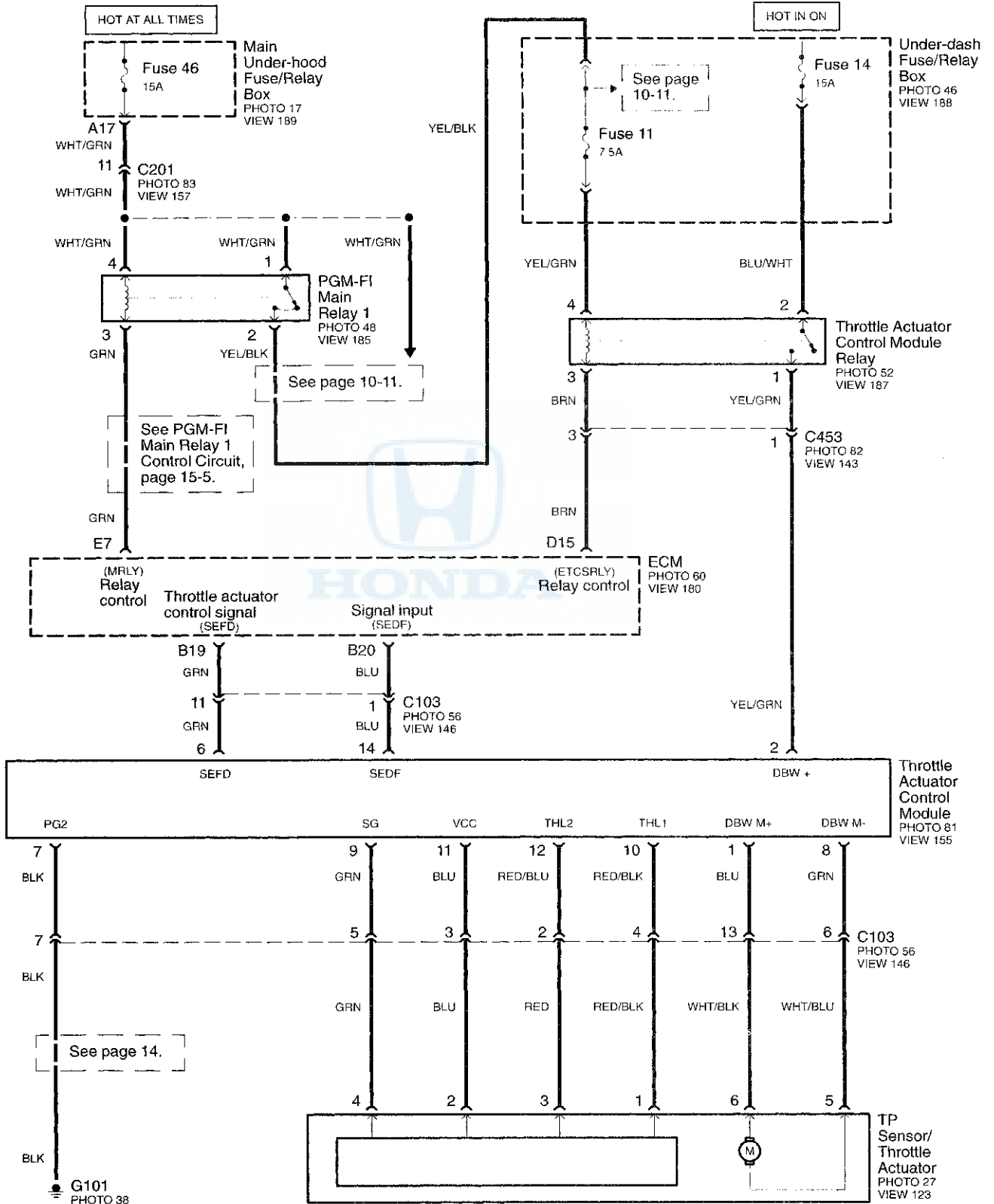

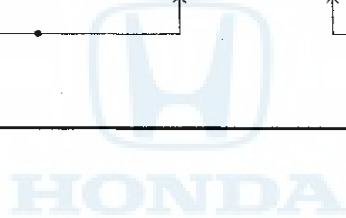
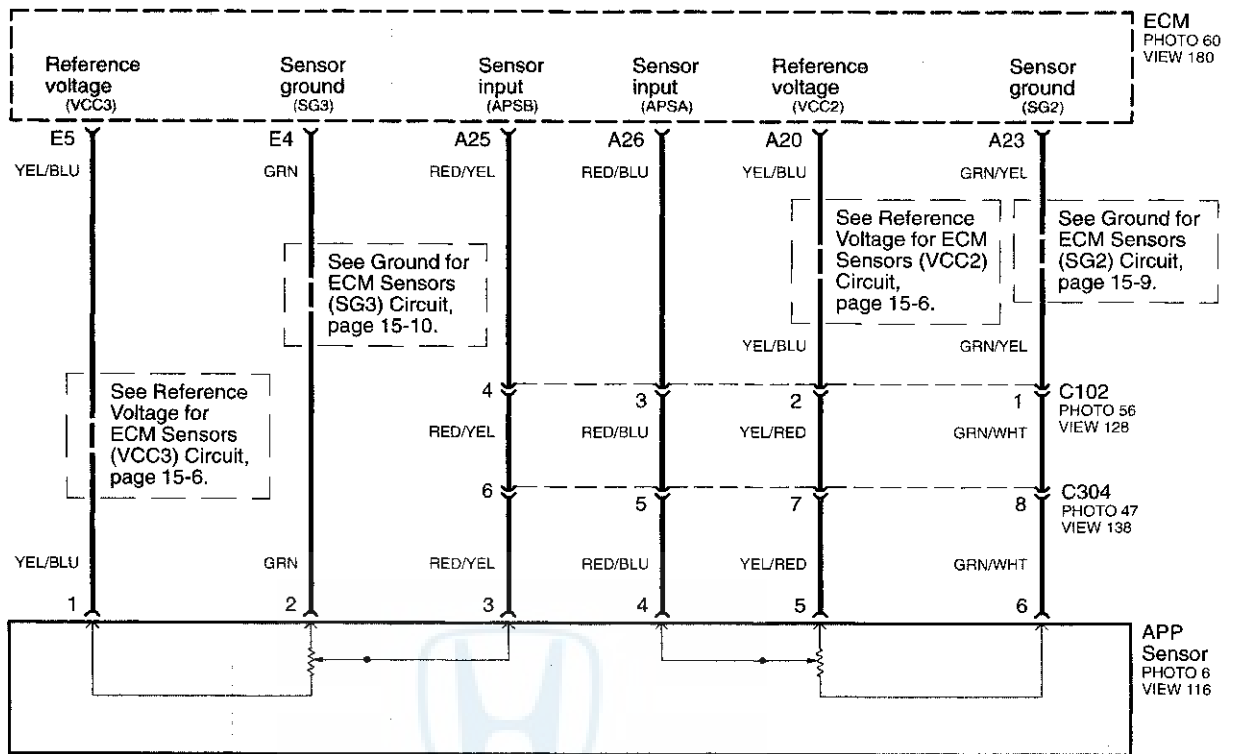

# Fuel and Emissions

## - Idle Control System

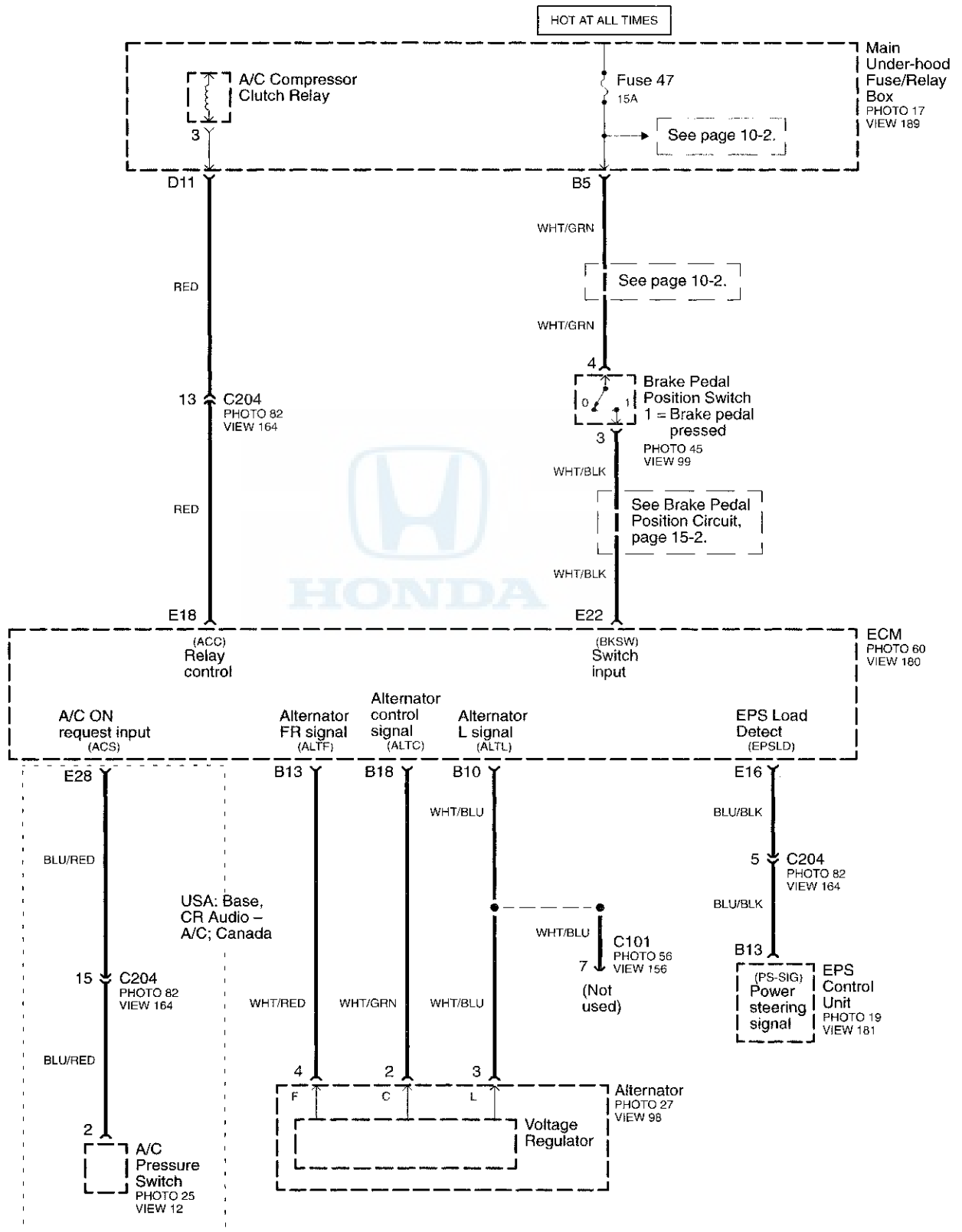



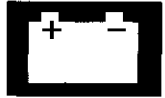

# - Fuel Supply System

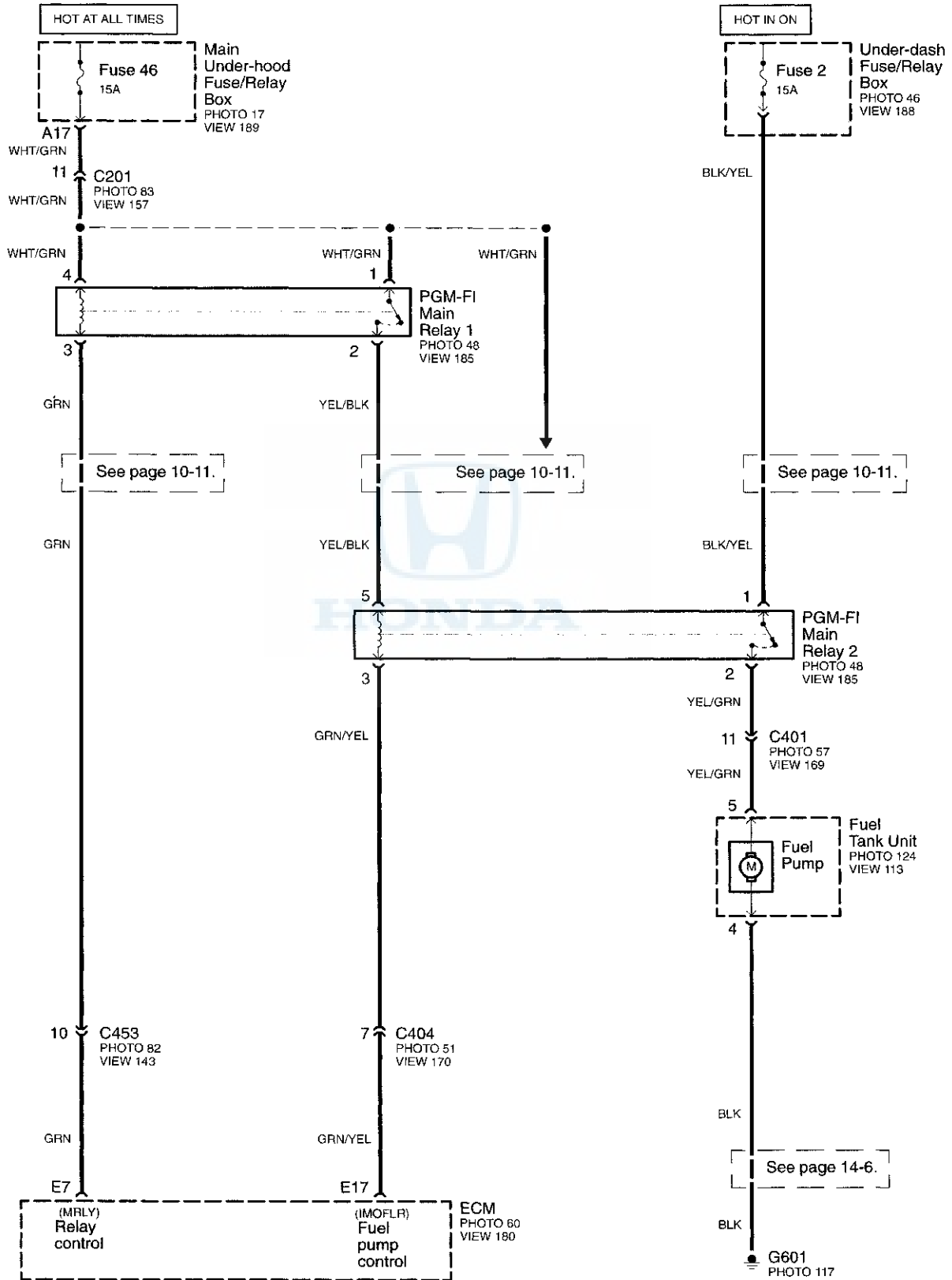

# Fuel and Emissions

## - EVAP System

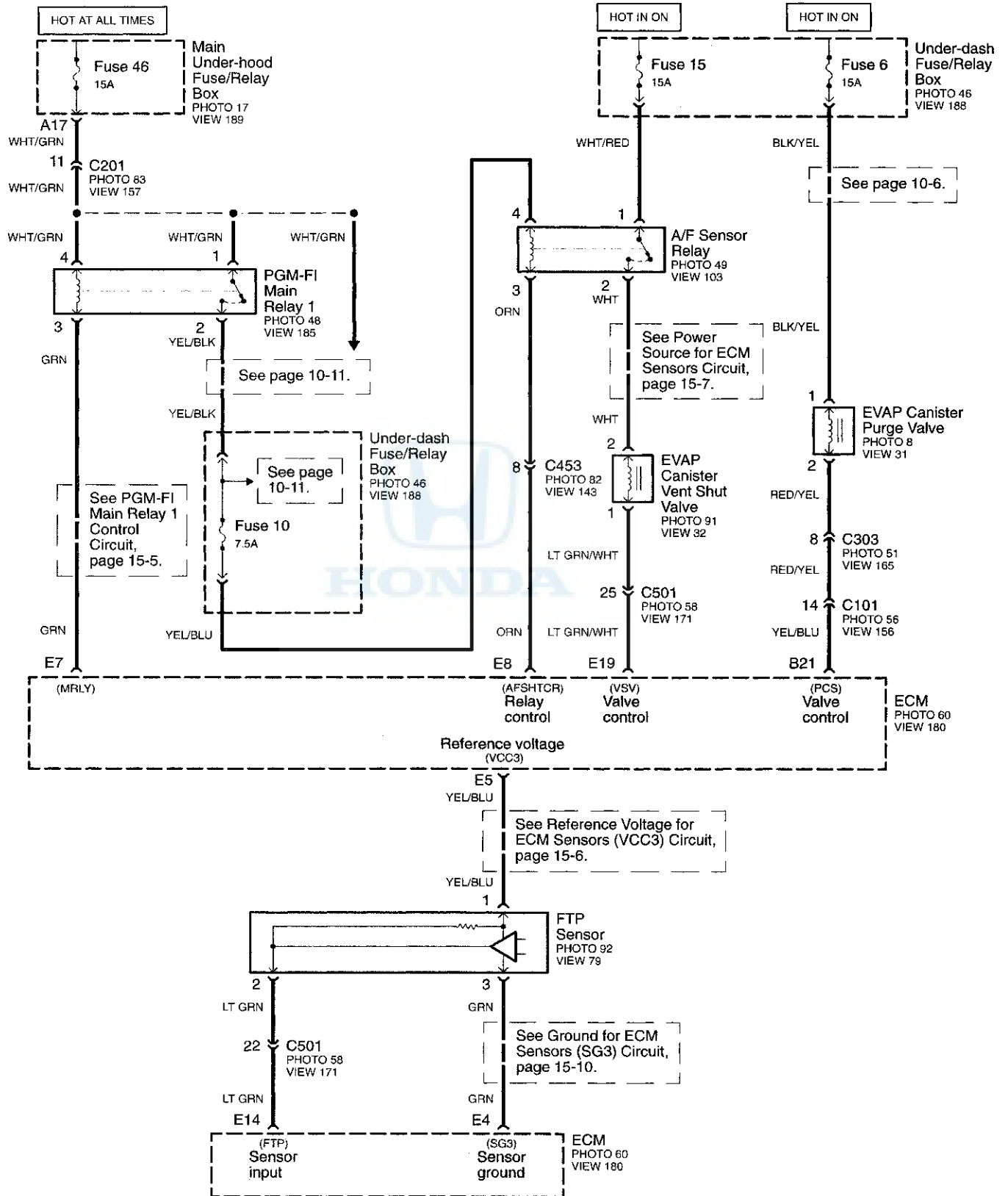



# VTEC System

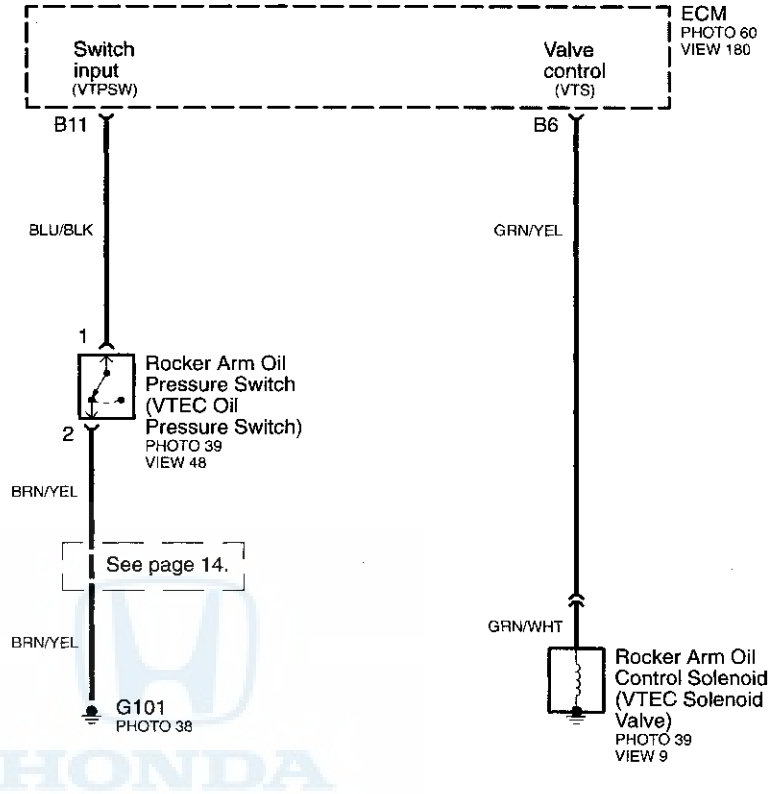





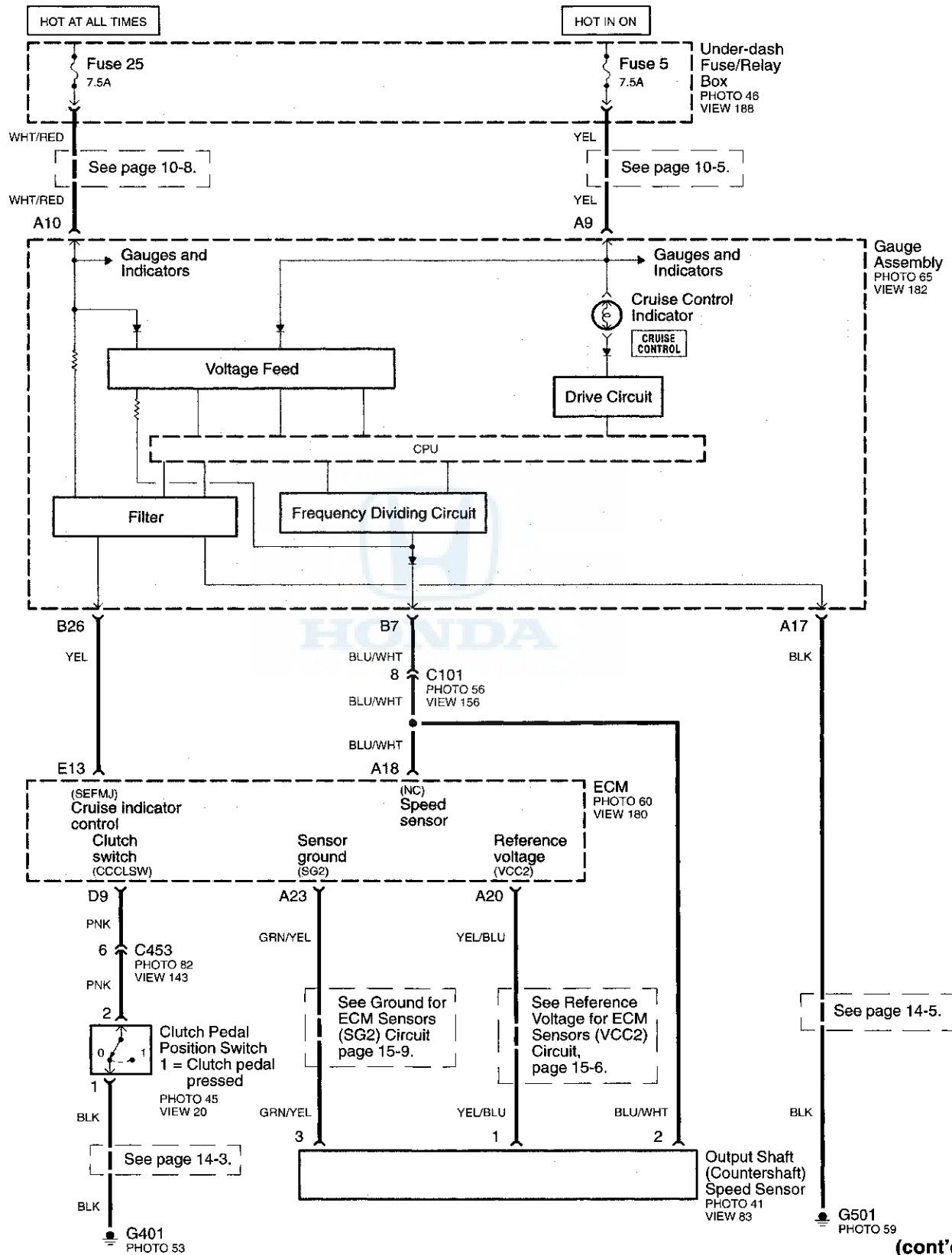

(cont'd)

# Cruise Control

— (cont'd)

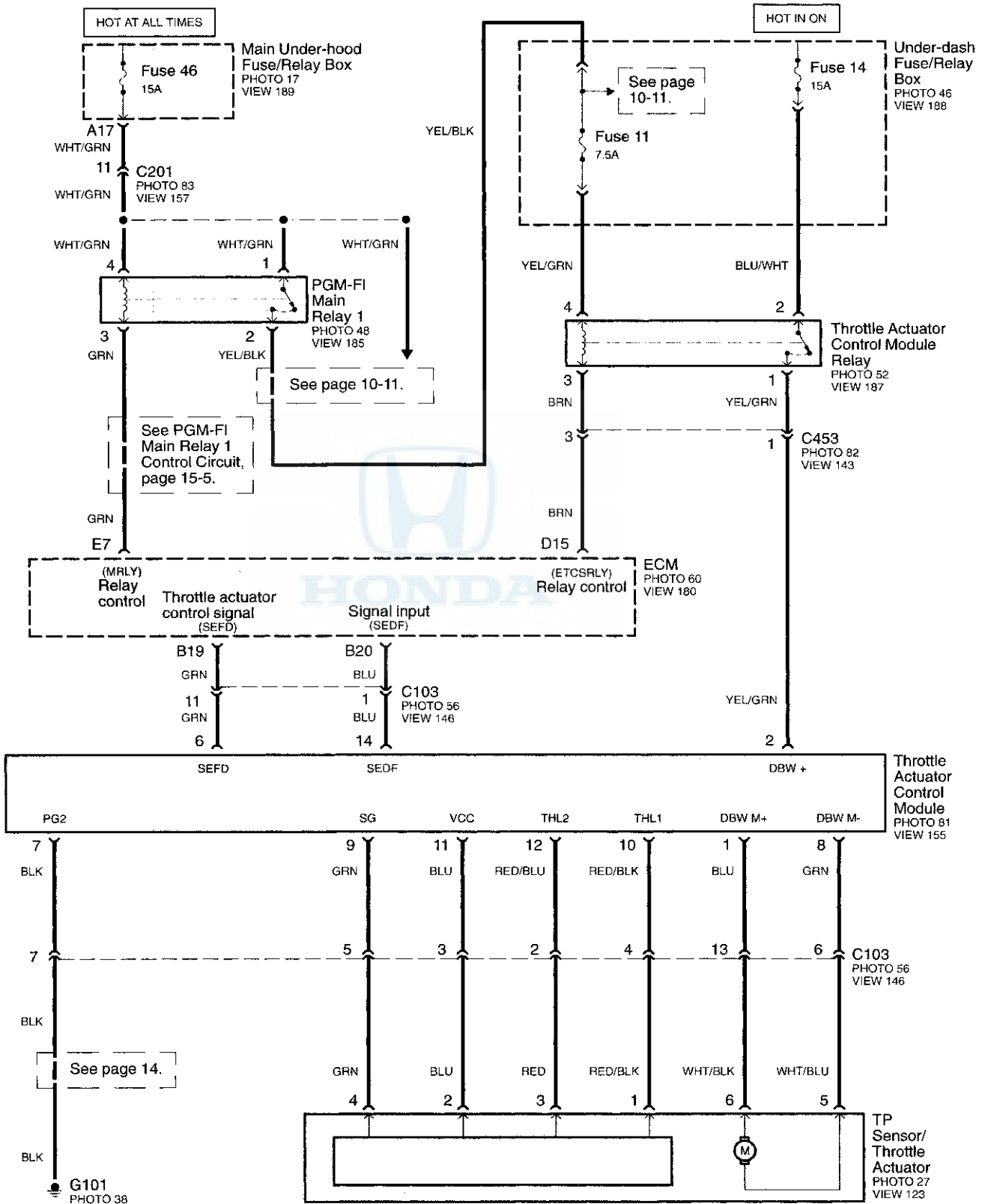



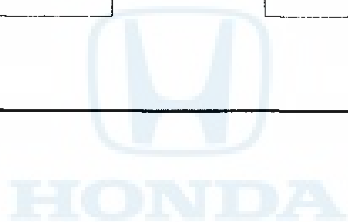
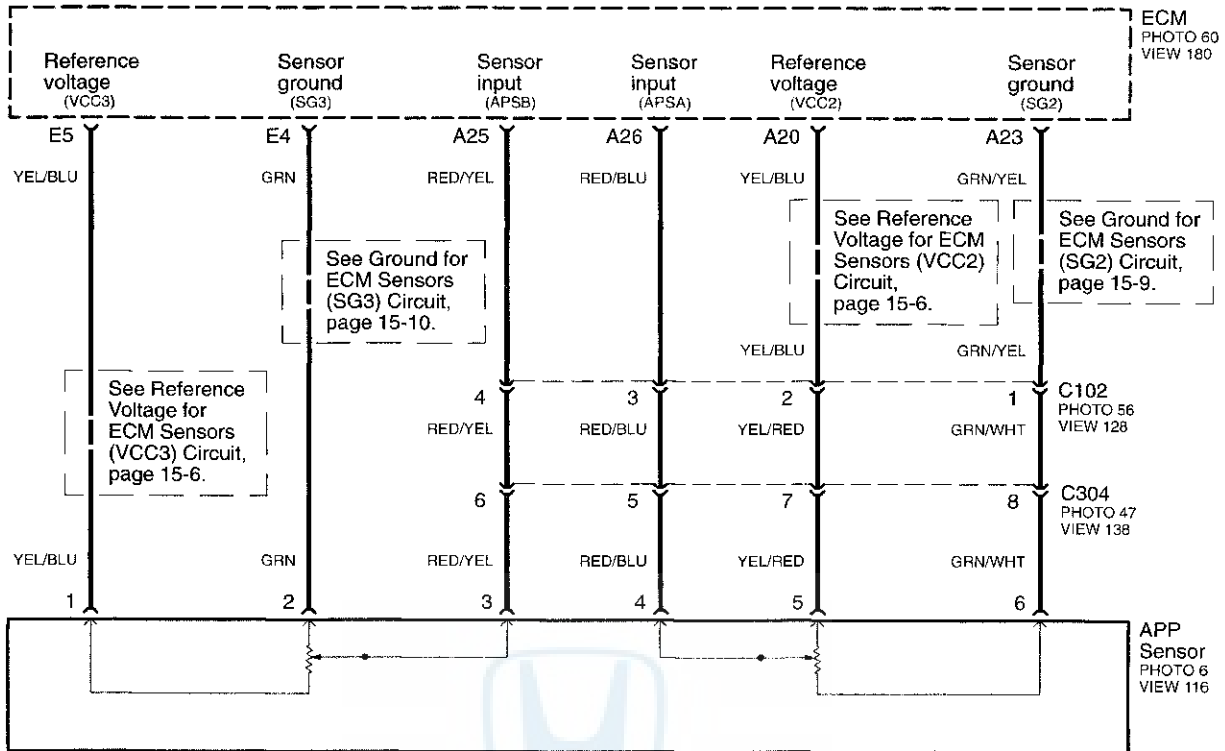

# Cruise Control

## – How the Circuit Works

---

A throttle actuator control motor, located on the side of the throttle housing, is used to open and close the throttle plate for routine driving and cruise conditions.

### Power Supply

With the ignition switch in the ON (II) position, battery voltage is applied through fuse 6 (in the under-dash fuse/relay box) to the cruise control main switch and to the ECM. Battery voltage is also applied through fuses 5 and 25 (in the under-dash fuse/relay box) to the gauge assembly.

Fuse 14 (in the under-dash fuse/relay box) is hot in on and supplies battery voltage to the throttle actuator control module when the throttle actuator module relay is closed.

Fuse 47 (in the main under-hood fuse/relay box) is hot at all times and supplies battery voltage to the ECM when the brake pedal position switch is closed (brake pedal pressed).

### System Description

The gauge assembly receives information signals about operating conditions from the main switch and from the set switch, cancel switch, and the resume switch in the steering wheel.

The control unit compares the actual speed of the vehicle to the selected speed, and then opens or closes the throttle as necessary to match the selected speed.

The brake pedal position switch releases the system's control of the throttle at the instant the brake pedal is pressed. The switch sends a signal to the ECM by applying power to the ECM on one circuit and removing power from the ECM on another circuit. The control unit responds by allowing the throttle to close.

The clutch pedal position switch sends a "disengage" signal that allows the throttle to close (cruise deactivated) when the clutch pedal is pressed.

The throttle actuator control module sends signals to the TP sensor/throttle actuator, which regulates the throttle position to maintain the selected speed. When you push the DECEL/SET switch to set the cruise, the CRUISE CONTROL indicator on the gauge assembly lights up. You can cancel the cruise control system by pushing the cancel switch

or by turning the main switch off.

If the system is disengaged temporarily by the brake pedal position switch or the clutch pedal position switch, and the vehicle's speed is still above 25 mph (40 KmH), pressing the RES/ACCEL switch will return the vehicle to the previously set speed automatically.

For gradual acceleration without pressing the accelerator pedal, push the RES/ACCEL switch and hold it. To increase the speed in very small amounts, tap the RES/ACCEL switch one time for each one mph (KmH) of increase.

To slow the vehicle, push the DECEL/SET switch in and hold it. To decrease the speed in very small amounts, tap the RES/ACCEL switch one time for each one mph (KmH) of decrease.

Refer to the Service Manual (Section 4, Engine Electrical) for specific tests or troubleshooting procedures.





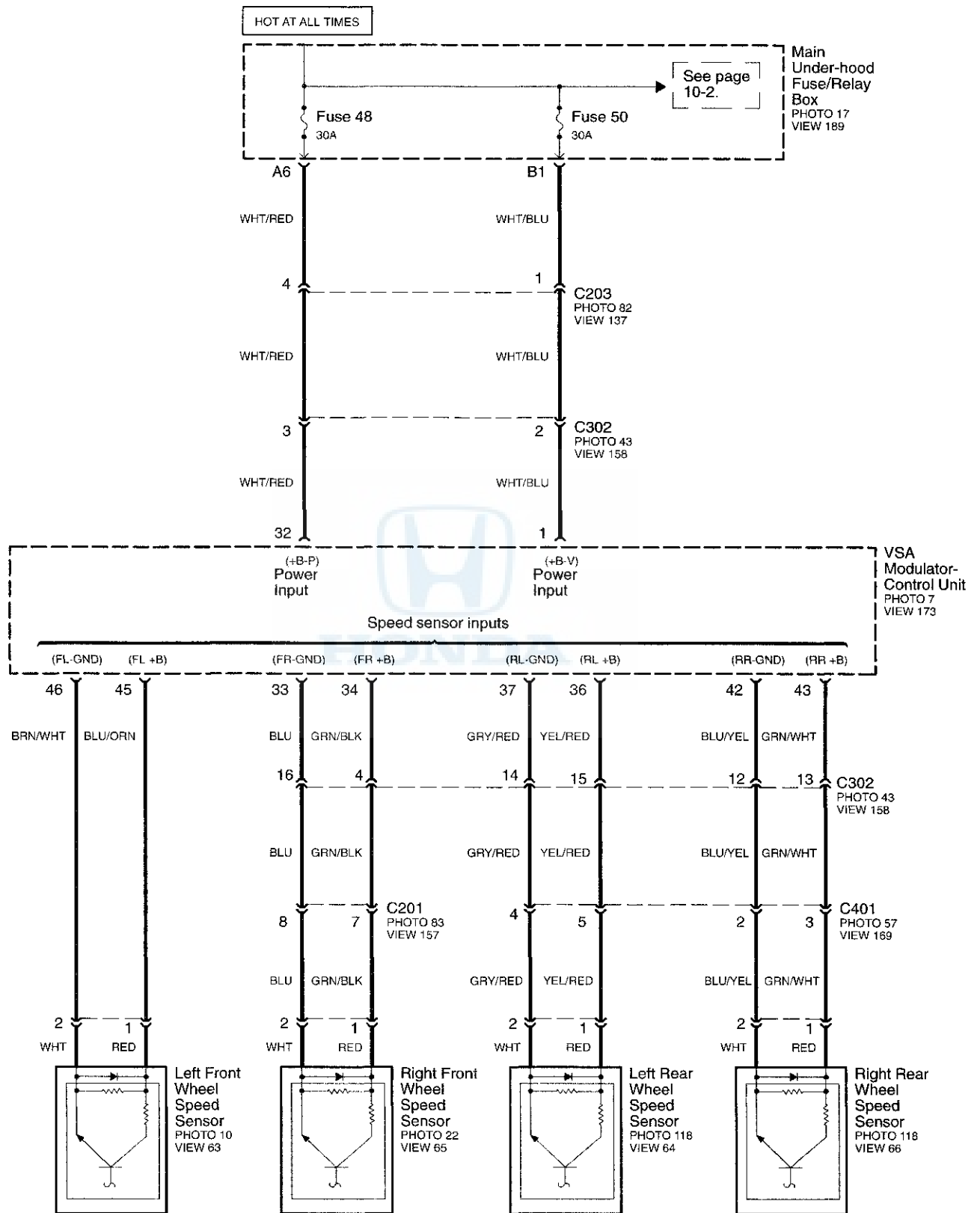

(cont'd)





# Horns

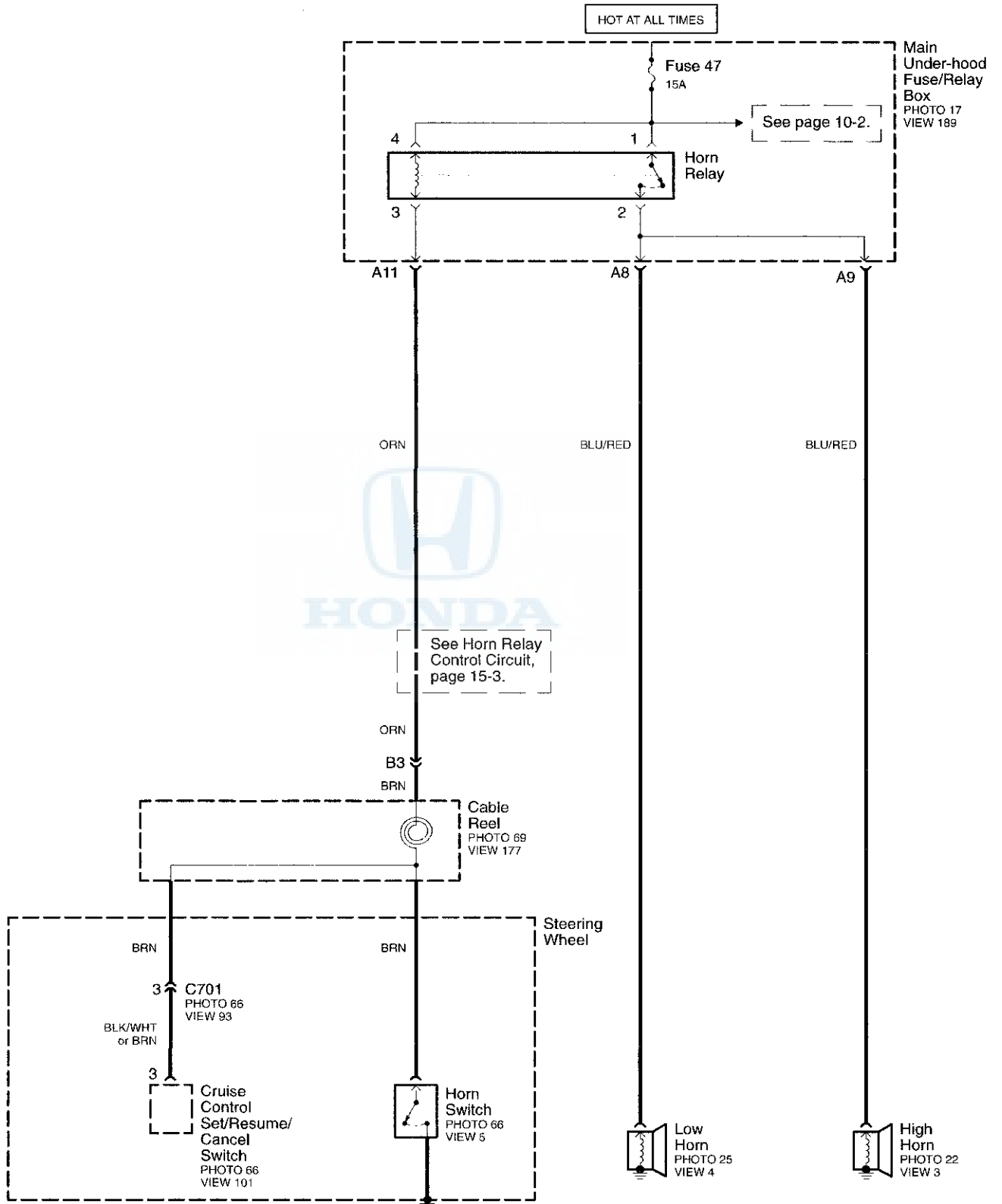







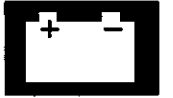

# SRS

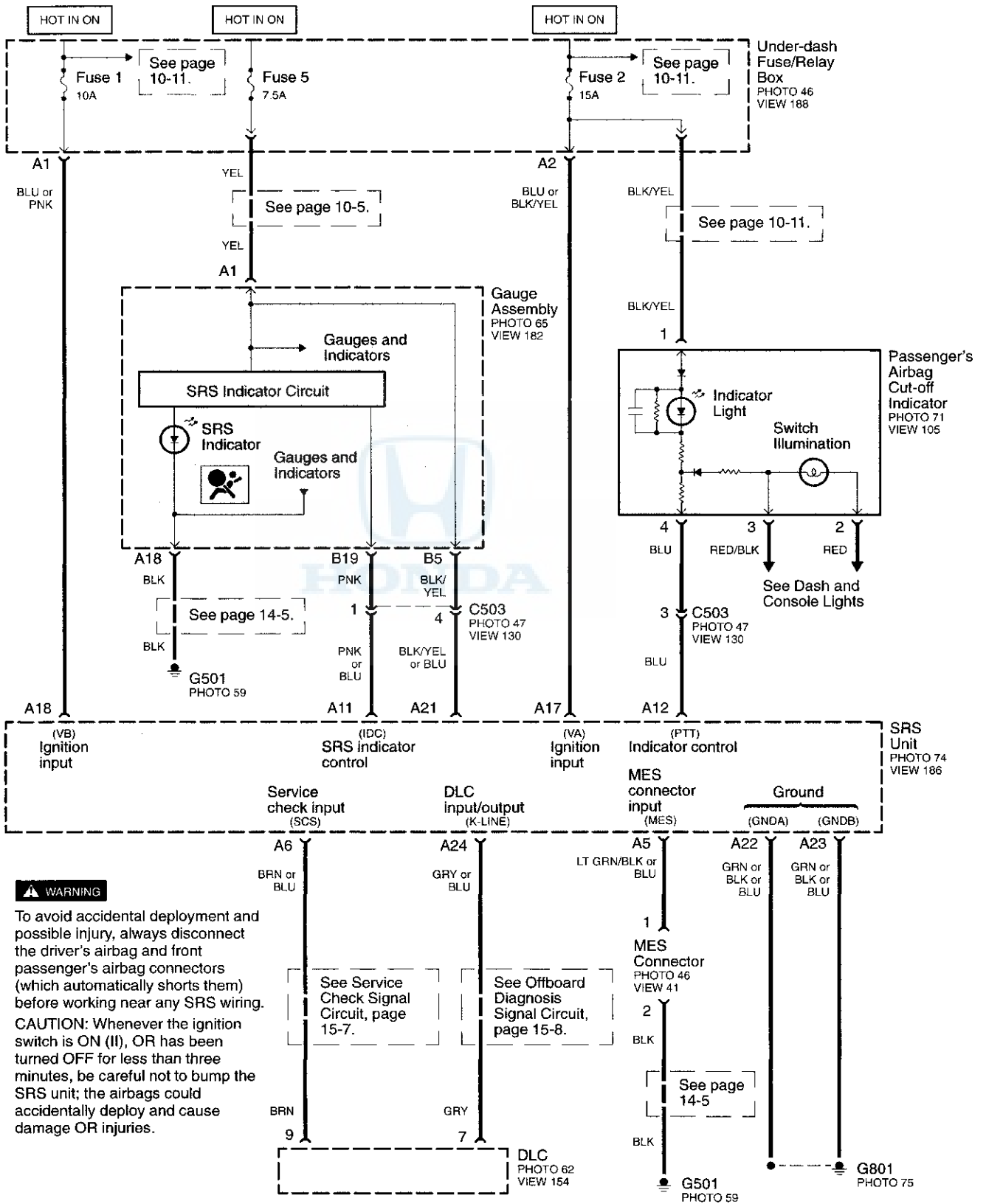

**⚠ WARNING**

To avoid accidental deployment and possible injury, always disconnect the driver's airbag and front passenger's airbag connectors (which automatically shorts them) before working near any SRS wiring.

**CAUTION:** Whenever the ignition switch is ON (II), OR has been turned OFF for less than three minutes, be careful not to bump the SRS unit; the airbags could accidentally deploy and cause damage OR injuries.

See Service Check Signal Circuit, page 15-7.

See Offboard Diagnosis Signal Circuit, page 15-8.

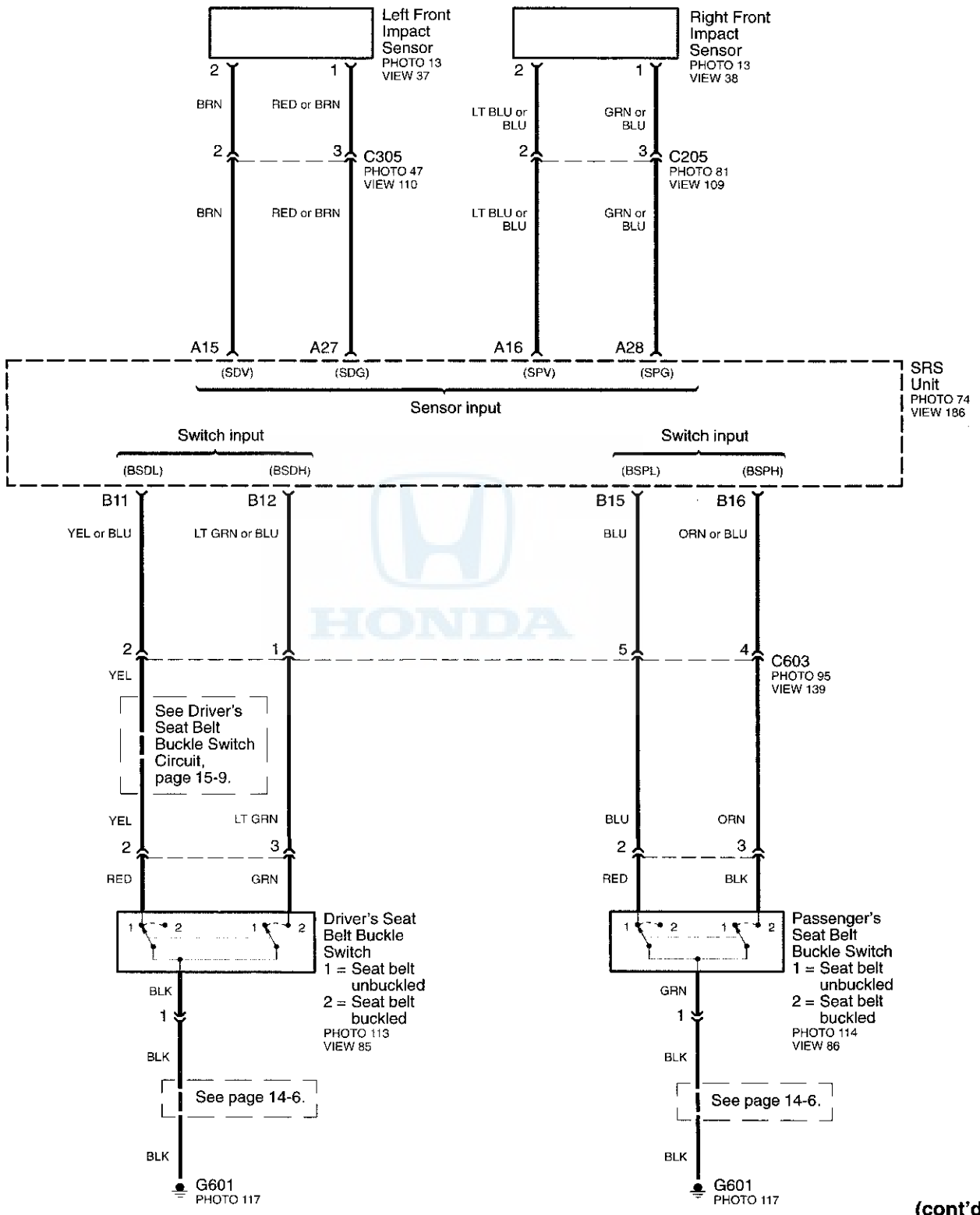

(cont'd)

# SRS

– (cont'd)

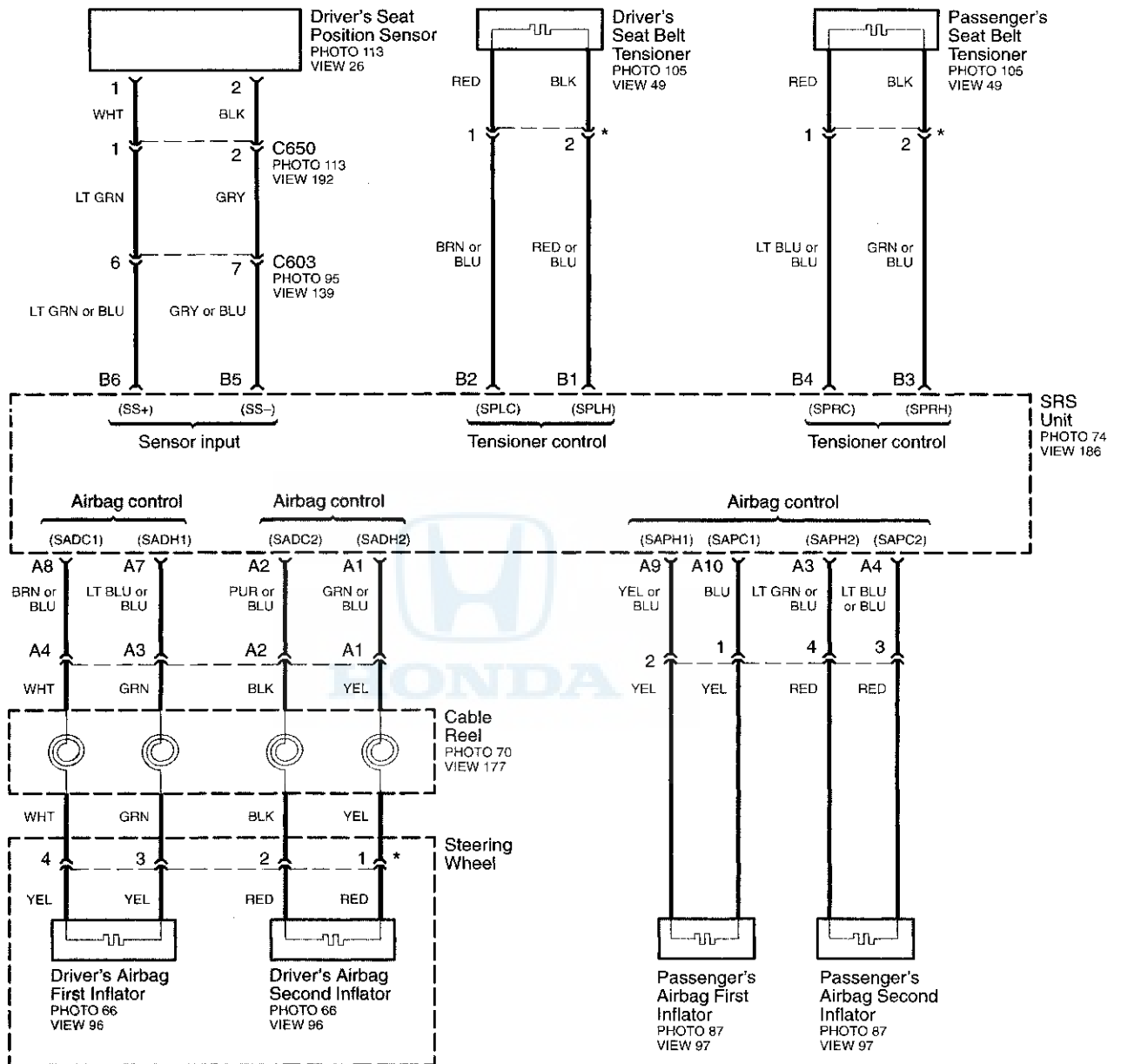

\* = Has built-in short contact.

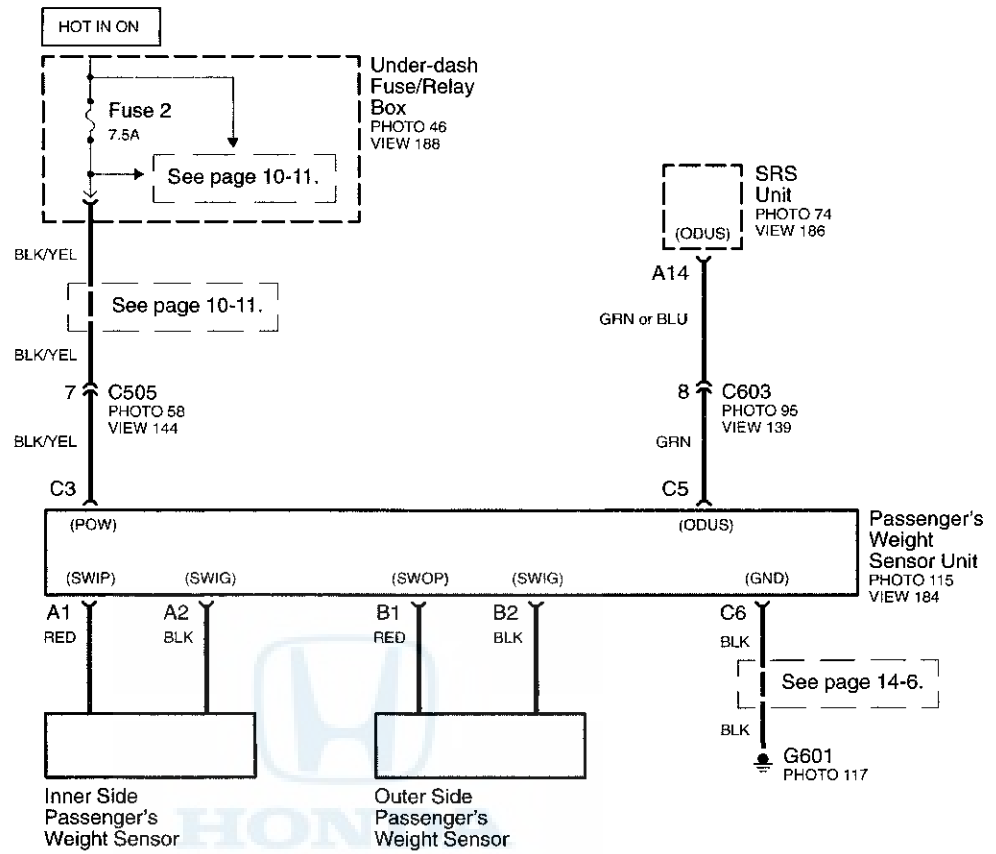

# HVAC

NOTE: See page 10-4 for details of Fuse 20.

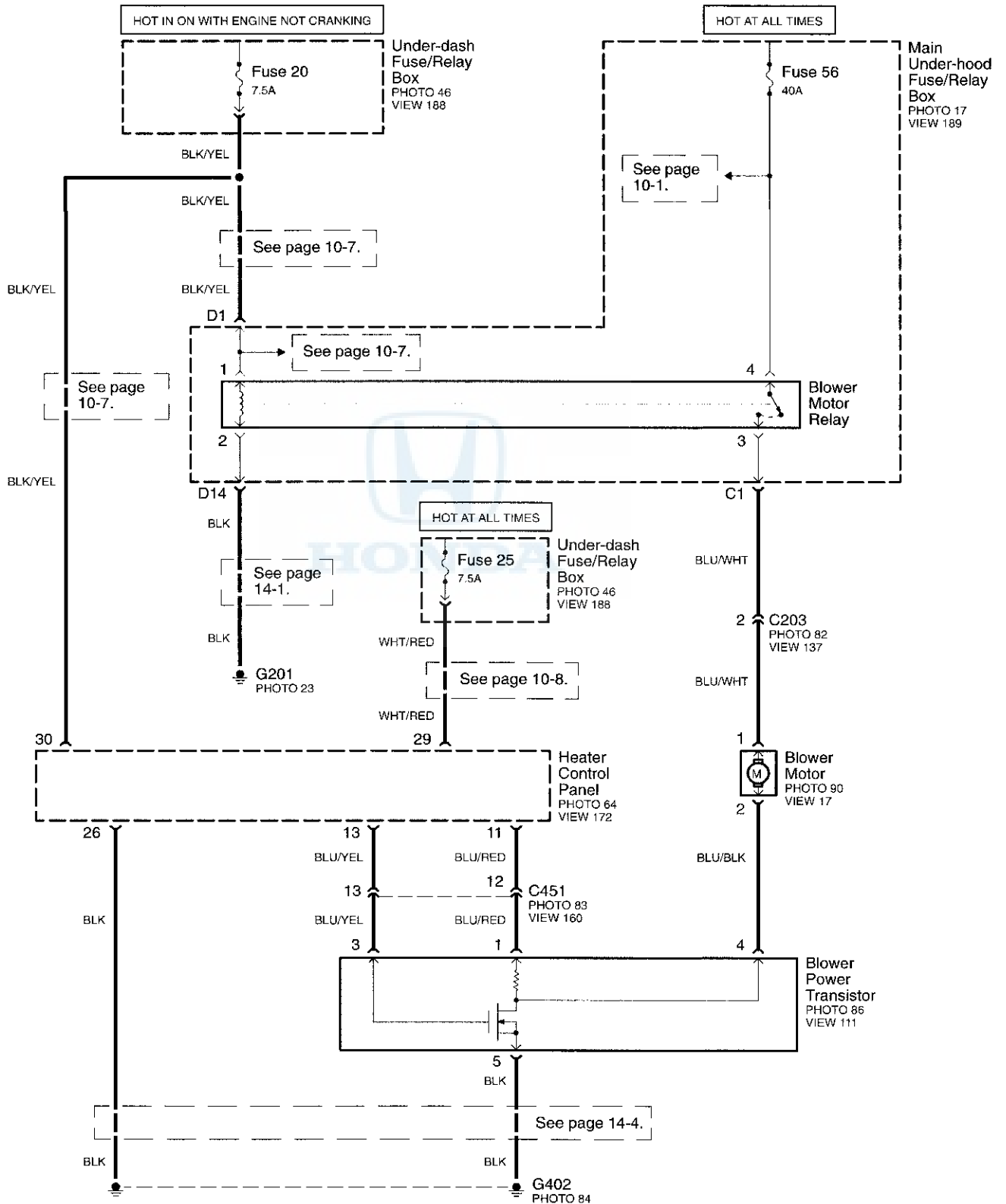





NOTE: See page 10-4 for details of Fuse 20.

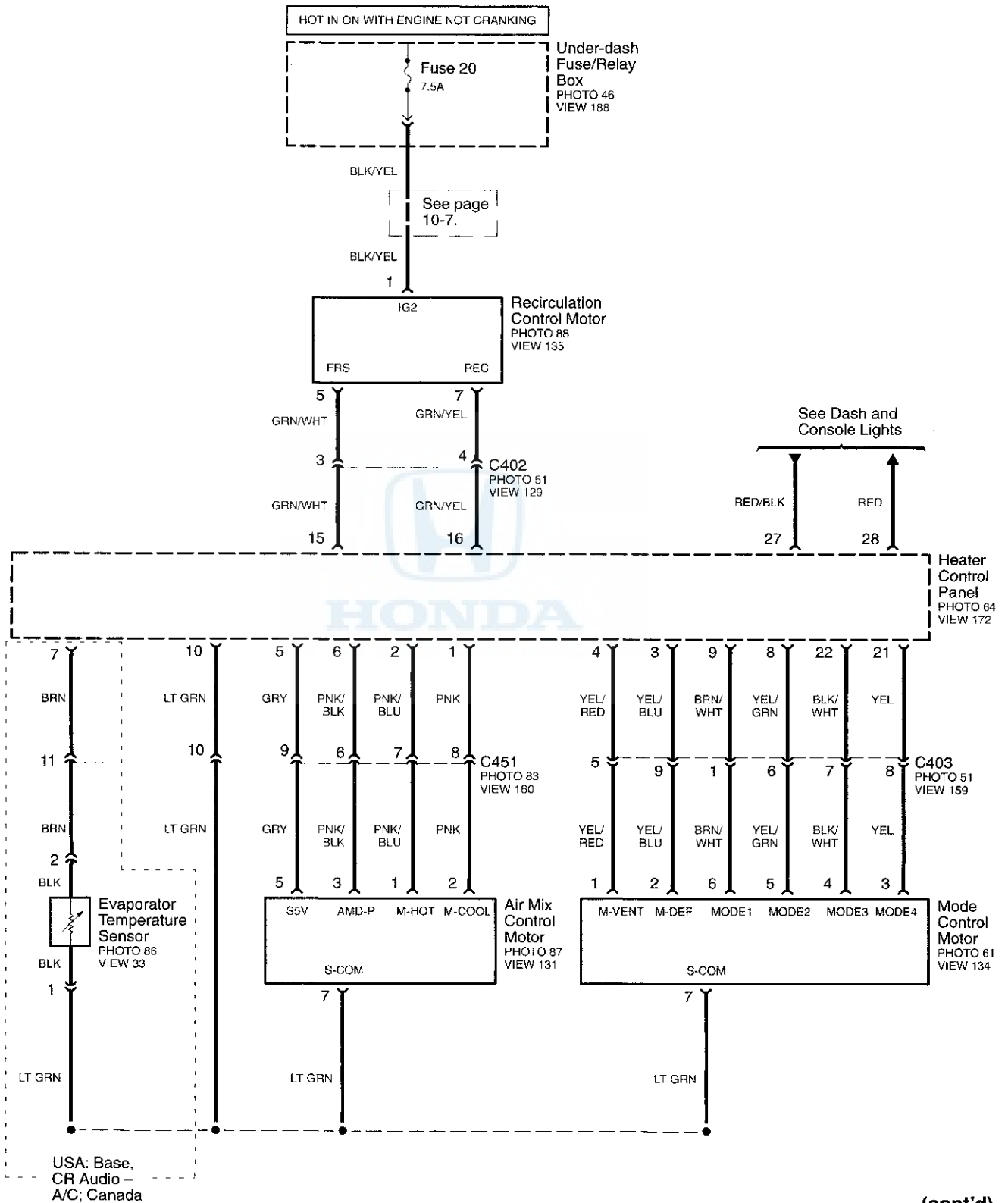

(cont'd)





## – How the Circuit Works

### Blower Controls

The blower motor is controlled by the heater control panel, which receives battery voltage at all times through fuse 25 (in the under-dash fuse/relay box). With the ignition switch ON (II) and the engine not cranking, battery voltage is supplied to the control panel through fuse 20 (in the under-dash fuse/relay box). The control panel is grounded at G402.

Battery voltage is applied through fuse 56 (in the main under-hood fuse/relay box) to the blower motor relay contacts at all times. With the ignition switch ON (II) and the engine not cranking, the blower motor relay in the main under-hood fuse/relay box is energized, which feeds battery voltage to the blower motor. The blower power transistor controls the blower motor in all speeds except HIGH. The blower power transistor is controlled by the heater control panel. When the control panel requests HIGH blower speed, it grounds the blower motor through a resistor built-into the blower power transistor, making the blower run at high speed.

### Air Delivery

The heater control panel receives battery voltage at all times through fuse 25 (in the under-dash fuse/relay box). With the ignition switch ON (II), and the engine not cranking, voltage is supplied to the control panel through fuse 20 (in the under-dash fuse/relay box). The control panel, which is grounded at G402, controls the blower motor and supplies a 5 VDC reference voltage to the air mix control motor.

The air mix and mode control motors each receive inputs from the control panel. The air mix motor regulates the mixture of cold and hot air by varying the position of the heater-evaporator door. The mode control motor controls the direction and volume of outlet air. The air flow can be directed to the dashboard vents or the corner vent on the passenger's side. The air mix control motor and mode control motor are grounded by the control panel.

The recirculation control motor receives battery voltage through fuse 20 (in the under-dash fuse/relay box) when the ignition switch is ON (II), and the engine is not cranking. It regulates the position of the fresh/recirc door, and is controlled by two position inputs from the control panel ("RECIRC" and "FRESH").

### A/C Compressor Controls

Voltage is provided at all times to the heater control panel through fuse 25 (in the under-dash fuse/relay box), and to the A/C compressor clutch relay contacts through fuse 58 (in the main under-hood fuse/relay box). With the ignition switch ON (II) and the engine not cranking, voltage is supplied to the control panel and the relay coil through fuse 20 (in the under-dash fuse/relay box). The control panel is grounded at G402.

When you push the A/C button ON with the ignition switch ON (II) and the heater fan switch not in the OFF position, the control panel will ground the A/C ON request from input of the ECM through the A/C pressure switch. The ECM then grounds the A/C compressor clutch relay coil. This energizes the coil, which closes the relay contacts and provides voltage through fuse 58 (in the main under-hood fuse/relay box) to the A/C compressor clutch. The clutch then engages and begins turning the compressor.

### Evaporator Temperature Sensor

The evaporator temperature sensor is located on the evaporator housing. If the temperature at the evaporator gets too cold, the evaporator temperature sensor sends a signal to the heater control panel to turn off the A/C compressor clutch. This prevents condensation from freezing on the evaporator fins and blocking air delivery into the passenger compartment.

### A/C Pressure Switch

The A/C pressure switch is located in the condenser outlet line where refrigerant is in a high temperature/high pressure liquid state. The switch will sense abnormally high or low pressure, and open the circuit. This removes the ground signal from the ECM, disengaging the compressor clutch.

### Thermal Protector

If the thermal protector, located on the A/C compressor, senses high temperature in the compressor, its switch will open, turning the compressor off. Once the compressor cools, the switch will close and the compressor will begin running again.

Refer to the Service Manual (Section 21, HVAC) for specific tests and troubleshooting procedures.

# Fans

Note: See page 10-4 for details of Fuse 20.

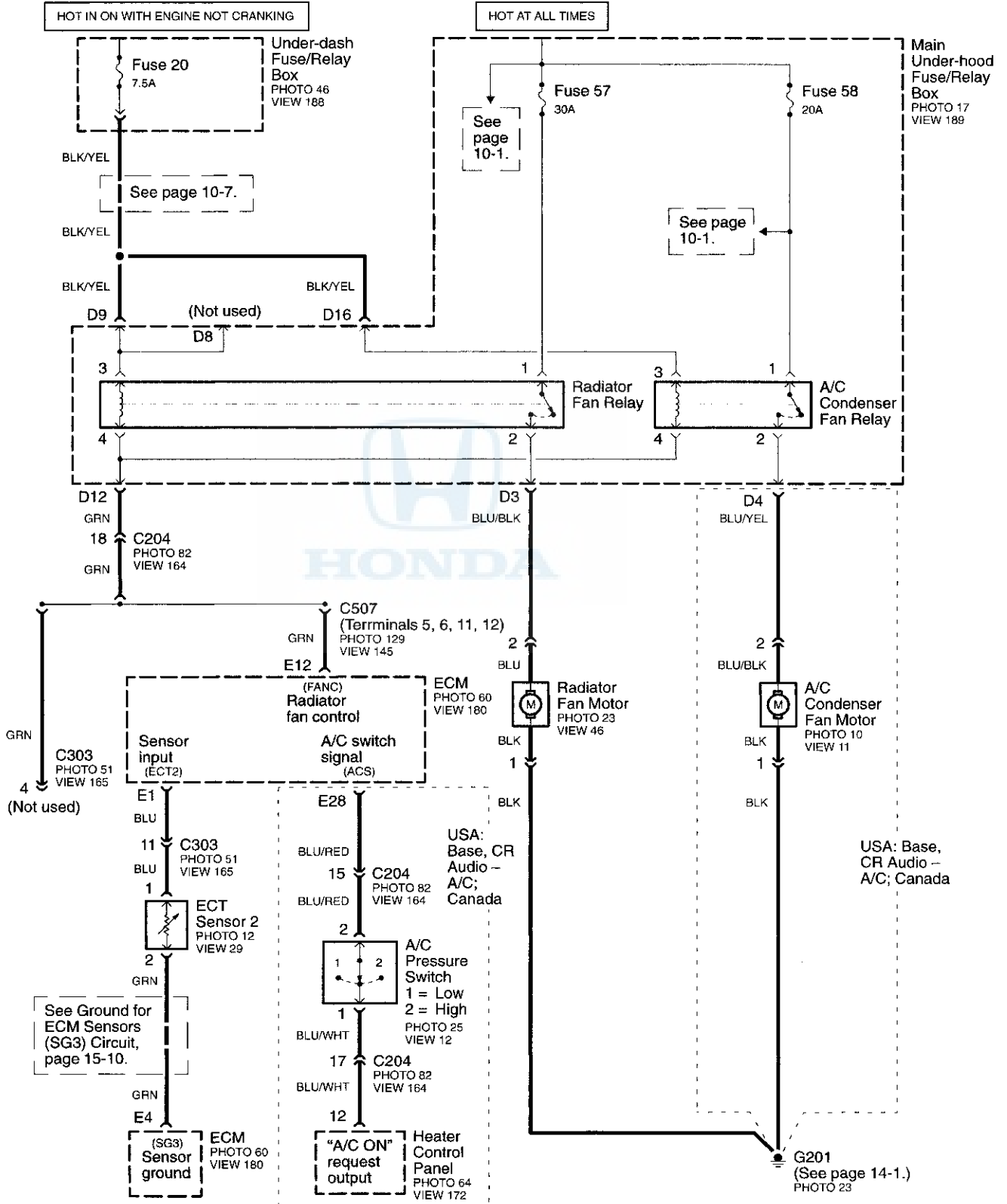

## – **How the Circuit Works**

Voltage is provided at all times to the radiator fan relay contacts through fuse 57 (in the main under-hood fuse/relay box), and to the A/C condenser fan relay contacts through fuse 58 (in the main under-hood fuse/relay box). With the ignition switch ON (II) and the engine not cranking, voltage is provided to the coils of the relays through fuse 20 (in the under-dash fuse/relay box).

The relays are grounded through the ECM. Grounding the relays energizes their coils and applies battery voltage to the radiator and condenser fan motors. Both fans then run until ground is removed from the relay coils.

Refer to the Service Manual (Section 10, Cooling System) for specific tests and troubleshooting procedures.

# Rear Window Defogger

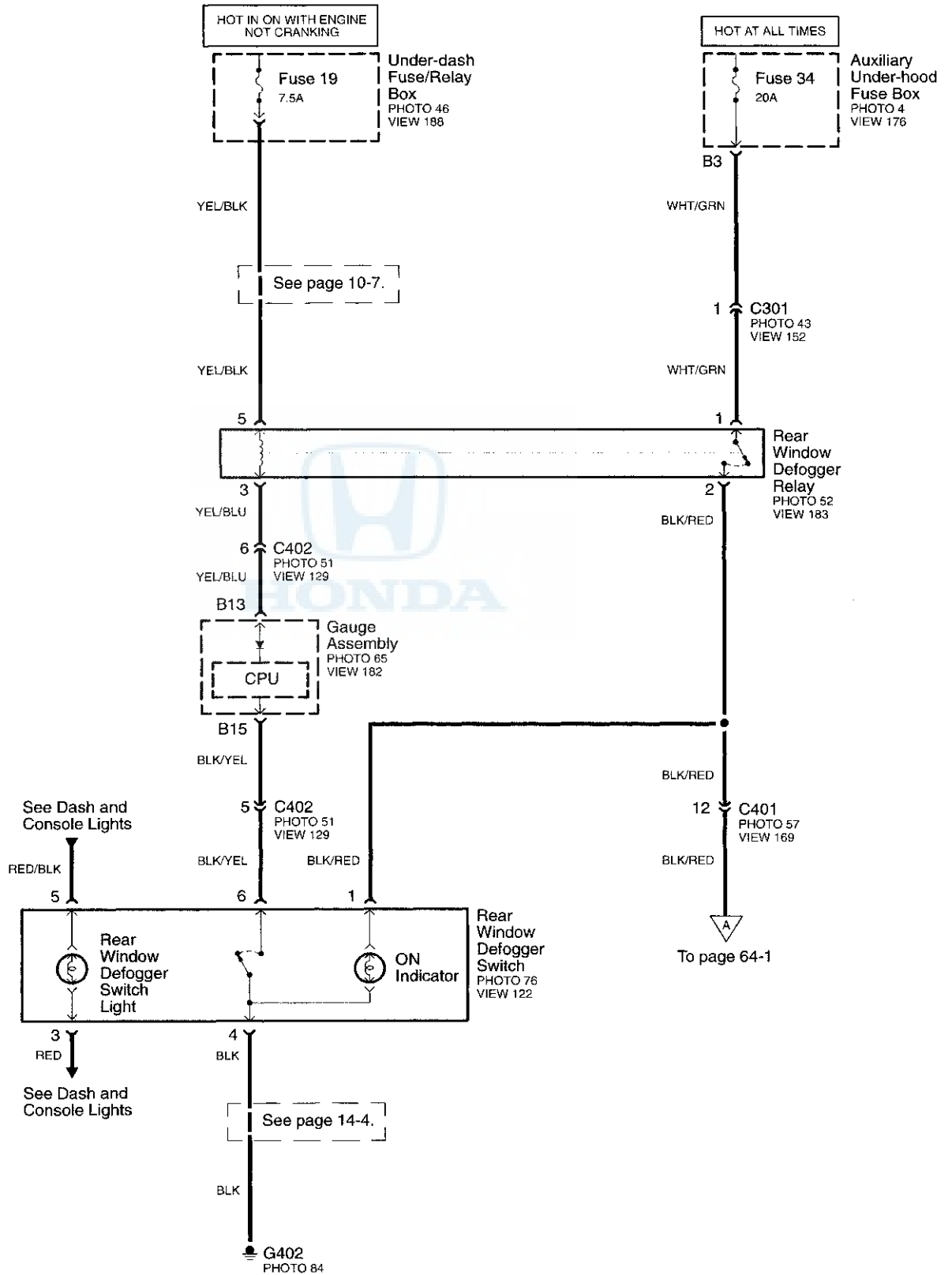



# Lights-on, Key-in and Seat Belt Reminders

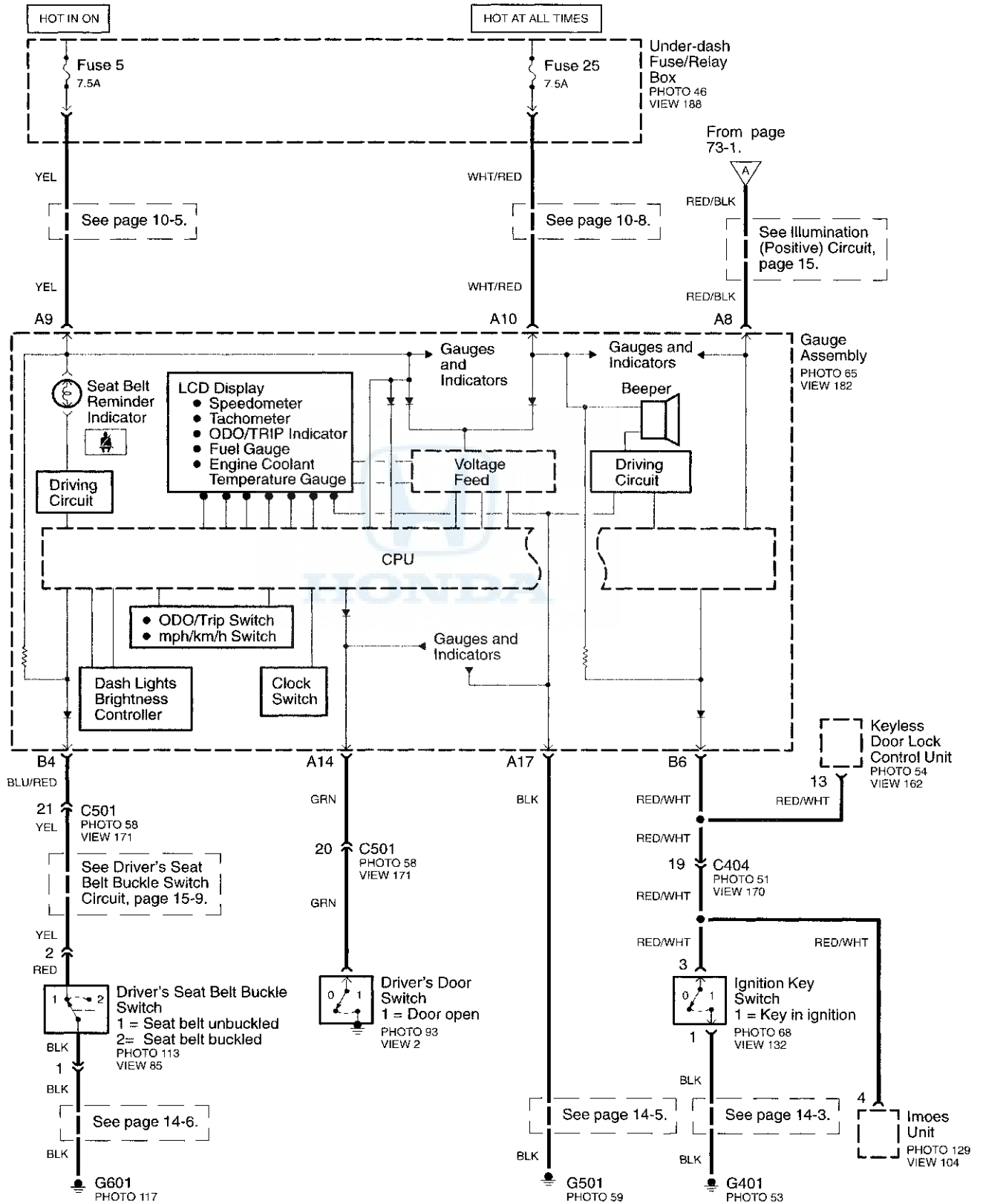



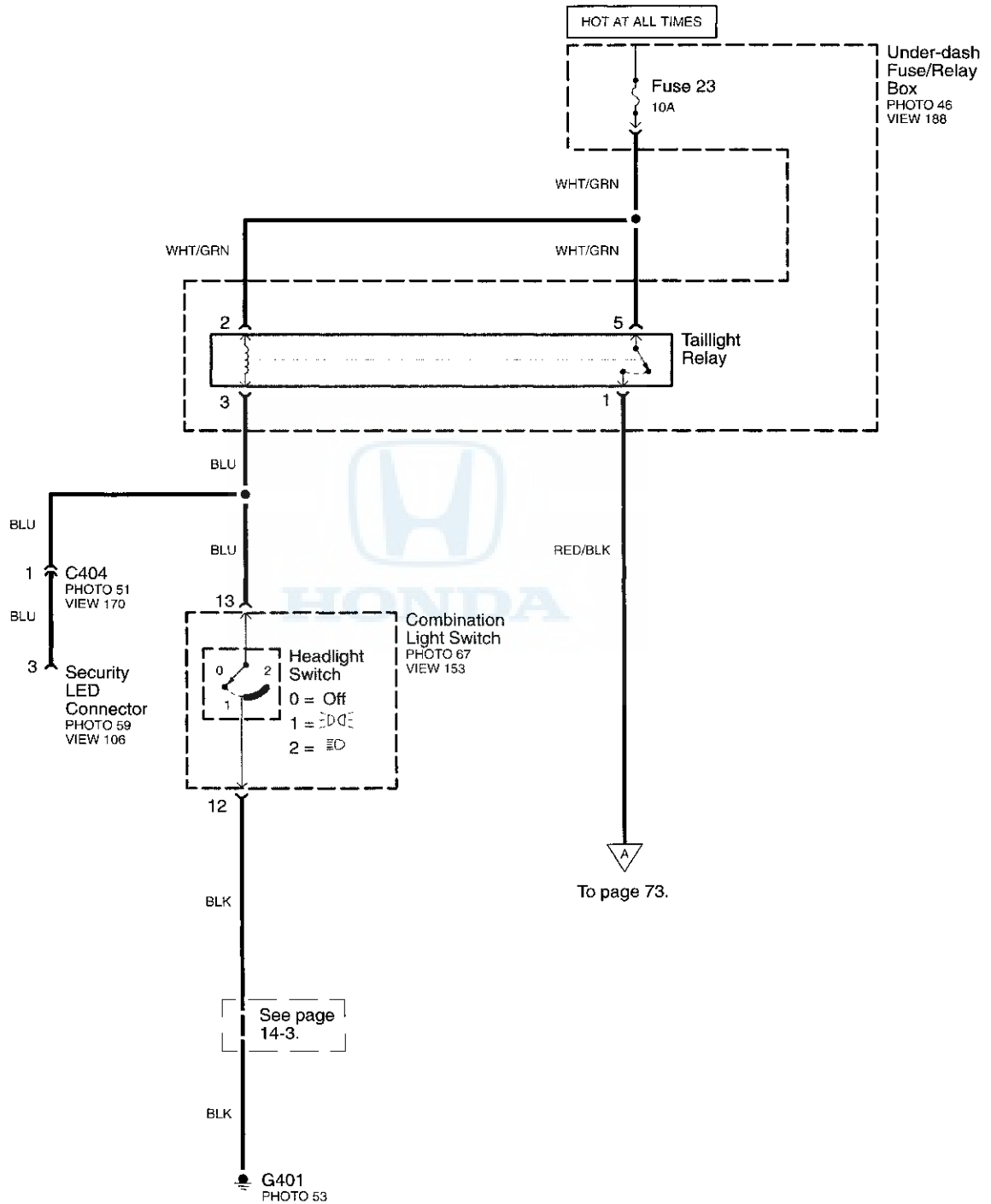

# Gauges and Indicators

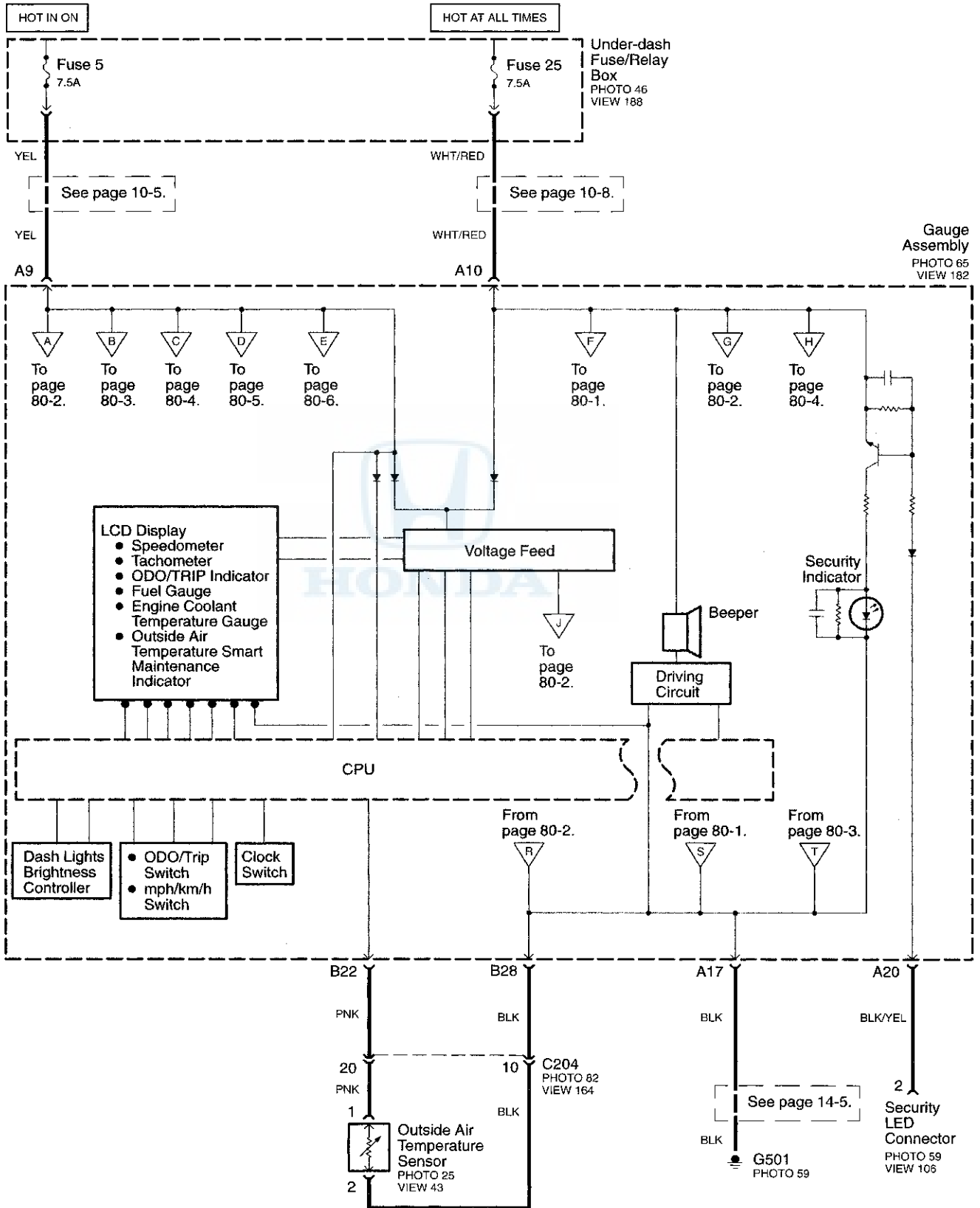

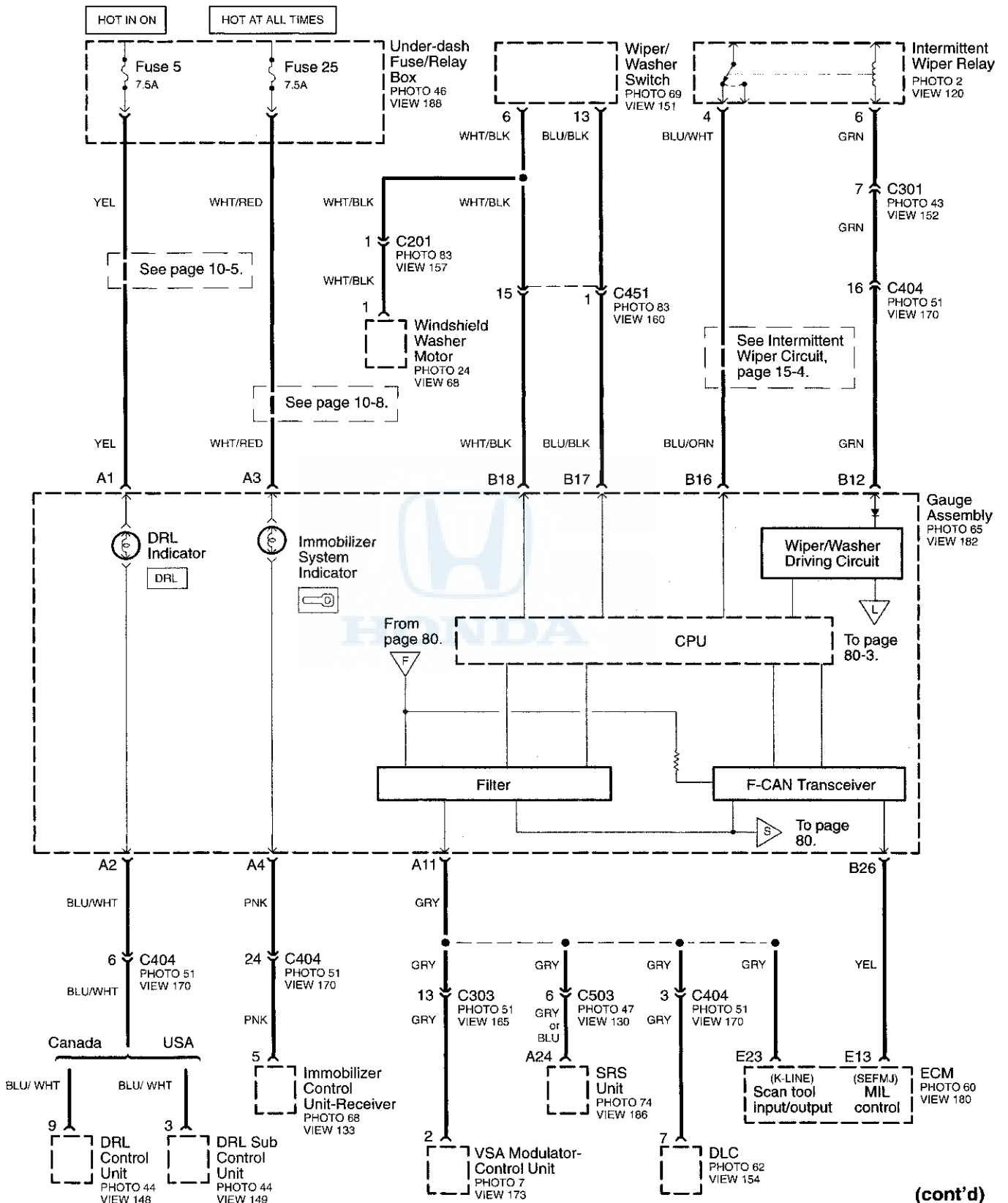

(cont'd)

# Gauges and Indicators

– (cont'd) –

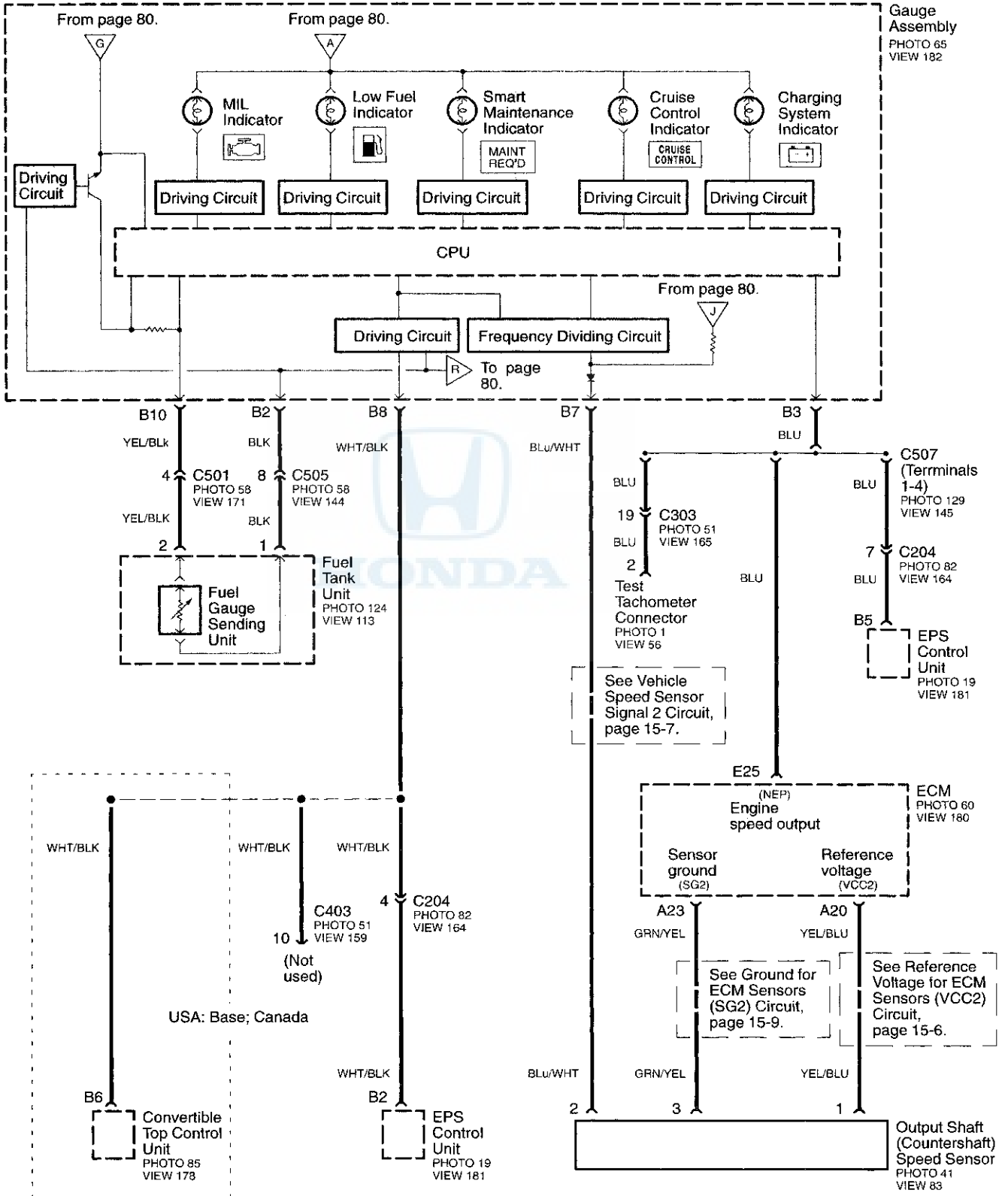

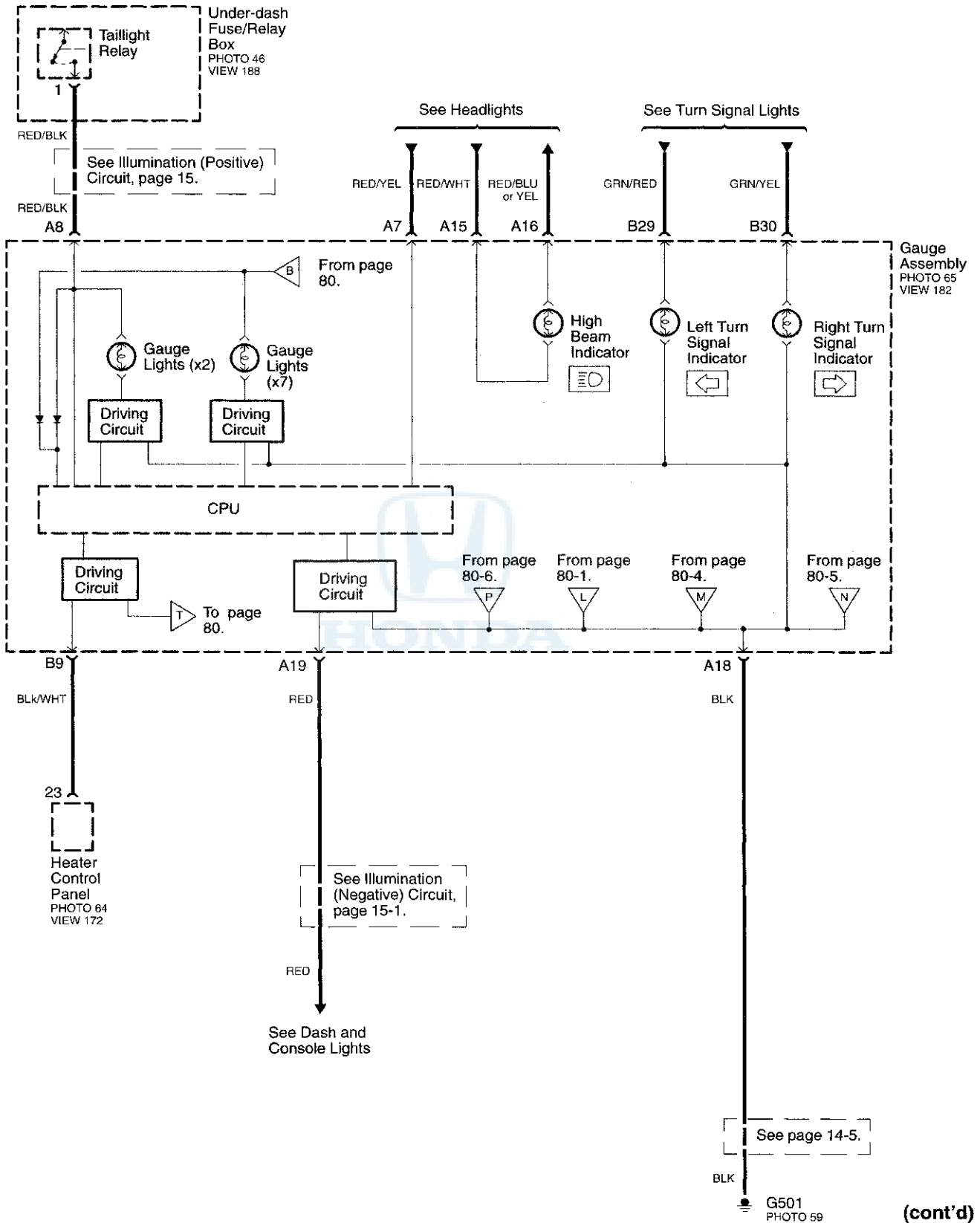

(cont'd)



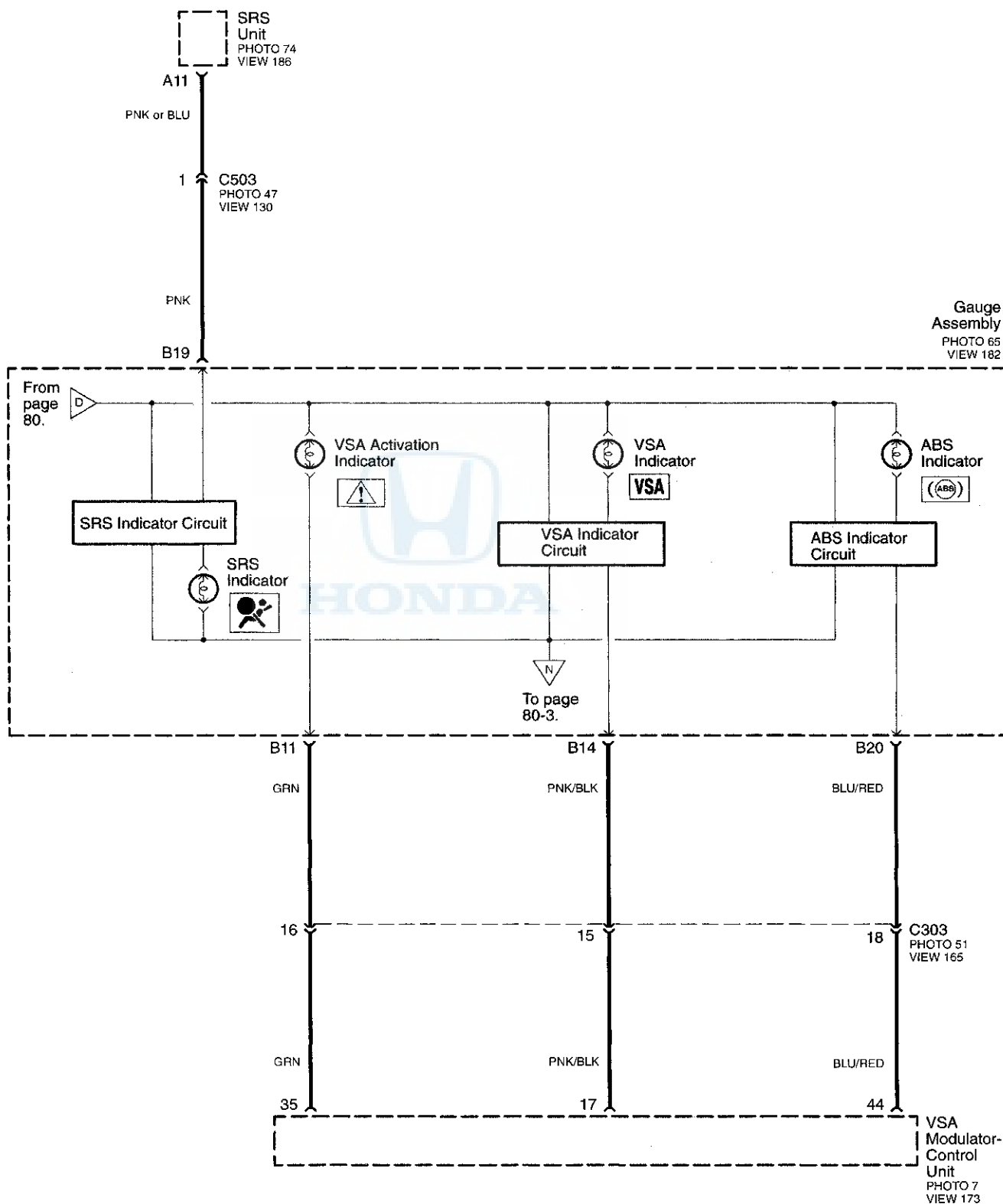

(cont'd)

# Gauges and Indicators

– (cont'd) –

Gauge Assembly  
PHOTO 65  
VIEW 182

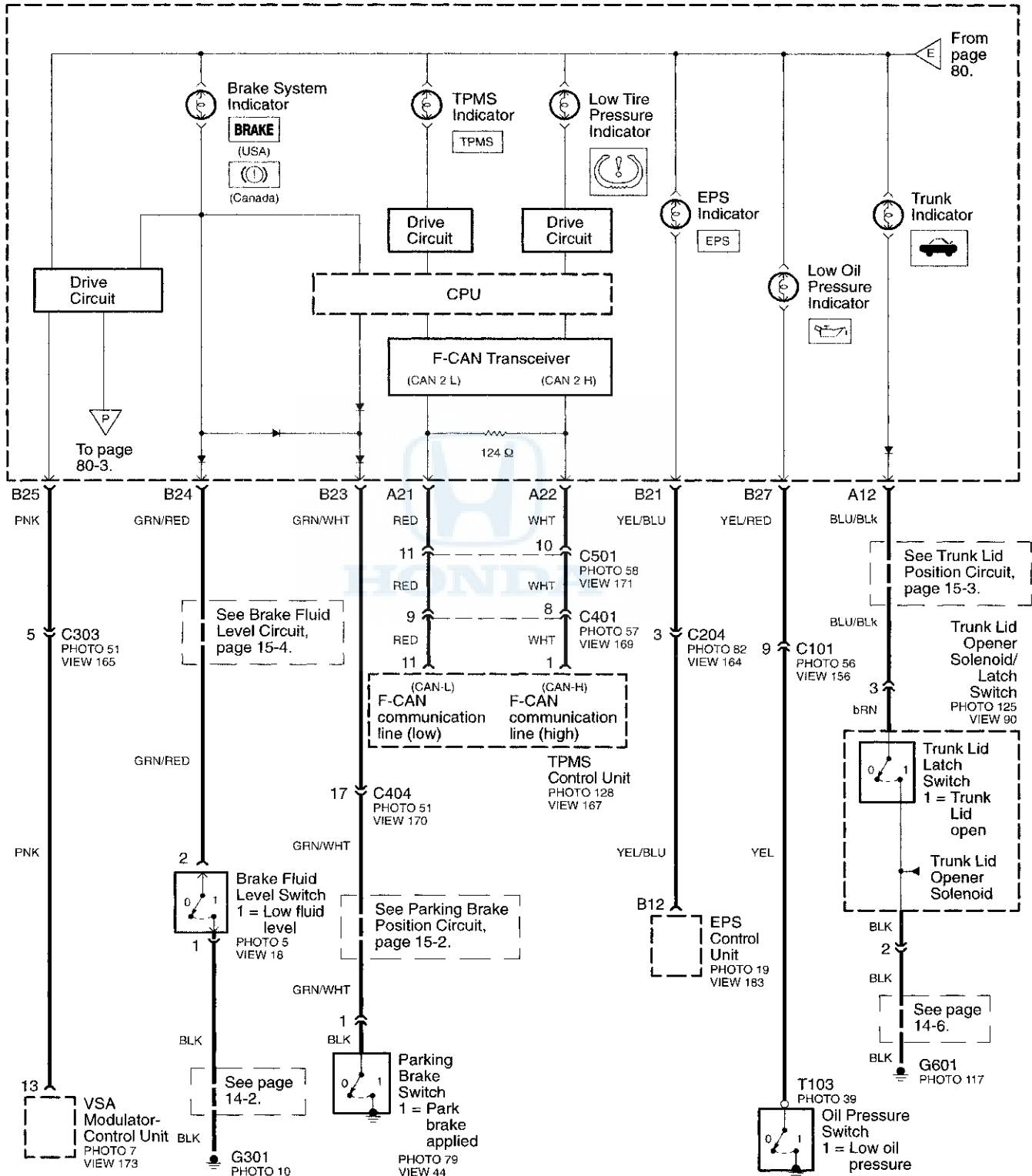





## - How the Circuit Works

The indicator lights are controlled by different conditions in their associated systems. Refer to each associated system to see its entire schematic.

### Engine Coolant Temperature Gauge

The engine coolant temperature gauge (part of the LCD Display) is controlled by the CPU in the gauge assembly. The ECT sensor sends a coolant temperature signal to the ECM. The ECM then sends a coolant temperature signal to the CPU in the gauge assembly through the YEL wire (cavity B26). The CPU controls the LCD display to turn on the proper segments indicating the coolant temperature.

Refer to the Service Manual (Section 22, Gauges) for specific tests or troubleshooting procedures.

### Fuel Gauge and Low Fuel Indicator Light

#### **WARNING**

**Do not smoke while working on the fuel system. Keep open flame away from the work area. Drain fuel only into an approved container.**

The fuel gauge (part of the LCD display) and the low fuel indicator light are controlled by the CPU in the gauge assembly. The fuel gauge sending unit (part of the fuel tank unit) sends a fuel level signal to the CPU in the gauge assembly through the YEL/BLK wire (cavity B10). The signal varies depending on the position of the float in the fuel tank which changes the resistance of the sending unit. The sending unit's resistance values as follows:

Float Position	Resistance ( $\Omega$ )	Height (mm) (in.)
F	11-13	81.2 (3.2)
1/2	52-58	152 (6.0)
LOW	114.4-120.4	214.3 (8.4)
E	130-132	221.9 (8.7)

The CPU controls the LCD display to turn on the proper segments indicating the fuel level. When the fuel level drops below the LOW level, the CPU grounds the low fuel indicator light, which turns the light on.

Refer to the Service Manual (Section 11, Fuel Supply System) for specific tests or troubleshooting procedures.

### Speedometer and Odometer

The speedometer and odometer (part of the LCD display) are controlled by the CPU in the gauge assembly. The CPU receives a pulsing input from the Output Shaft (Countershaft) Speed Sensor. The pulse rate increases as the car accelerates. The frequency and duration of these input pulses are measured by the CPU. The CPU controls the LCD display to turn on the proper segments indicating the vehicles speed and mileage.

Refer to the Service Manual (Section 22, Gauges) for specific tests or troubleshooting procedures.

### Tachometer

The tachometer (part of the LCD display) is controlled by the CPU in the gauge assembly. The CPU receives a pulsing input from the ECM. The frequency and duration of these input pulses are measured by the CPU. The CPU controls the LCD display to turn on the proper segments indicating the engine speed.

Refer to the Service Manual (Section 22, Gauges) for specific tests or troubleshooting procedures.

# TPMS (Tire Pressure Monitoring System)

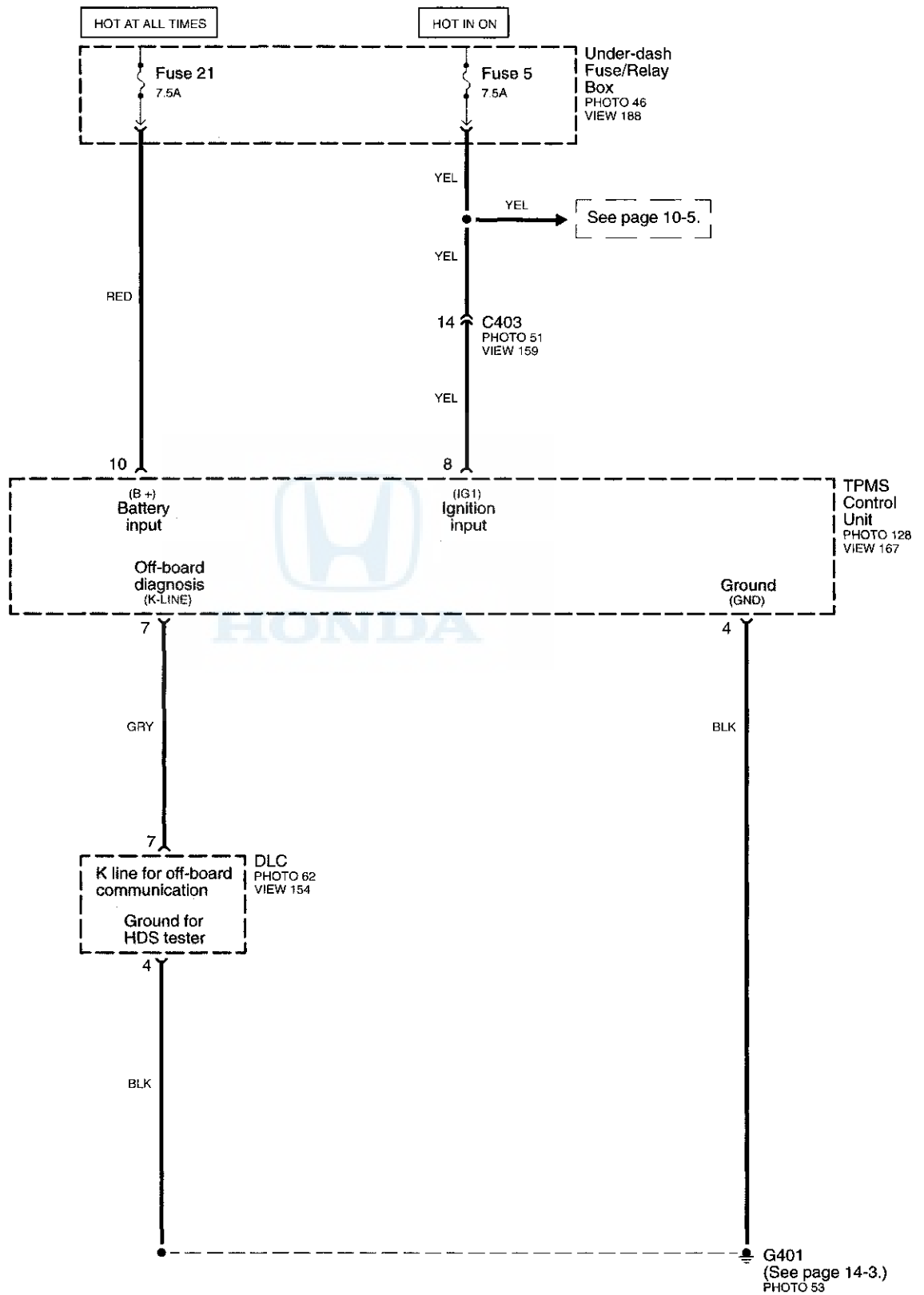

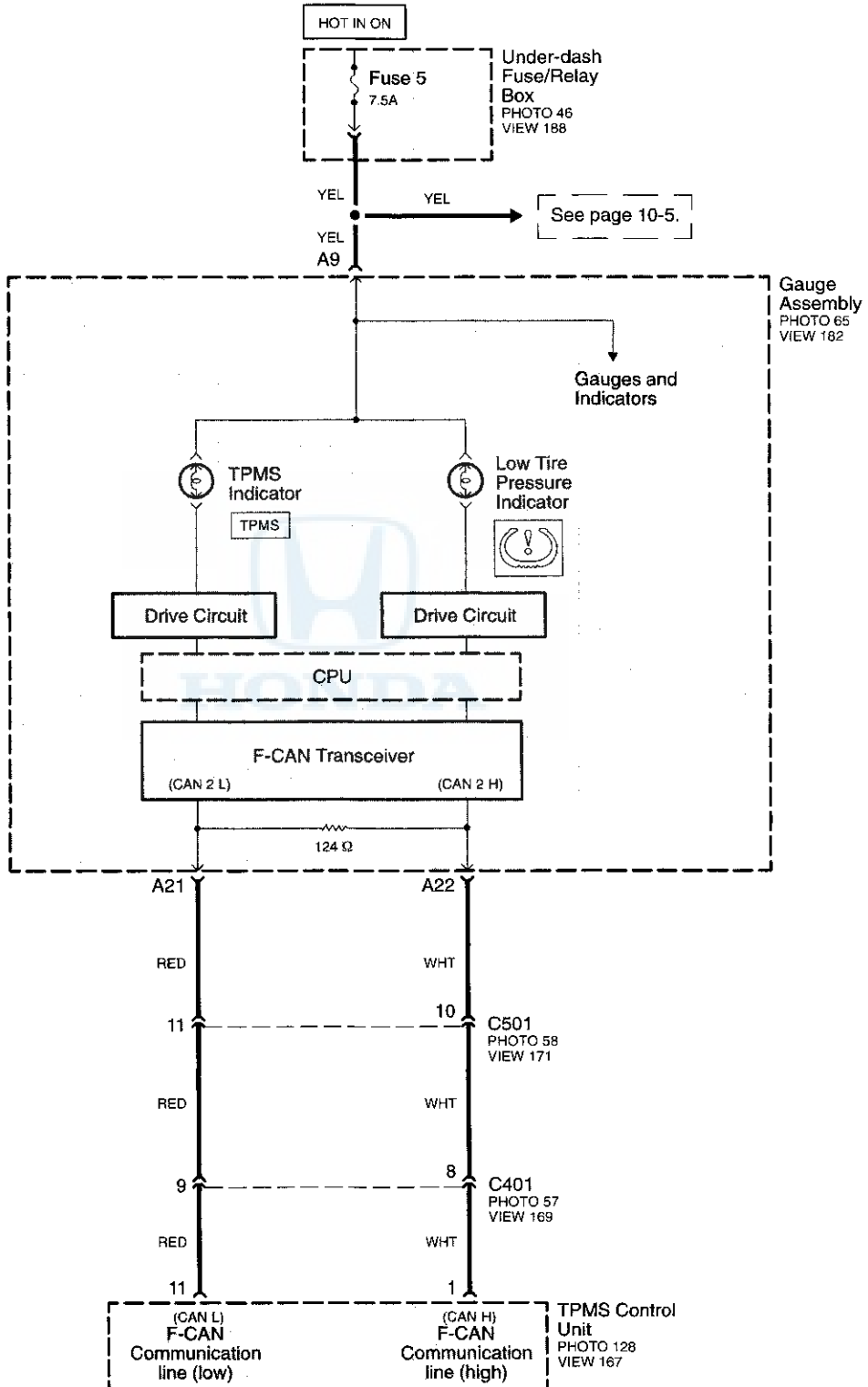

# Wiper/Washer

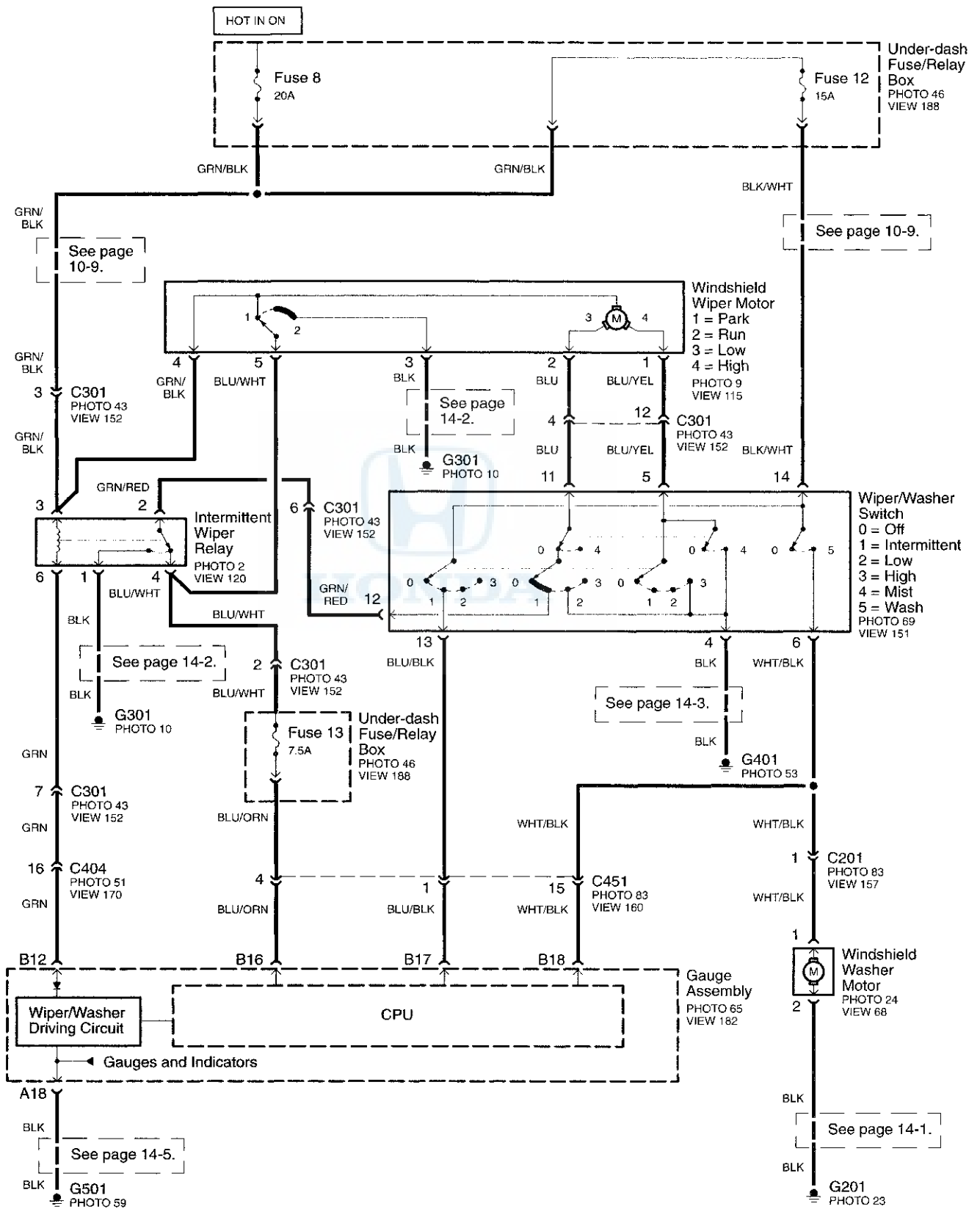



## – How the Circuit Works

### Low Speed

With the ignition switch in ON (II), battery voltage is applied to the windshield wiper motor through fuse 8 (in the under-dash fuse/relay box), and to the windshield wiper/washer switch through fuse 12 (in the under-dash fuse/relay box). When you move the wiper switch to LOW, the low speed winding of the motor is grounded through the low contact of the wiper/washer switch, and the wipers run at low speed.

### Park/Off

When you turn the wiper switch to OFF, ground is provided for the low speed winding of the windshield wiper motor through the wiper switch, intermittent wiper relay, and the cam switch on the motor, to G301. The wipers then run at low speed until the cam switch on the motor moves to PARK, removing the ground, which stops the wipers in the park position.

### High Speed

When you move the wiper switch to HIGH, the high speed windings of the windshield wiper motor are grounded through the HIGH contact of the wiper/washer switch, and the wipers run at high speed.

### Intermittent

When you move the wiper switch to INT, battery voltage is applied through fuse 12 (in the under-dash fuse/relay box) and the windshield wiper/washer switch to the CPU in the gauge assembly. The CPU sends a signal to the wiper/washer driving circuit, which energizes the intermittent wiper relay by applying a ground signal to the relay coil. The wipers then make a single sweep every few seconds.

### Mist

When you push the wiper/washer lever up and hold it, the high speed winding of the windshield wiper motor is grounded through the MIST contact in the wiper/washer switch. The wipers will sweep at high speed as long as you hold the lever up. When you release the lever, the PARK/OFF function then takes over, and the wipers stop in the PARK position.

### Washer

When you pull the wiper/washer lever toward you, battery voltage is applied to the windshield washer motor and the CPU in the gauge assembly. The CPU grounds the coil of the intermittent wiper relay. The relay, in turn, grounds the low speed windings of the wiper motor. The washer motor then pumps washer fluid onto the windshield, and the wipers run at low speed. When you release the lever, the wipers make one more sweep and then stop.

Refer to the Service Manual (Section 22, Body Electrical) for testing and troubleshooting procedures.

# Exterior Lights

## - Headlights (USA)

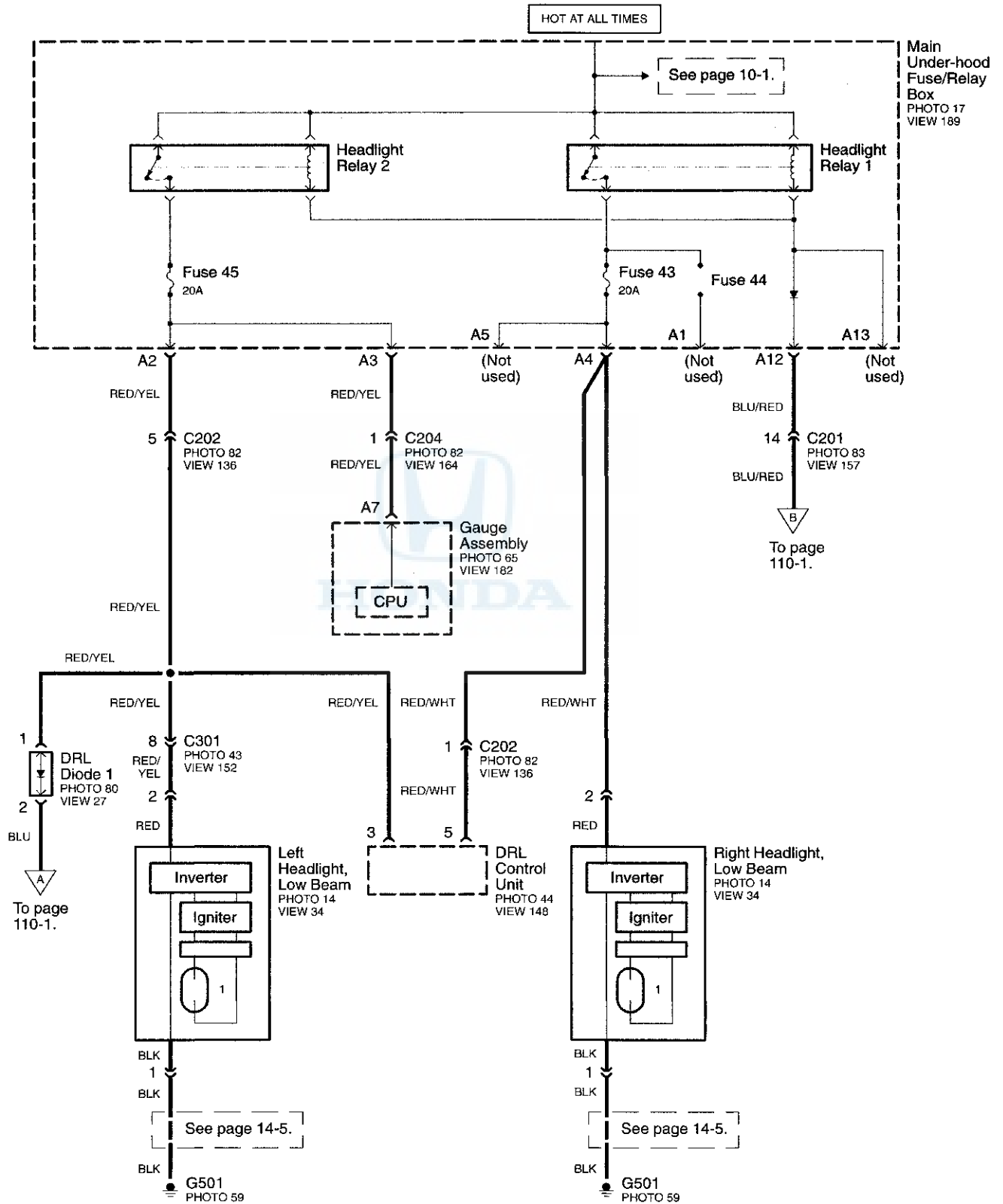

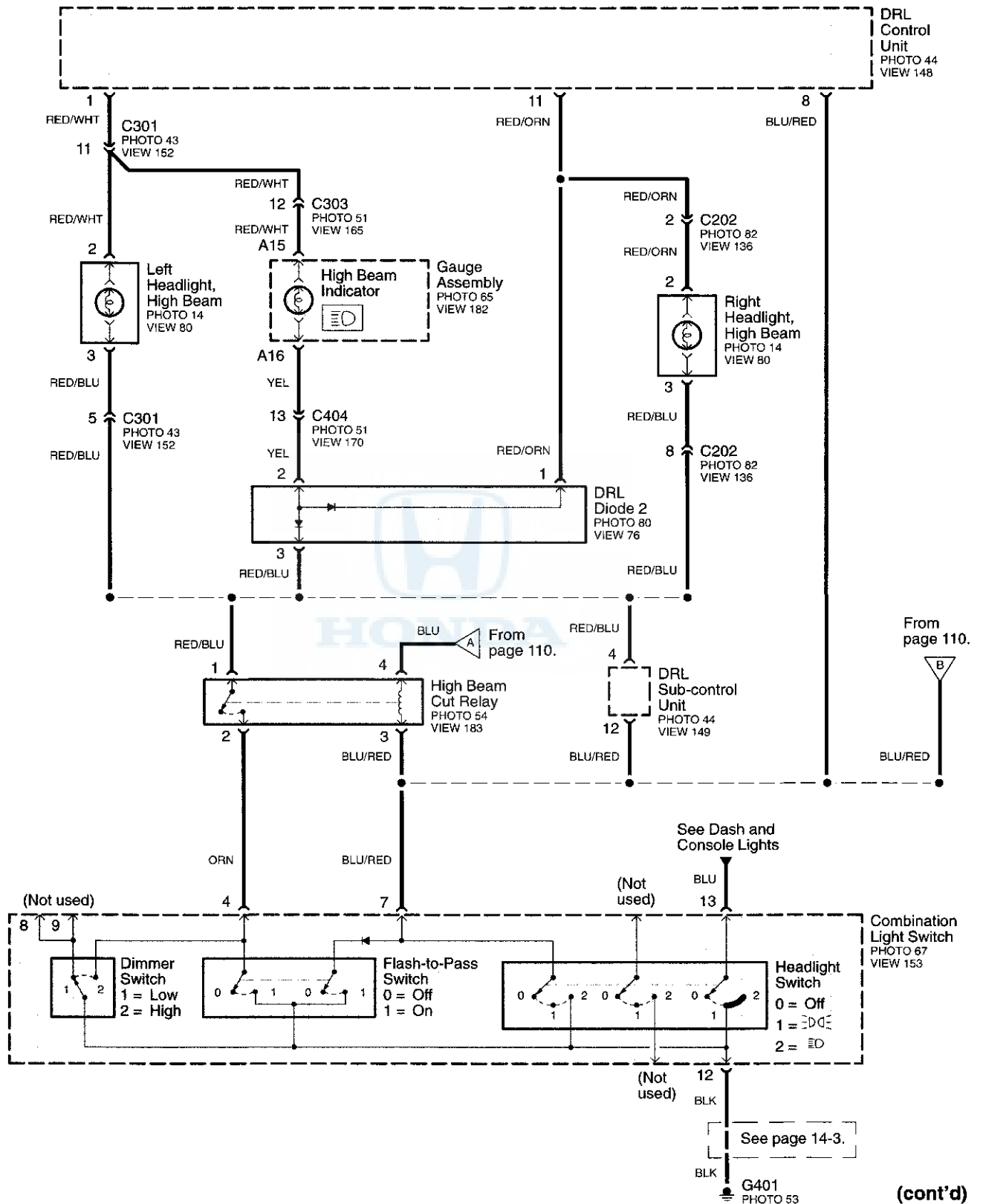
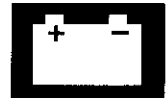

(cont'd)

# Exterior Lights

## - Headlights (USA) (cont'd)

NOTE: See page 10-4 for details of Fuse 19.

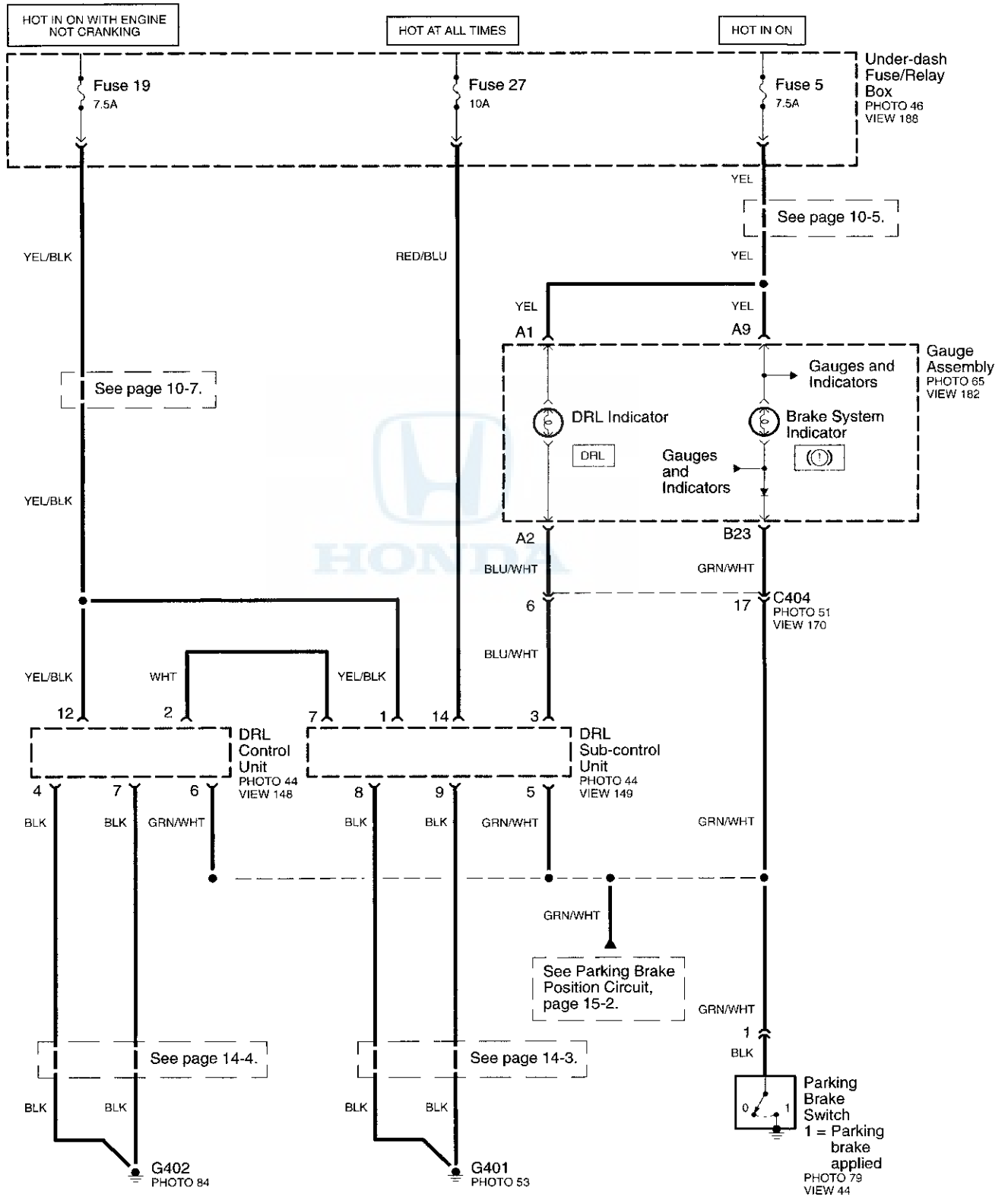





## – How the Circuit Works (USA)

### **⚠ WARNING**

A transient high tension (25,000 v) occurs at the bulb sockets of the high intensity discharge (HID) lamps when the combination light switch is turned ON. It may cause serious electrical shock or electrocution if you do not observe the cautions below.

### **⚠ CAUTION**

- Never turn on the combination light switch before fitting the HID bulbs to their bulb sockets and completing the reassembly of the headlight assembly.
- Do not service the headlight assembly in wet, conditions, such as rain or snow, near a sprinkler system, or when your hands are wet to prevent electrocution.
- Do not touch the surface of the HID bulbs with your bare hands and do not stain it with any oils or fats.
- Do not disassemble the inverter unit and the igniter unit.
- Do not turn on the HID bulb by using a power source other than the battery mounted on the vehicle.

### High and Low Beams

The headlight relays receive battery voltage at all times. When you turn the headlight switch to the HEAD position, ground is applied through the BLU/RED wire to the coils of the headlight and high beam cut relays. The headlight relays are then energized, applying battery voltage to the left and right low beam headlights, the DRL control unit, and the high beam cut relay through fuses 43 and 45 (in the main under-hood fuse/relay box). The DRL control unit provides power to the left and right high beam headlights. The high beam cut relay is energized, and the low beam bulbs come on with the dimmer switch in LOW or HIGH, because the opposite terminal is tied to ground. The ground path for the high beams and indicator is through the closed contacts of the high beam cut relay and the dimmer switch. With the dimmer switch in LOW, the path is interrupted, and the high beams remain off, but in HIGH a ground path is provided, and the high beams come on.

### Flash-to-Pass

When you hold the flash-to-pass switch in the ON position, ground is applied through the BLU/RED wire to the coils of the headlight and high beam cut relays. The headlight relays are then energized, applying battery voltage to the left and right low beam headlights, the DRL control unit, and the high beam cut relay through fuses 43 and 45 (in the main under-hood fuse/relay box). The DRL control unit provides power to the left and right high beam headlights. The high beam cut relay is energized, and the low beam bulbs come on, because the opposite terminal is tied to ground. The high beams and indicator also come on, because a path to ground is provided to the opposite terminal through the closed flash-to-pass switch and the closed contacts of the high beam cut relay.

# Exterior Lights

## - Headlights (Canada)

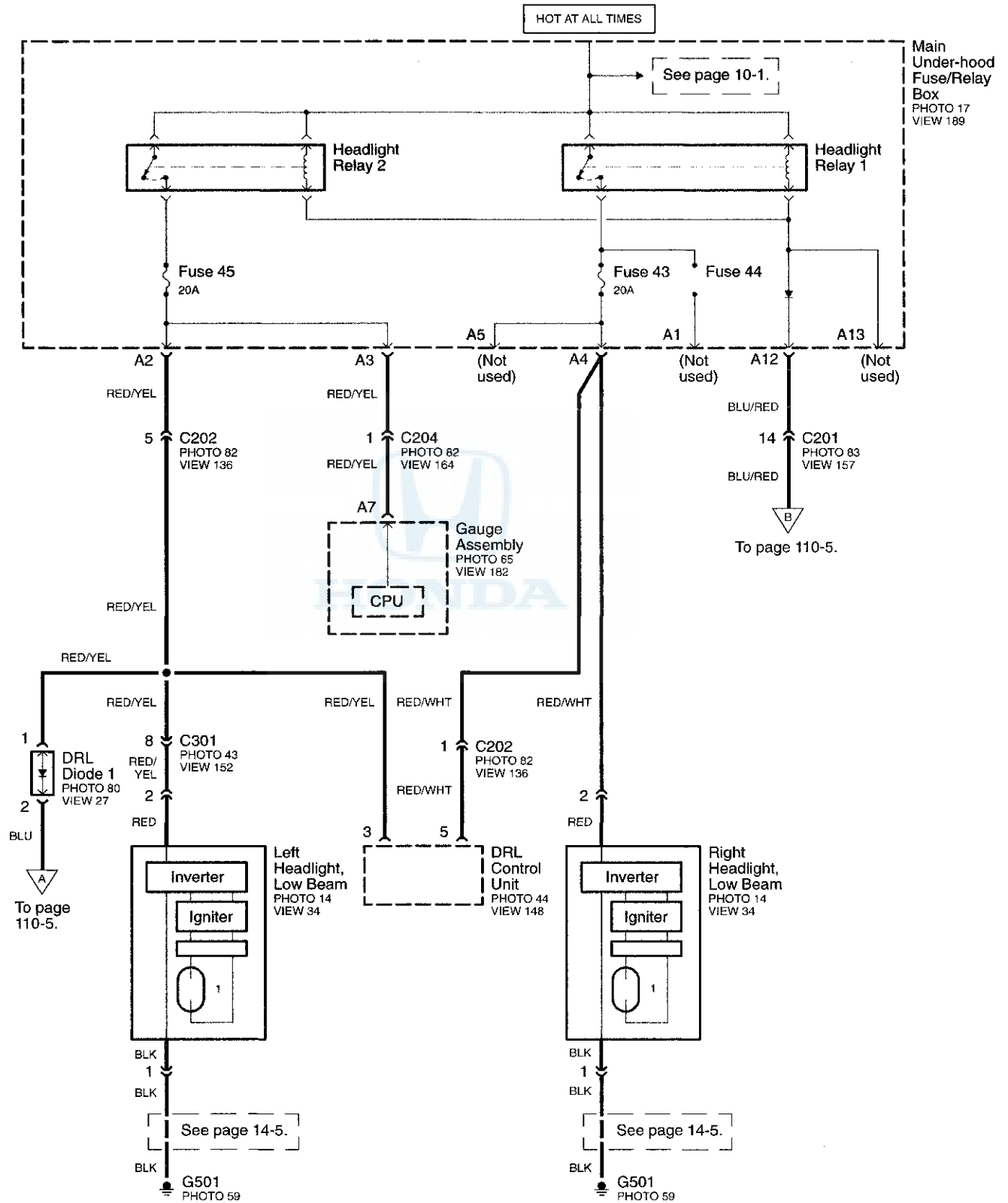

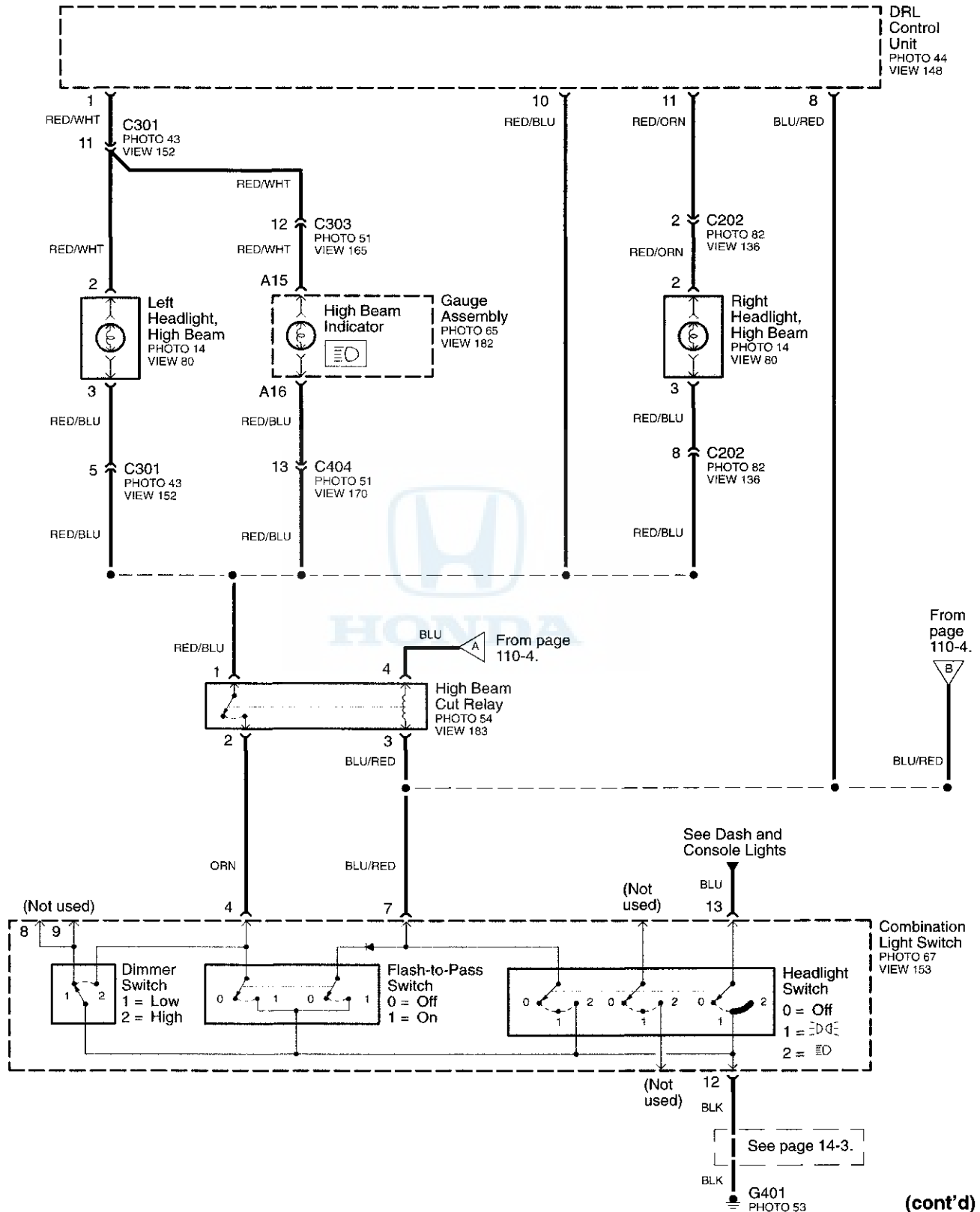
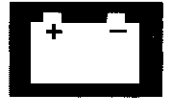

(cont'd)

# Exterior Lights

## - Headlights (Canada) (cont'd)

NOTE: See page 10-4 for details of Fuse 19.

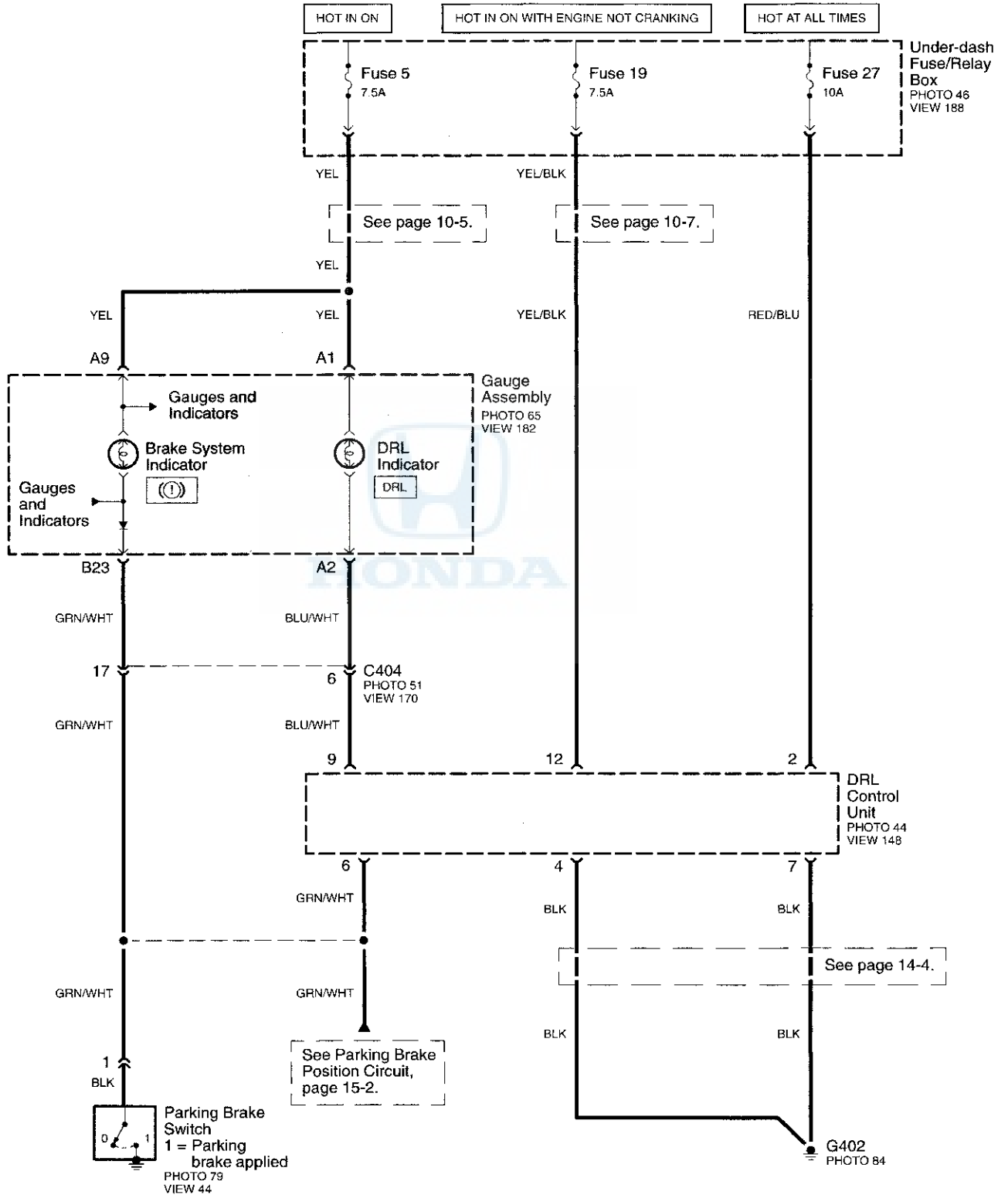



## - How the Circuit Works (Canada)

### **⚠ WARNING**

A transient high tension (25,000 v) occurs at the bulb sockets of the high intensity discharge (HID) lamps when the combination light switch is turned ON. It may cause serious electrical shock or electrocution if you do not observe the cautions below.

### **⚠ CAUTION**

- Never turn on the combination light switch before fitting the HID bulbs to their bulb sockets and completing the reassembly of the headlight assembly.
- Do not service the headlight assembly in wet conditions, such as rain or snow, near a sprinkler system, or when your hands are wet to prevent electrocution.
- Do not touch the surface of the HID bulbs with your bare hands and do not stain it with any oils or fats.
- Do not disassemble the inverter unit and the igniter unit.
- Do not turn on the HID bulb by using a power source other than the battery mounted on the vehicle.

### **High and Low Beams**

The headlight relays receive battery voltage at all times. When you turn the headlight switch to the HEAD position, ground is applied through the BLU/RED wire to the coils of the headlight and high beam cut relays. The headlight relays are then energized, applying battery voltage to the left and right low beam headlights, the DRL control unit, and the high beam cut relay through fuses 43 and 45 (in the main under-hood fuse/relay box). The DRL control unit provides power to the left and right high beam headlights. The high beam cut relay is energized, and the low beam bulbs come on with the dimmer switch in LOW or HIGH, because the opposite terminal is tied to ground. The ground path for the high beams and indicator is through the closed contacts of the high beam cut relay and the dimmer switch. With the dimmer switch in LOW the path is interrupted and the high beams remain off, but in HIGH a ground path is provided, and the high beams come on.

### **Flash-to-Pass**

When you hold the flash-to-pass switch in the ON position, ground is applied through the BLU/RED wire to the coils of the headlight and high beam cut relays. The headlight relays are then energized, applying battery voltage to the left and right low beam headlights, the DRL control unit, and the high beam cut relay through fuses 43 and 45 (in the main under-hood fuse/relay box). The DRL control unit provides power to the left and right high beam headlights. The high beam cut relay is energized, and the low beam bulbs come on, because the opposite terminal is tied to ground. The high beams and indicator also come on, because the opposite terminal is provided a path to ground through the closed flash-to-pass switch and the closed contacts of the high beam cut relay.

### **DRL**

When you turn the ignition switch to ON (II) with the parking brake released, the DRL control unit supplies about 6 volts to the RED/BLU wire (cavity 10), about 12 volts to the RED/WHT wire (cavity 1), and ground to the RED/ORN wire (cavity 11). This provides about 6 volts to both high beam headlights, causing them to come on at reduced brightness. If you apply the parking brake, ground is applied to the DRL control unit at the GRN/WHT wire. If the parking brake is applied before you turn the ignition switch to ON (II), the daytime mode will remain off until you release the parking brake. Once the high beams are in the daytime mode, applying the parking brake will not turn them off. When you switch to low beams, high beams, or flash-to-pass operation, ground is applied to the DRL control unit through the BLU/RED wire, and the control unit then turns off the daytime running lights mode.

Refer to the Service Manual (Section 22, Body Electrical) for specific tests or troubleshooting procedures.





# - Back-up Lights

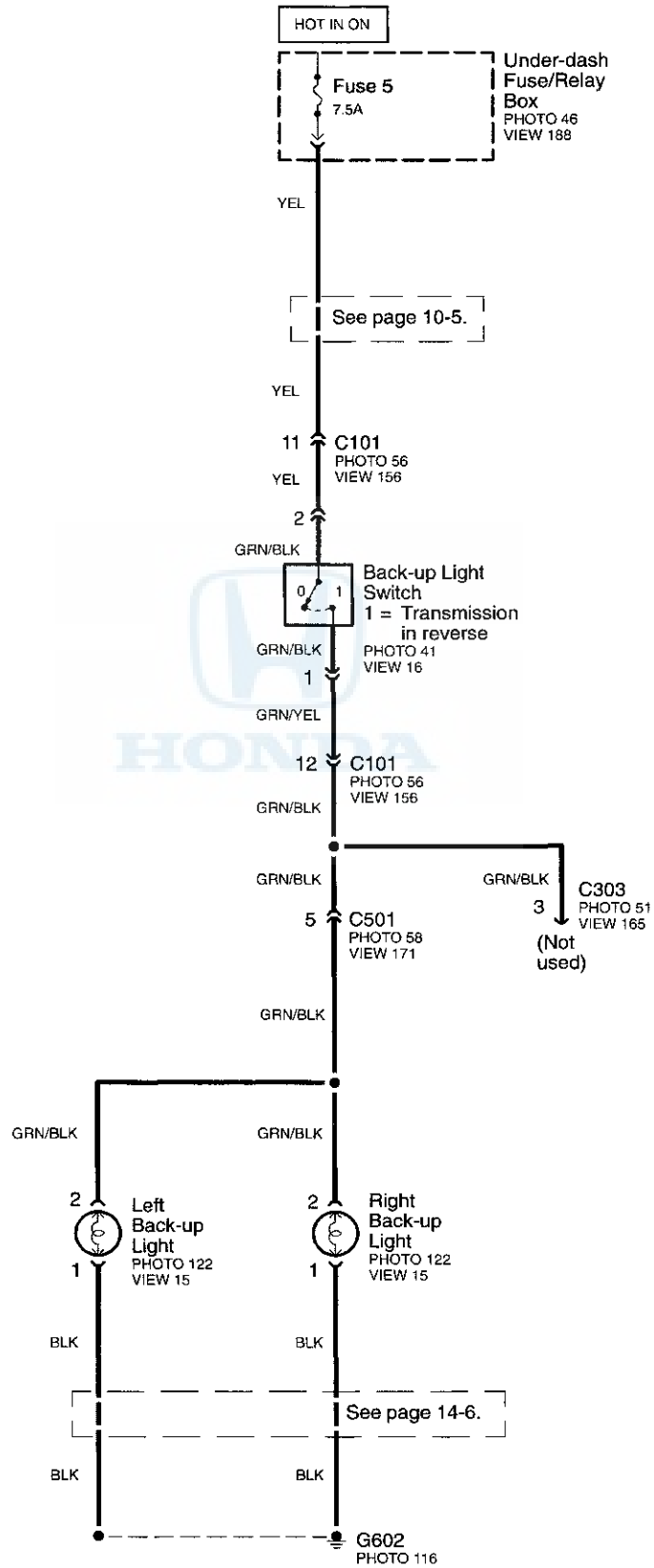

# Exterior Lights

## - Taillights, Parking, Side Marker and License Plate Lights

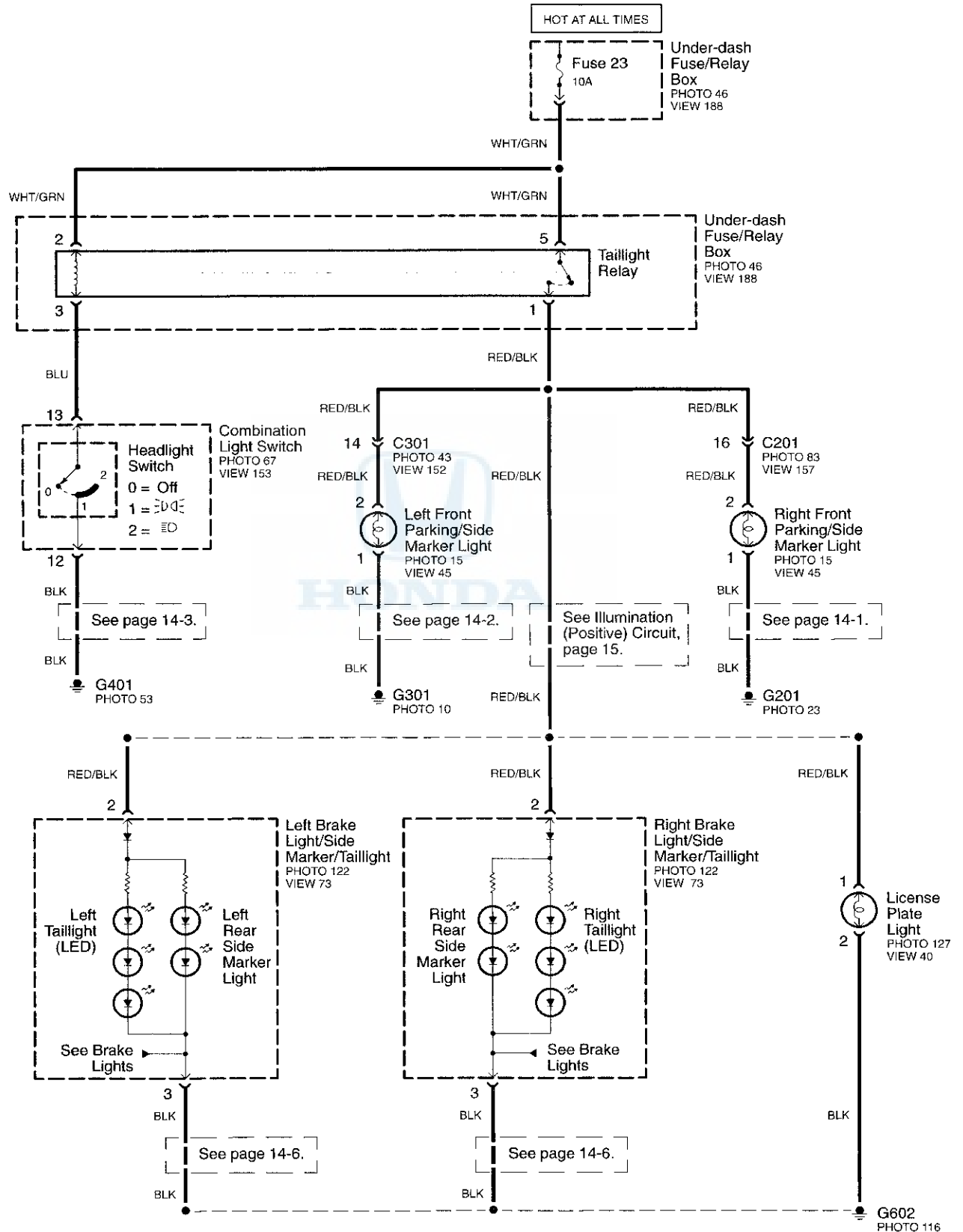





# - Brake Lights

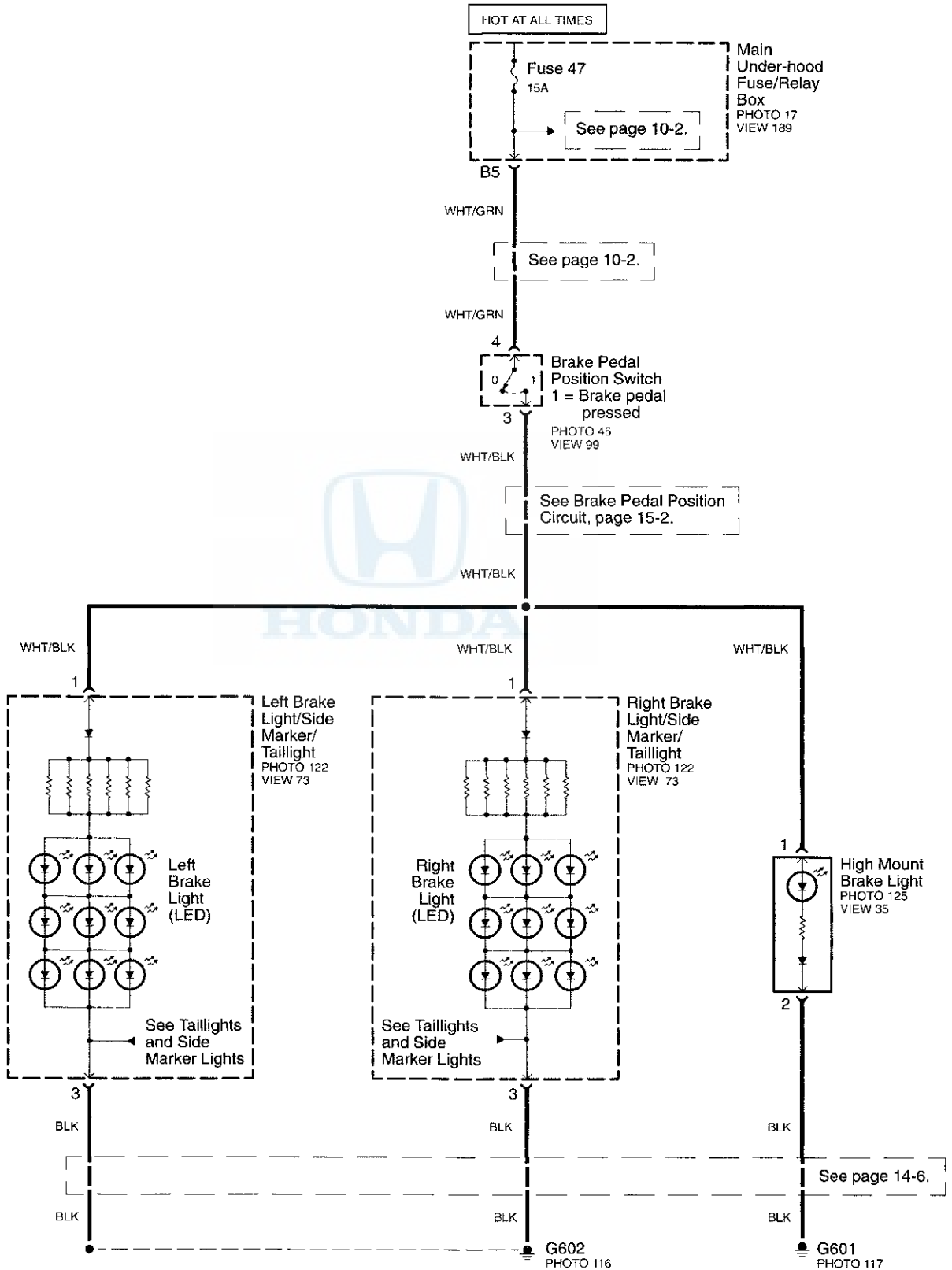

# Interior Lights

## - Ceiling Light/Spotlights and Trunk Light

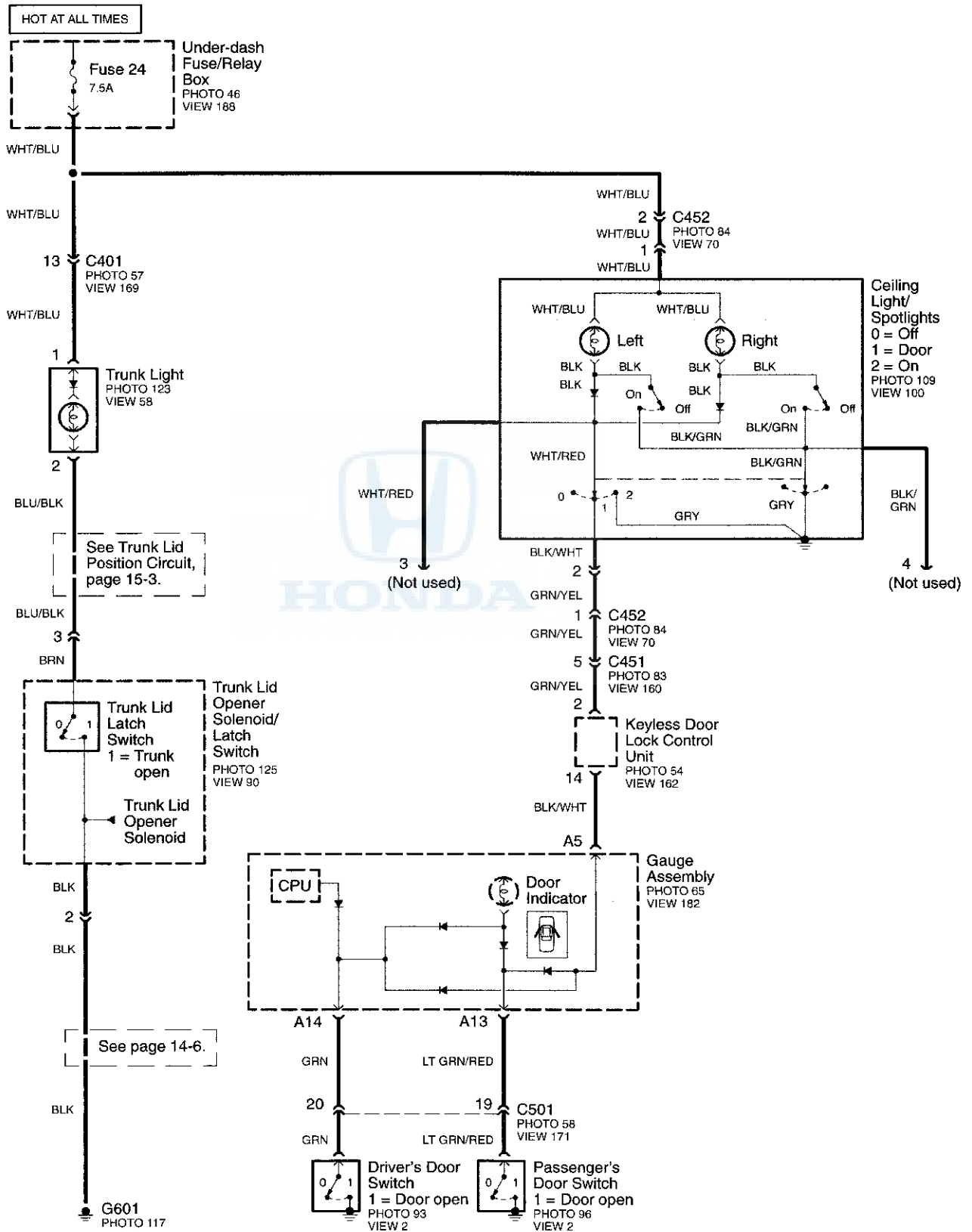



## - Dash and Console Lights

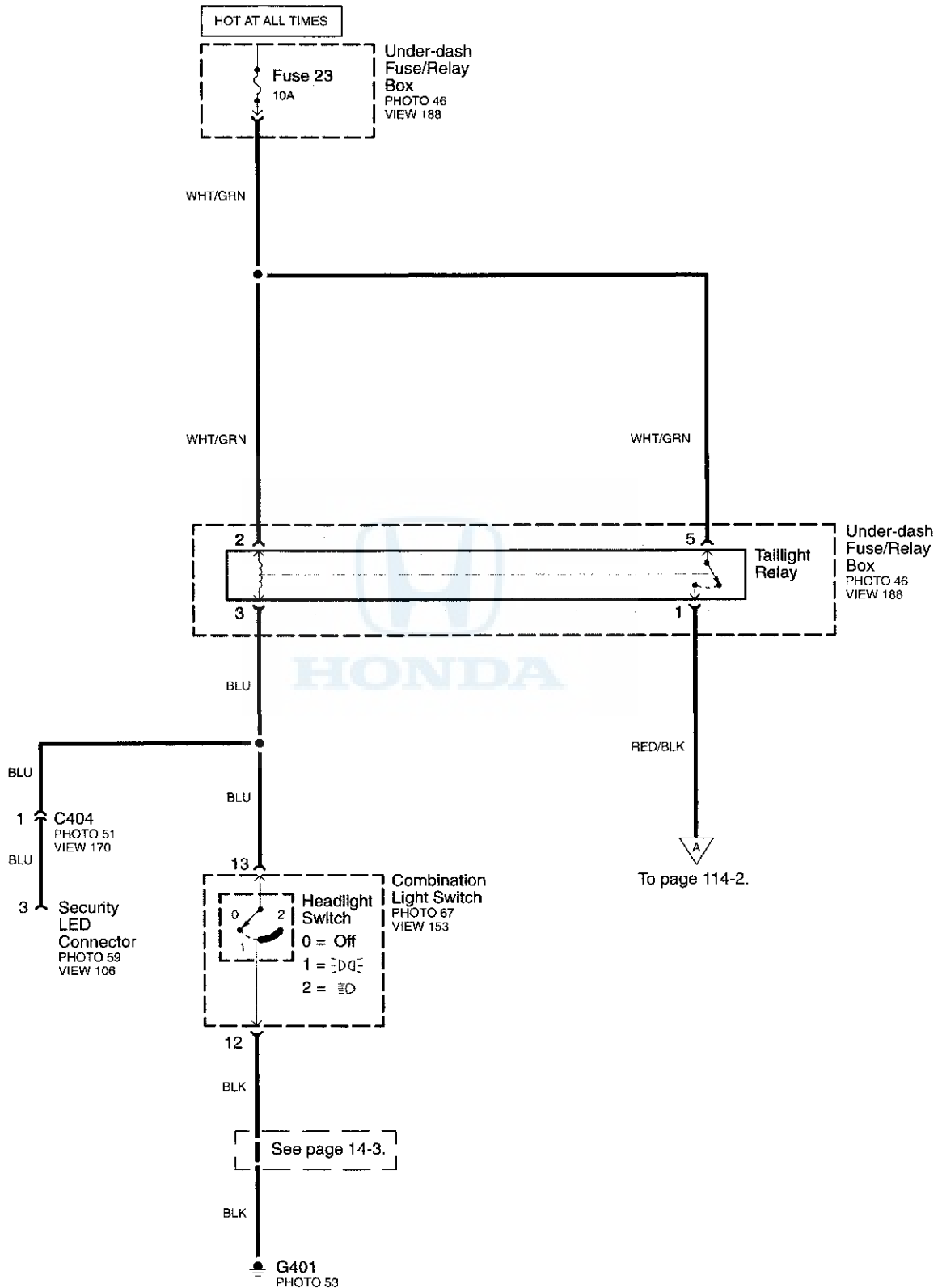

(cont'd)

# Interior Lights

## - Dash and Console Lights

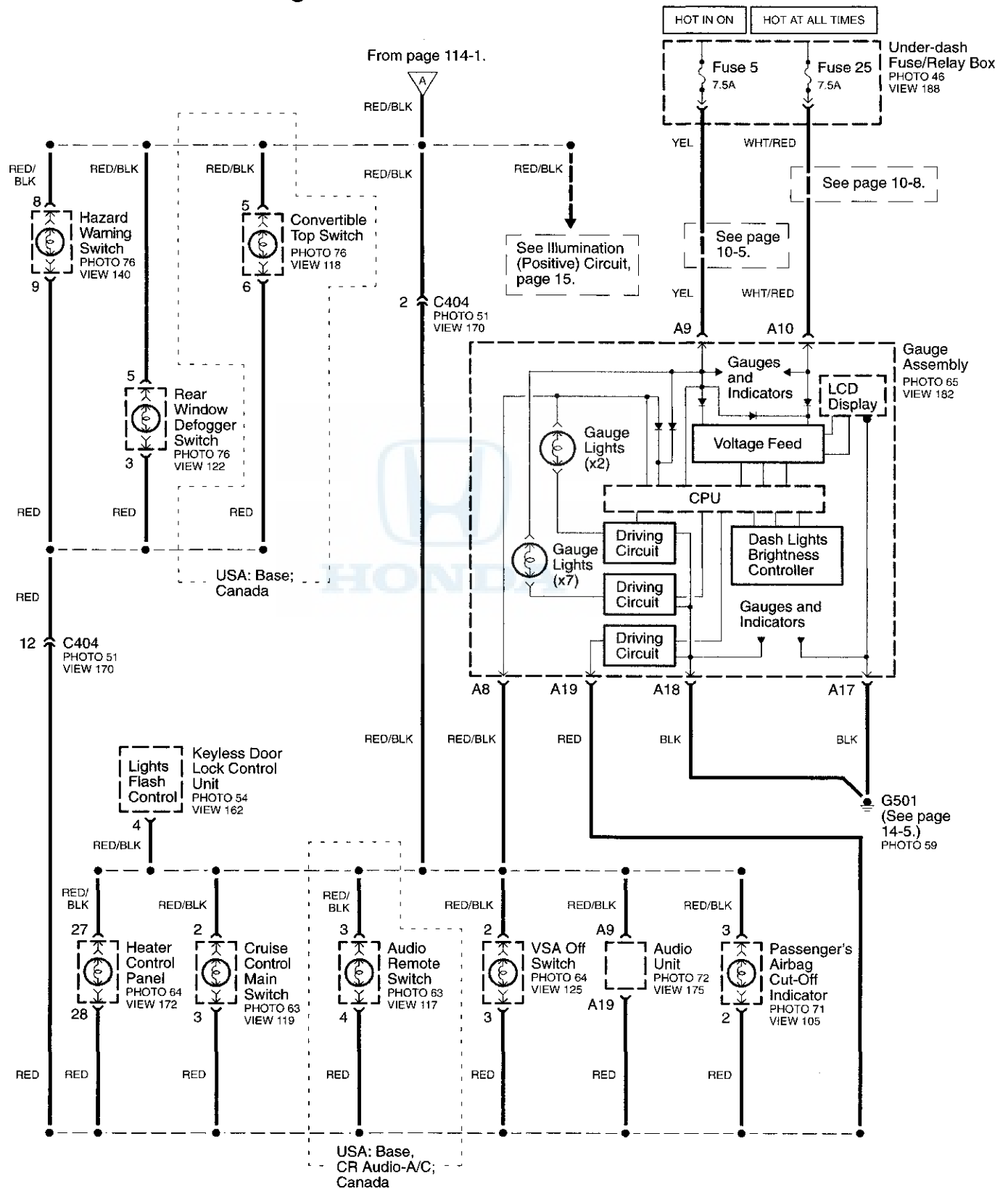

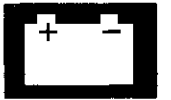

# Power Windows

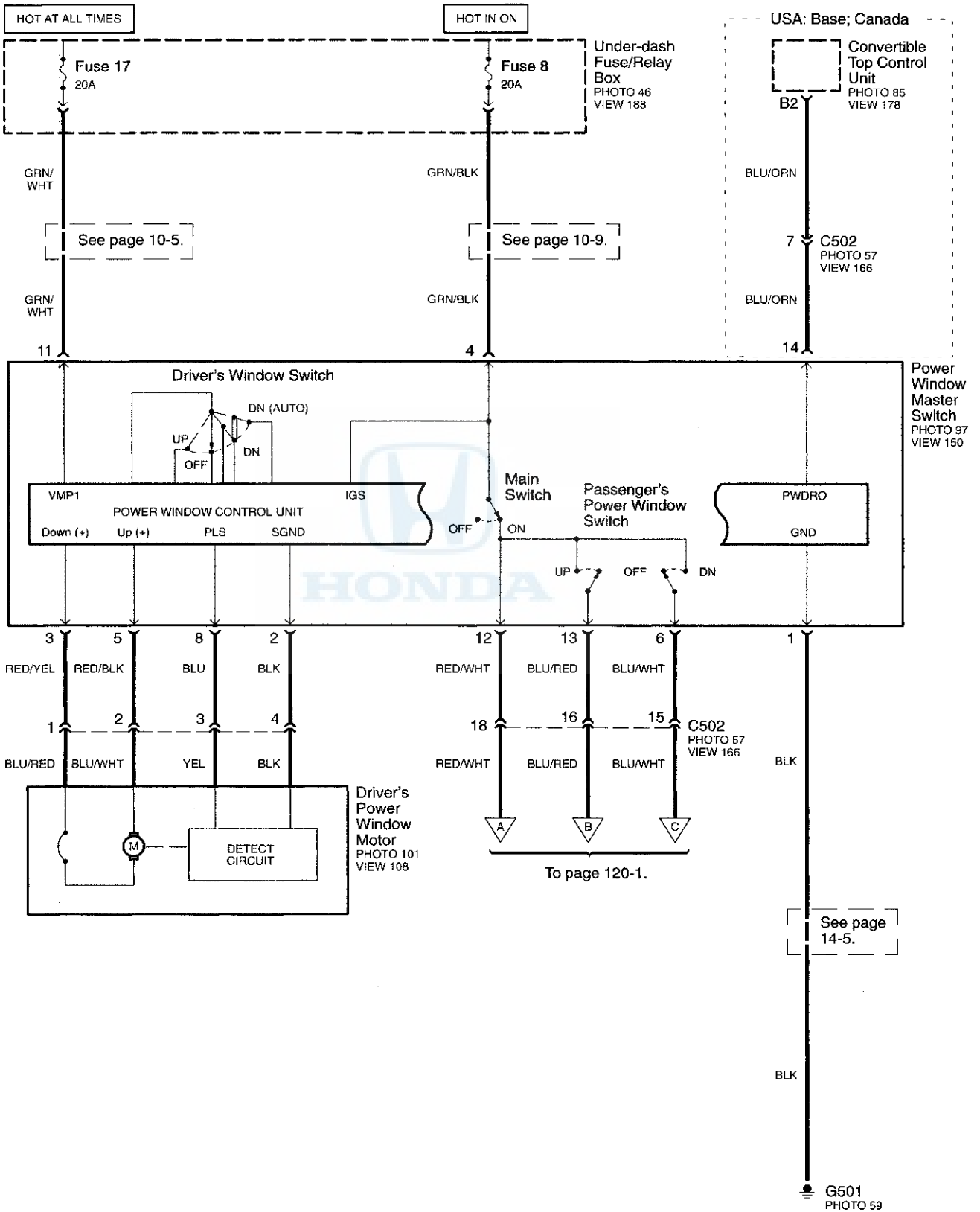

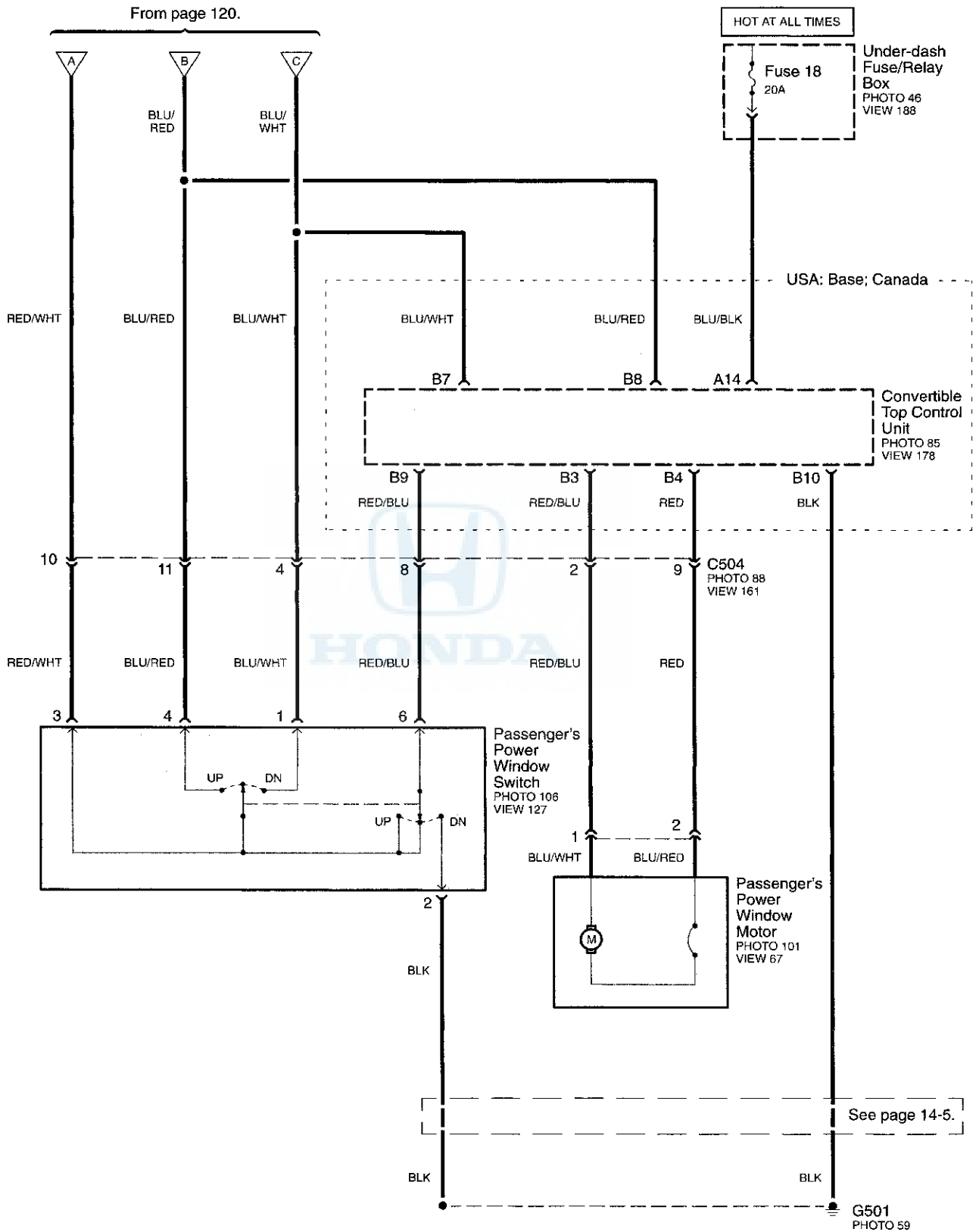

# Convertible Top

- USA: Base; Canada

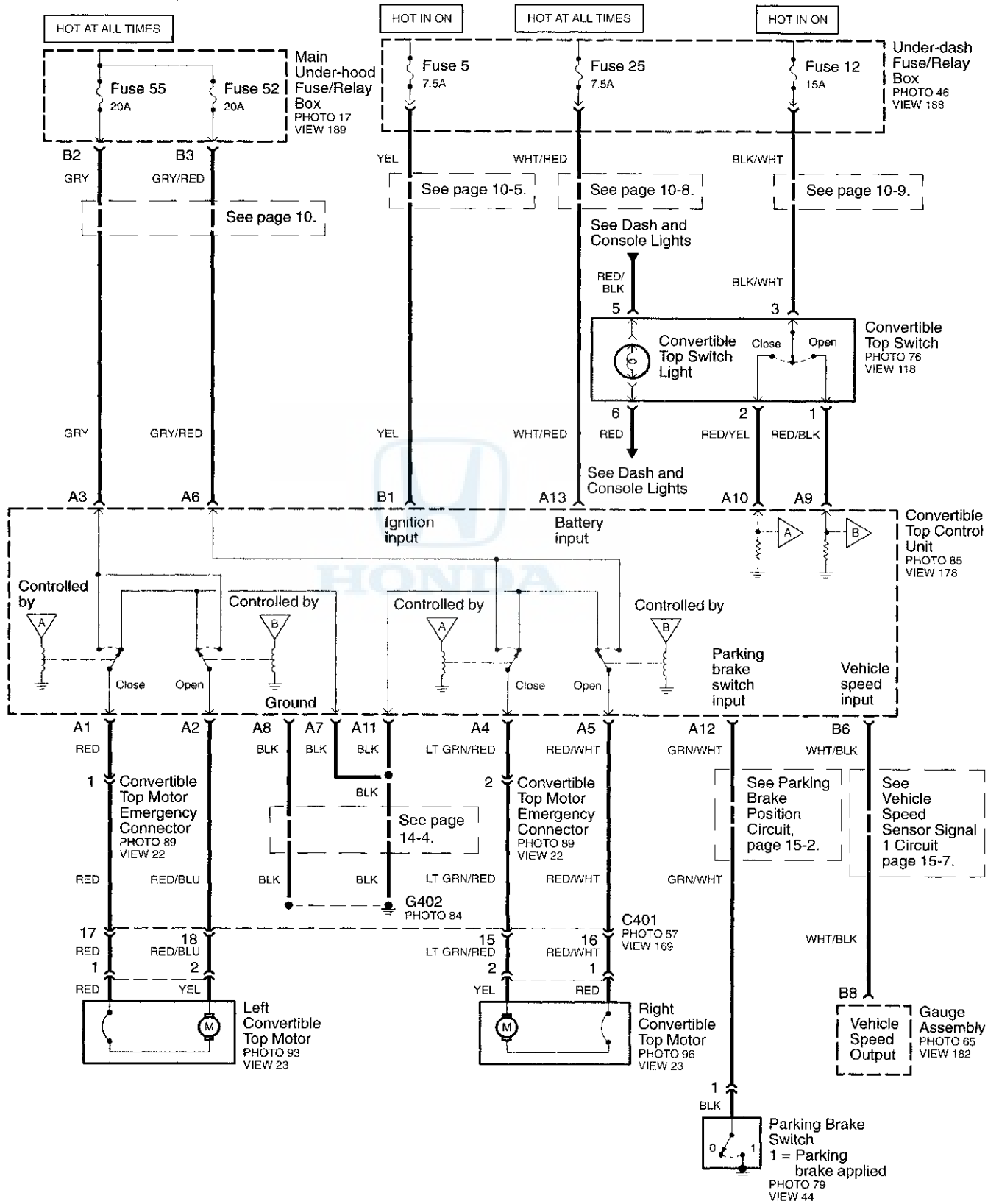



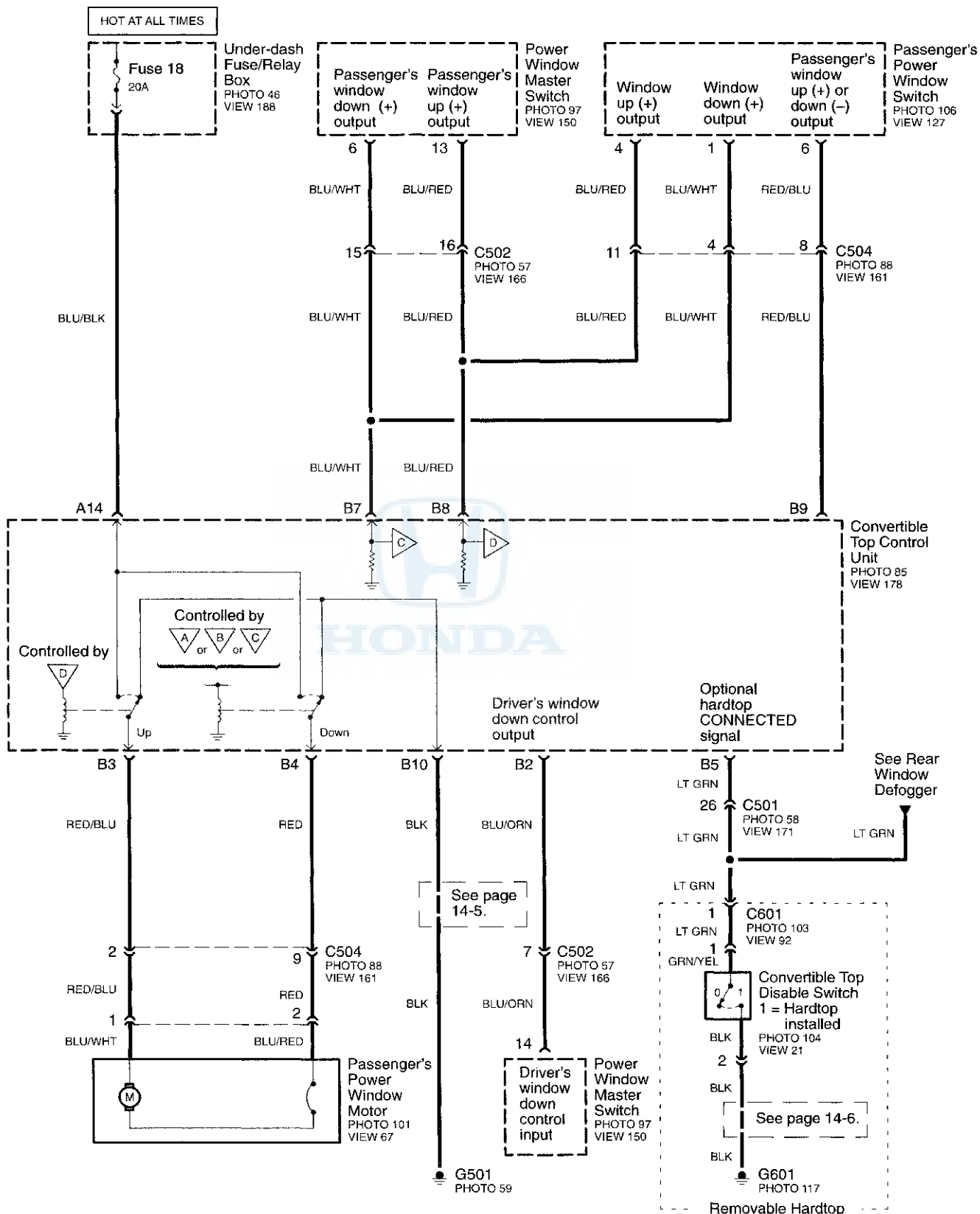

# Power Door Locks/Keyless Entry

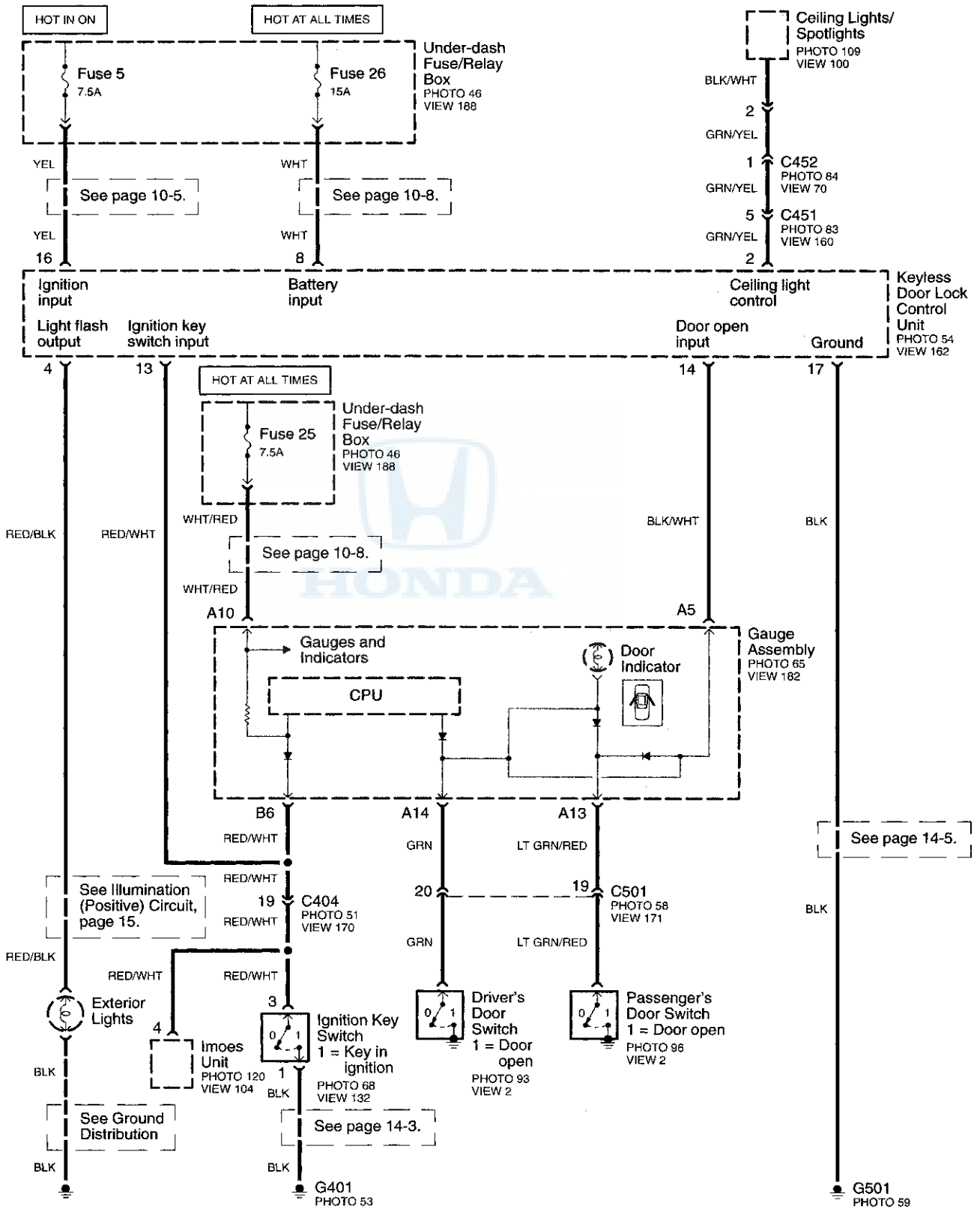

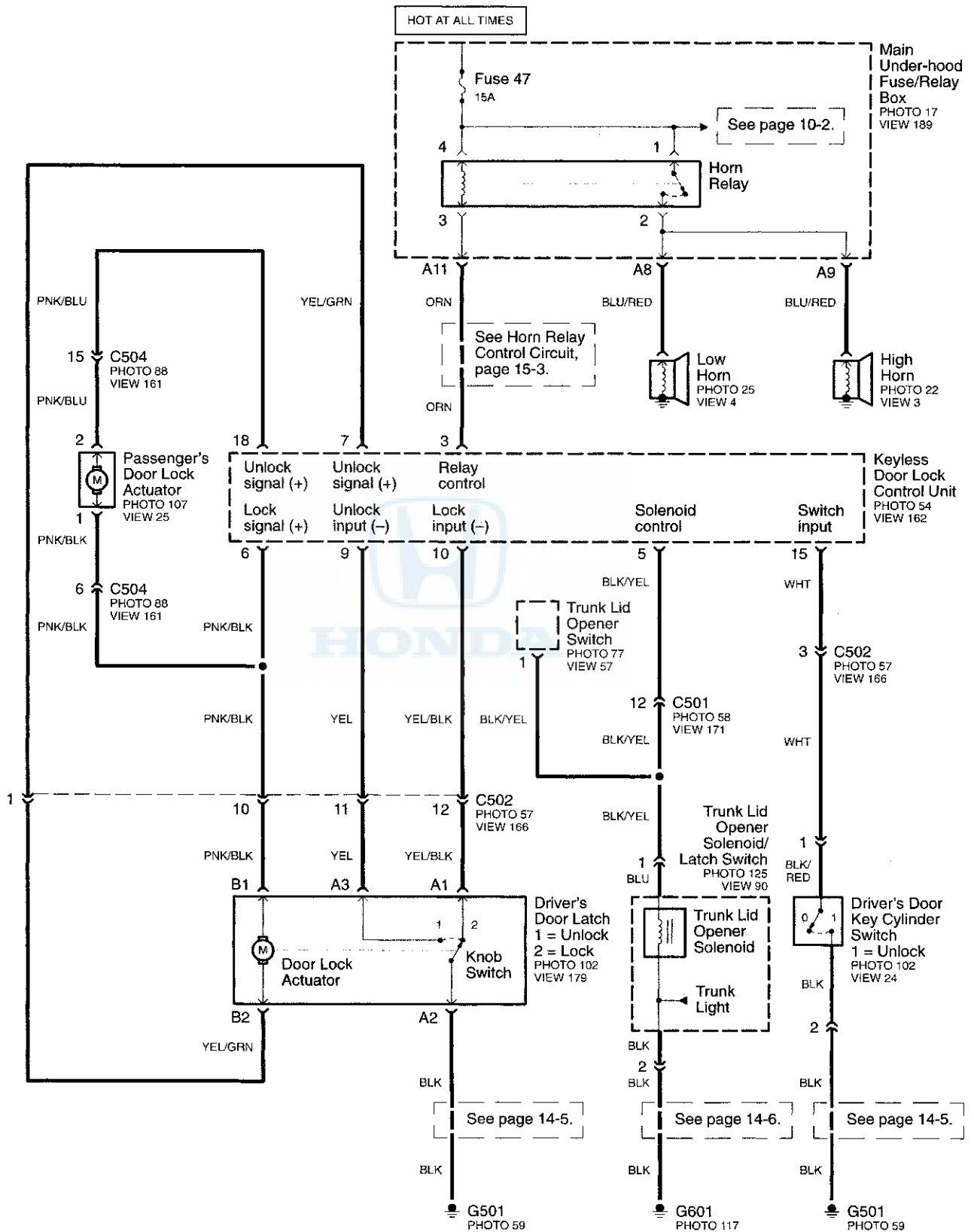
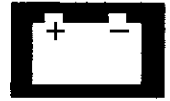



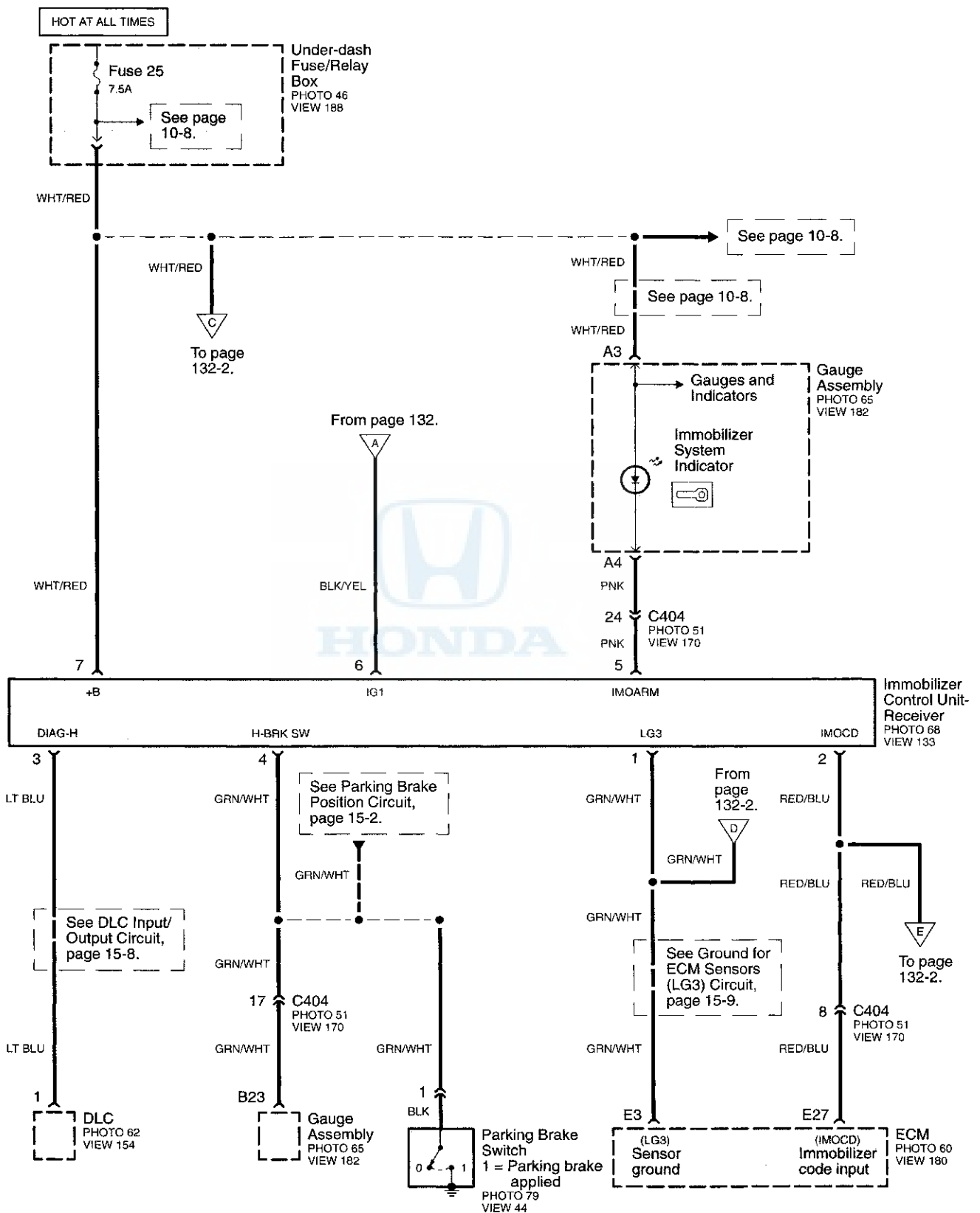

# Immobilizer System

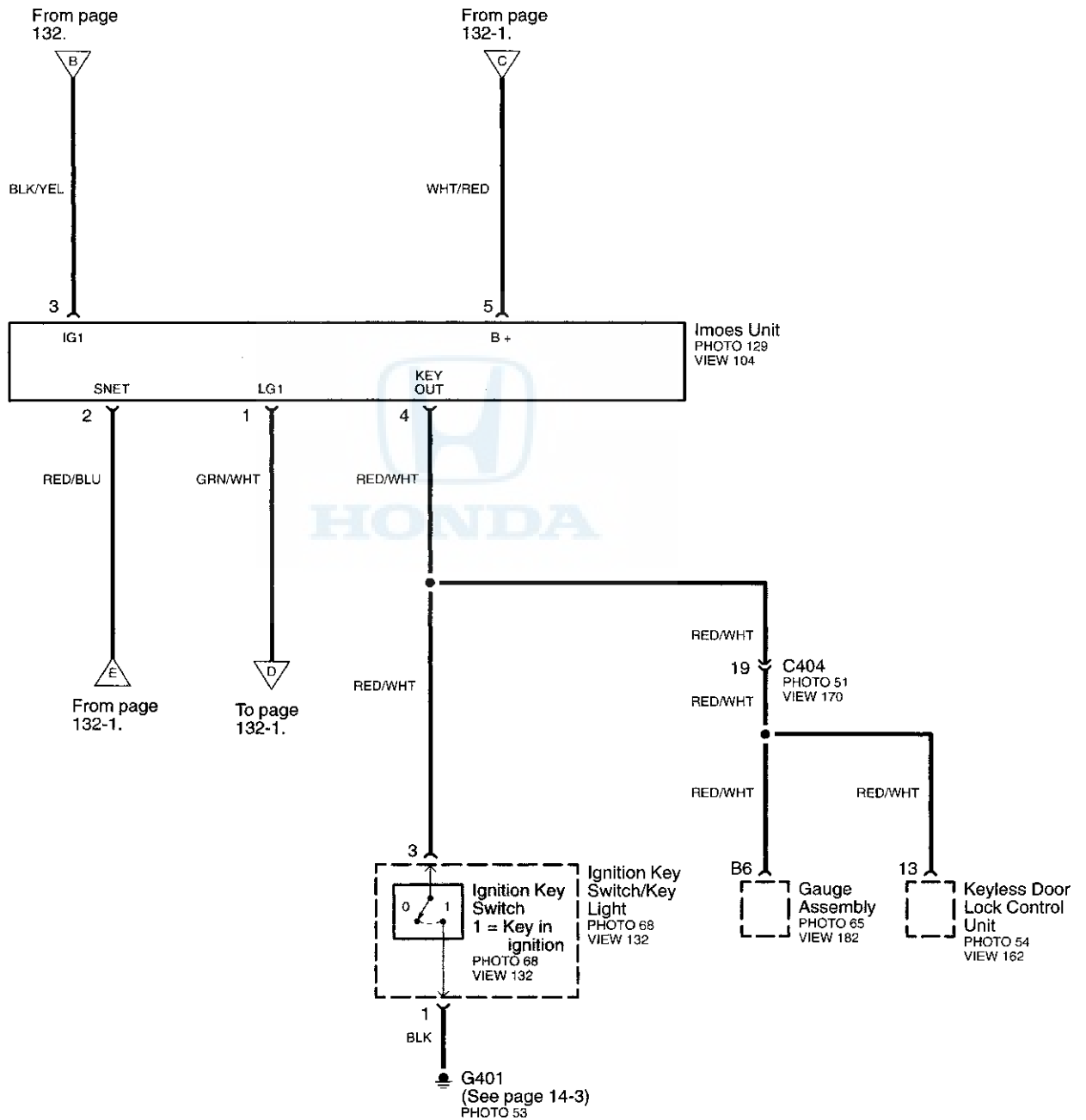

## – How the Circuit Works

---

The immobilizer system is designed to prevent the vehicle from being started without the owner's ignition key. If an attempt is made to start the vehicle with any other key, the immobilizer system will not enable the vehicle's fuel supply system.

The immobilizer system consists of the ignition key, immobilizer control unit-receiver, immobilizer system indicator, PGM-FI main relays, fuel pump, Imoes unit, and the ECM.

Battery voltage is supplied at all times through fuse 25 (in the under-dash fuse/relay box) to the immobilizer control unit-receiver, and to the Imoes unit. With the ignition switch in ON (II), the immobilizer control unit-receiver, Imoes unit and the ECM receive battery voltage through fuse 2 (in the under-dash fuse/relay box).

The ignition key transponder examines the ignition key, then sends a coded signal back to the ECM through the immobilizer control unit-receiver, and Imoes unit. If the ignition key signal is correct, the ECM will enable the vehicle's fuel supply system by grounding the PGM-FI main relay 2. The immobilizer system indicator flashes a code to indicate that a correct ignition key has been inserted. If the ignition key signal is not correct, the ECM will not ground the PGM-FI main relay 2, which will not enable the vehicle's fuel supply system. The immobilizer system indicator then flashes a code to indicate that an incorrect ignition key has been inserted.

Refer to the Service Manual (Section 22, Body Electrical) for specific tests and troubleshooting procedures.

# Security System

## - Honda Accessory

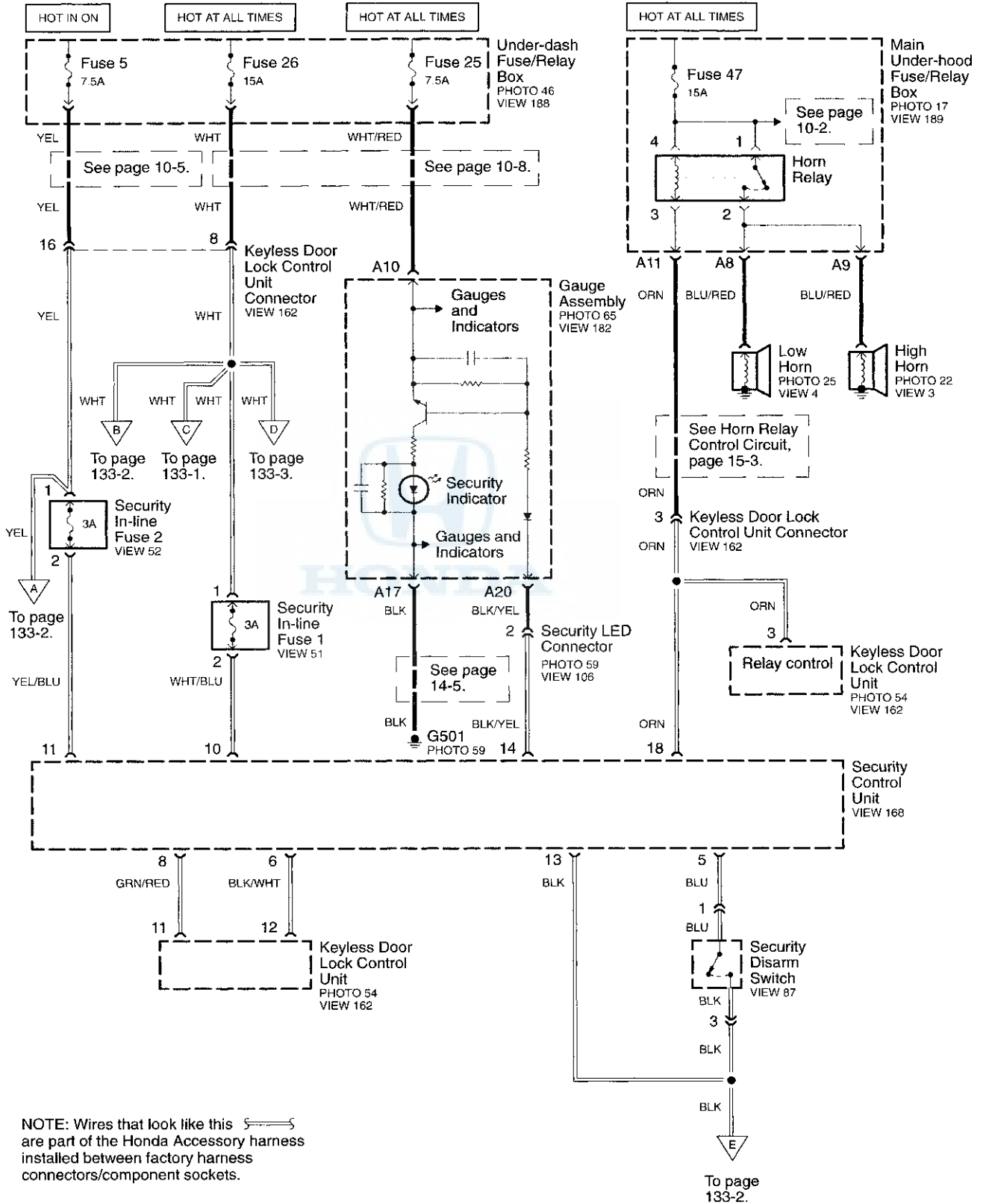



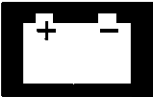

NOTE: Wires that look like this  are part of the Honda Accessory harness installed between factory harness connectors/component sockets.

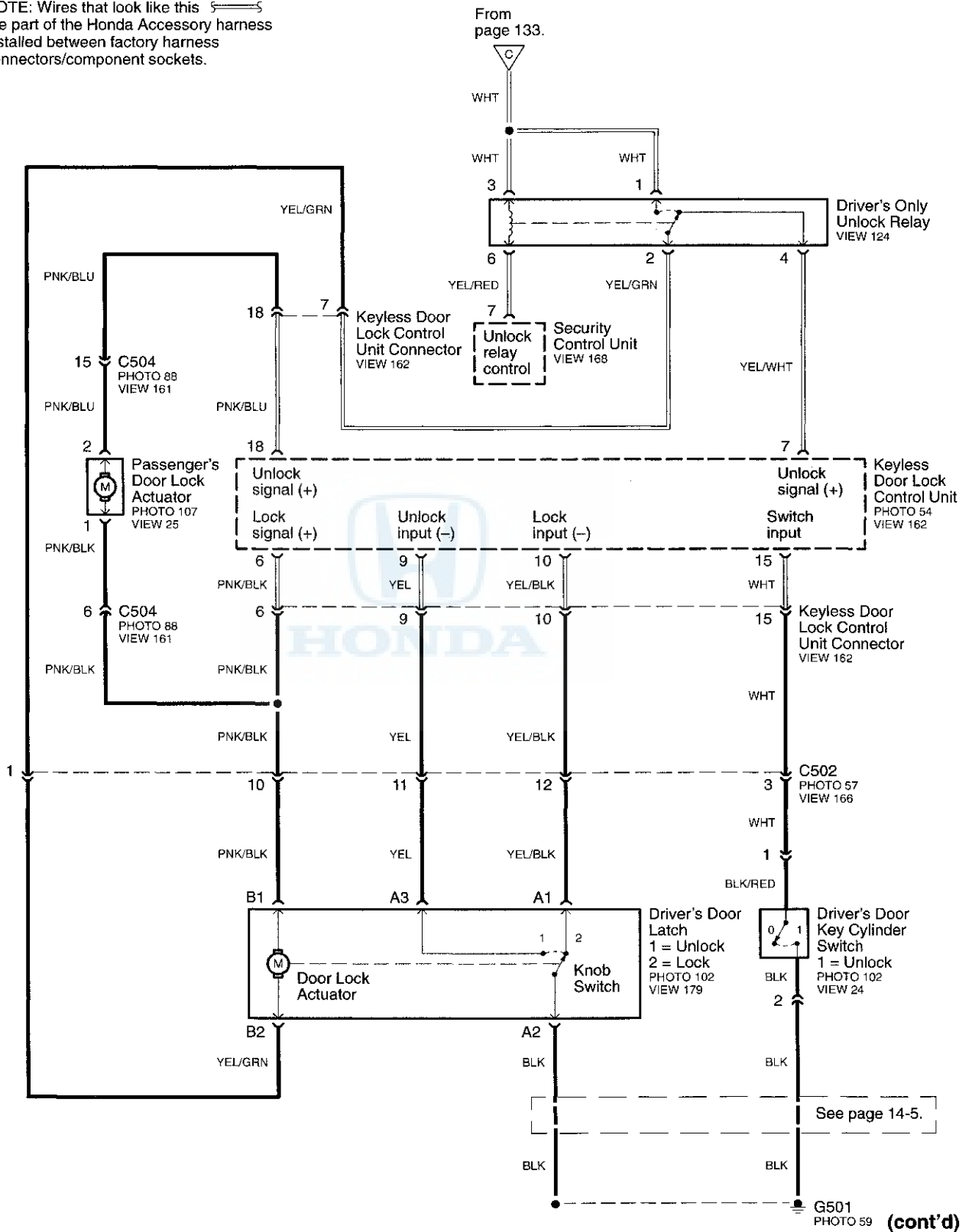

# Security System

## - Honda Accessory

NOTE: Wires that look like this  are part of the Honda Accessory harness installed between factory harness connectors/ component sockets.

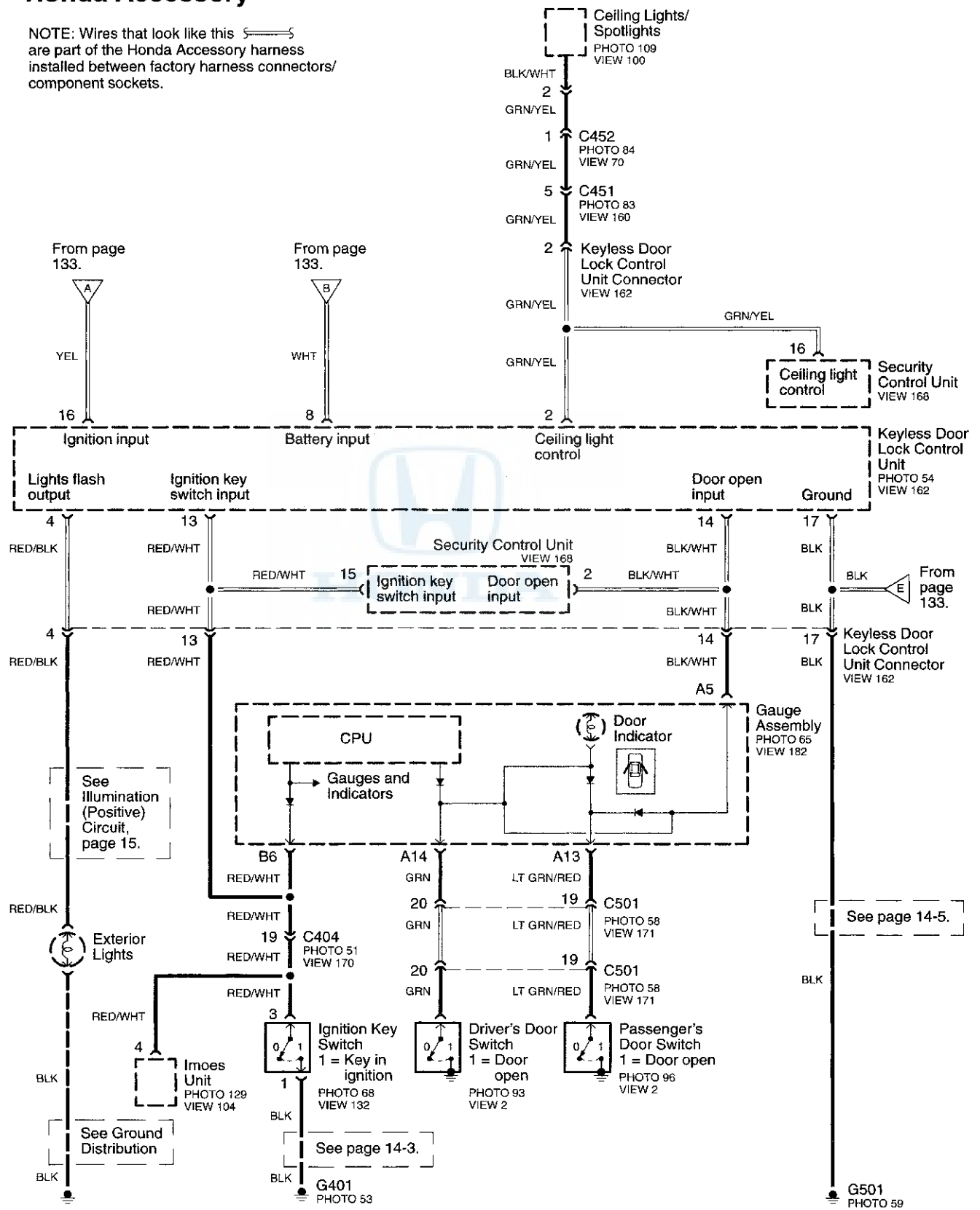

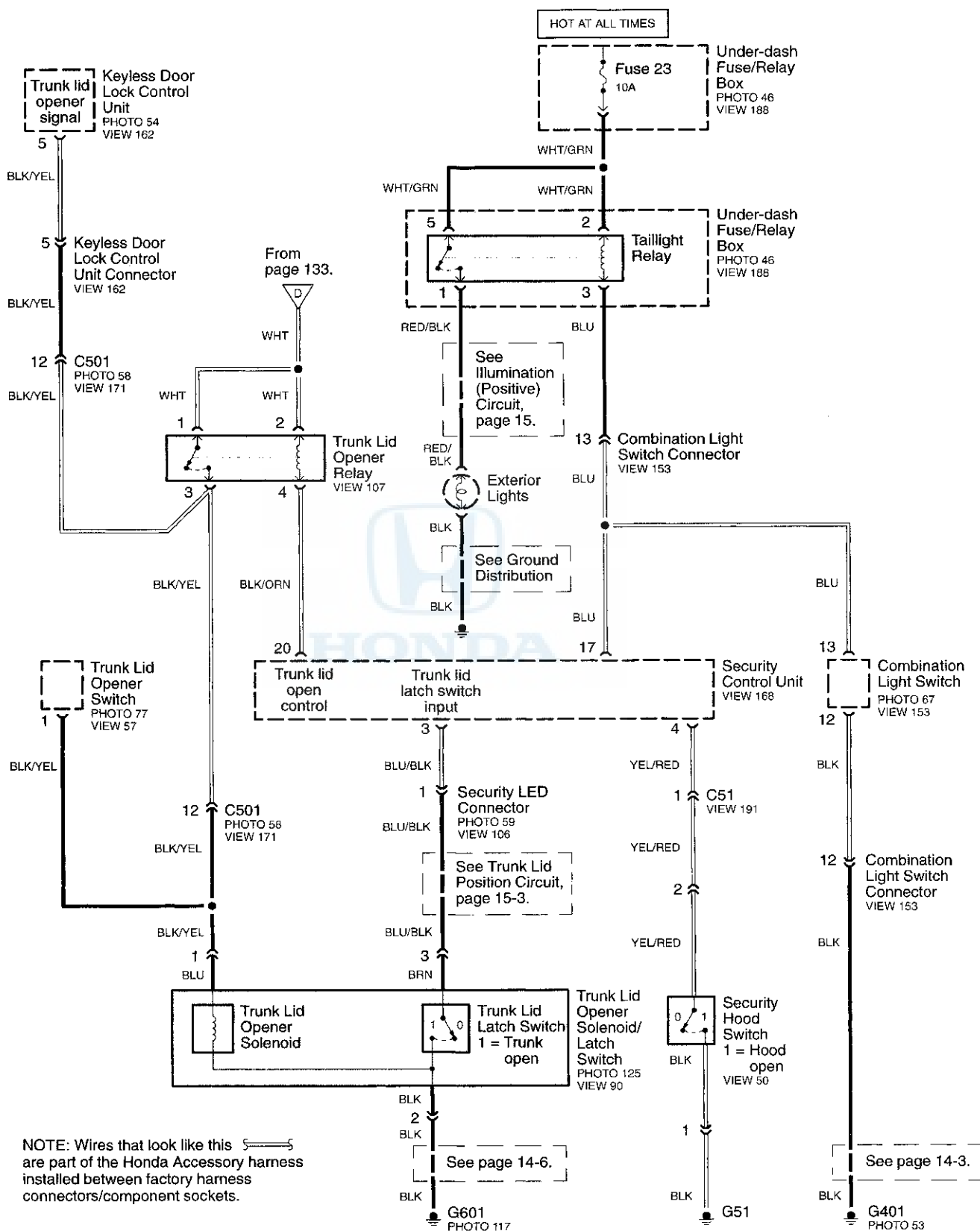

# Trunk Lid Opener

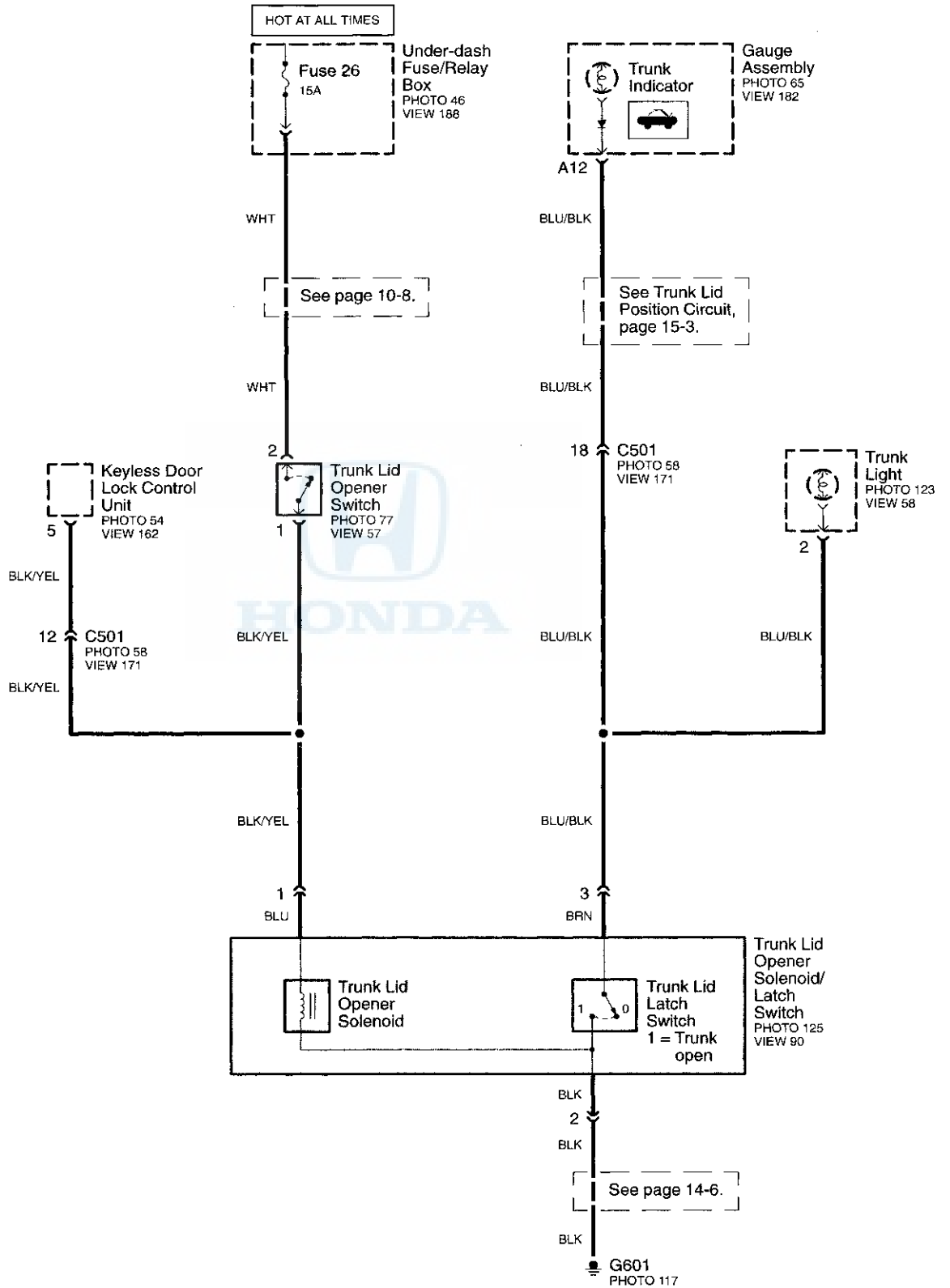



# Power Mirrors

NOTE: See page 10-4 for details of Fuse 19.

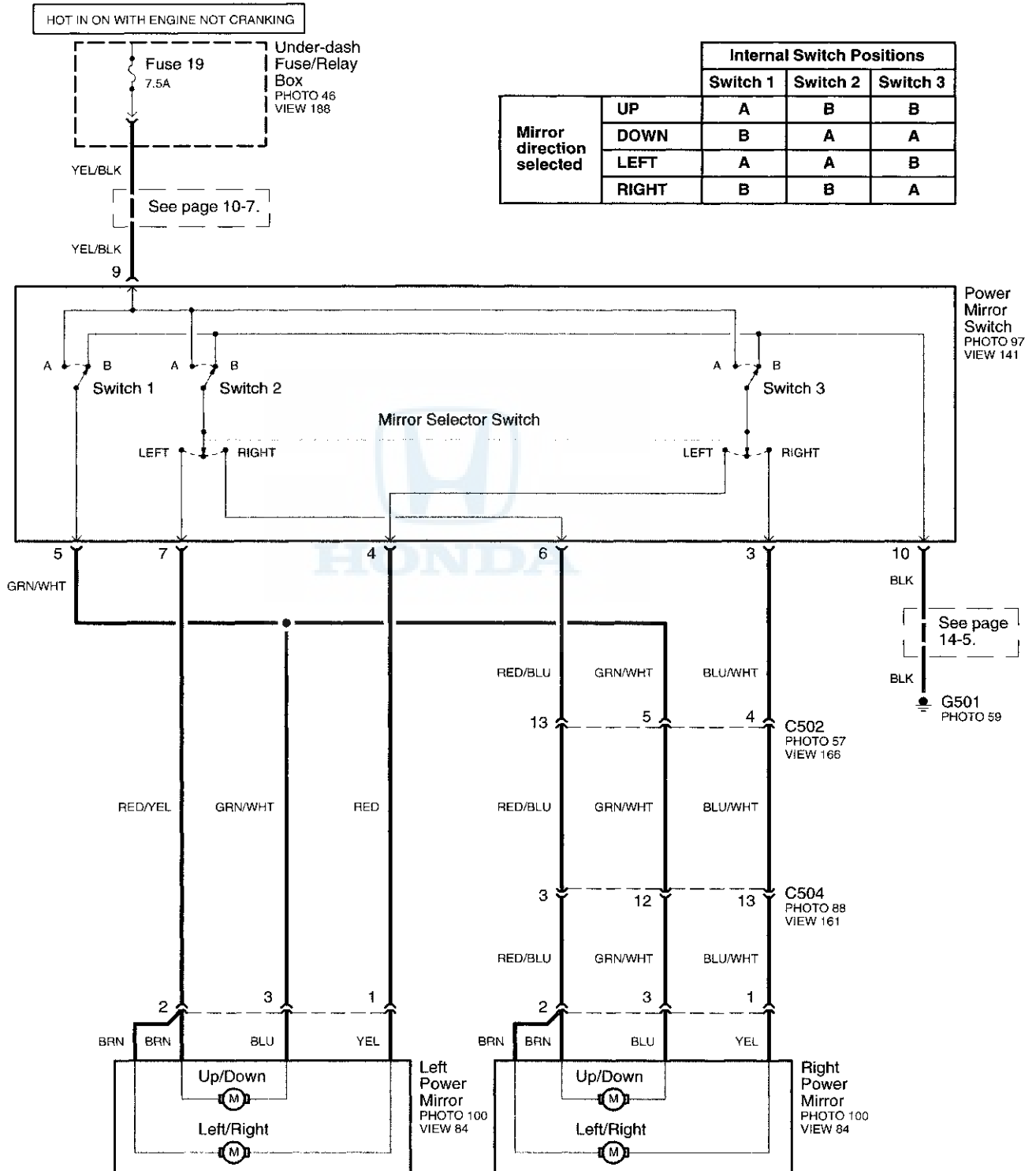



## - How the Circuit Works

The two outside mirrors are controlled by the power mirror switch. Each mirror has two reversible motors: one motor moves the mirror up and down, and the other motor moves the mirror left and right.

The power mirror switch contains three switches to control mirror direction and two switches to select the left or right mirror. With the ignition switch in ON (II) and the engine not cranking, battery voltage is supplied to the power mirror switch through fuse 19 (in the under-dash fuse/relay box). The mirror selector switch directs voltage from two of the direction switches to either the left or the right mirror. Each direction switch is used for more than one function.

### Mirror Up

With the power mirror switch in the up position, switch 1 is moved to the A position. Switch 1 applies battery voltage to both the left and right power mirror up/down motors. If the mirror selector switch is in the left position, the left up/down motor is grounded through the mirror selector switch and switch 2 in the B position to G501. If the right mirror up/down motor is selected, it is also grounded through switch 2 in the B position.

### Mirror Down

With the power mirror switch in the down position, switches 2 and 3 are moved to the A position. Switch 2 applies battery voltage to the left or right power mirror up/down motor as determined by the mirror selector switch. The selected mirror motor is grounded through switch 1 in the B position to G501. When switch 2 is moved to position A, it also applies battery voltage to the selected mirror left/right motor. With switch 3 in the A position, battery voltage is supplied to both sides of the left/right motor, so it does not move.

### Mirror Left

With the power mirror switch in the left position, switches 1 and 2 are moved to the A position. Switch 2 applies battery voltage to the left or right power mirror left/right motor as determined by the mirror selector switch. The selected mirror motor is grounded through switch 3 in the B position to G501. When switch 2 is moved to position A, it also applies battery voltage to the selected mirror up/down motor. With switch 1 in the A position, battery voltage is supplied to both sides of the up/down motor, so it does not move.

### Mirror Right

With the power mirror switch in the right position, switch 3 is moved to the A position. Switch 3 applies battery voltage through the mirror selector switch to the left or right left/right motor. The motor is grounded through the mirror selector switch and switch 2 in the B position to G501.

Refer to the Service Manual (Section 22, Electrical) for specific tests or troubleshooting procedures.

HONDA

# Audio System

- USA: Base, CR Audio - A/C; Canada

NOTE: ACC Cut Relay opens while engine is cranking.

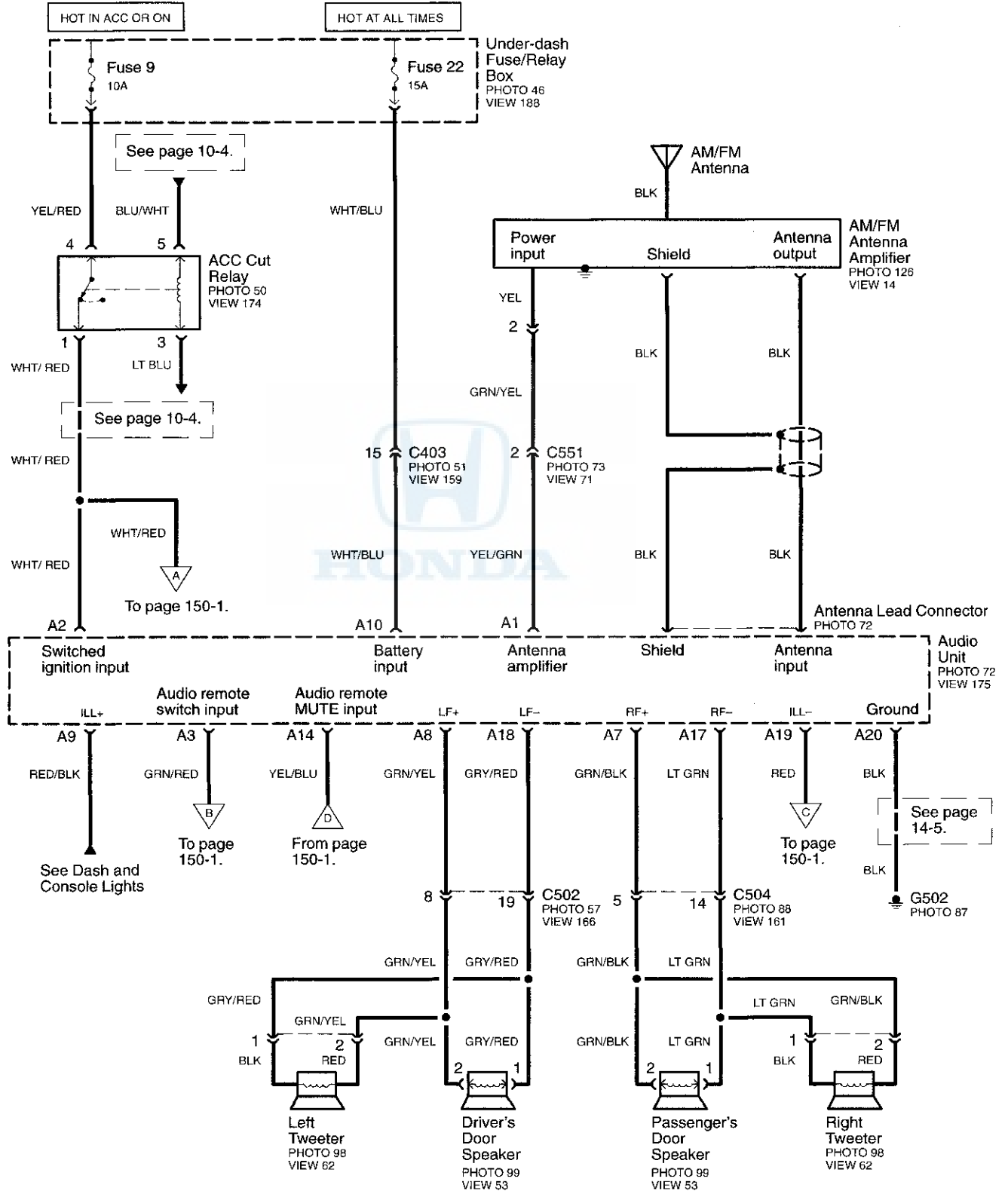



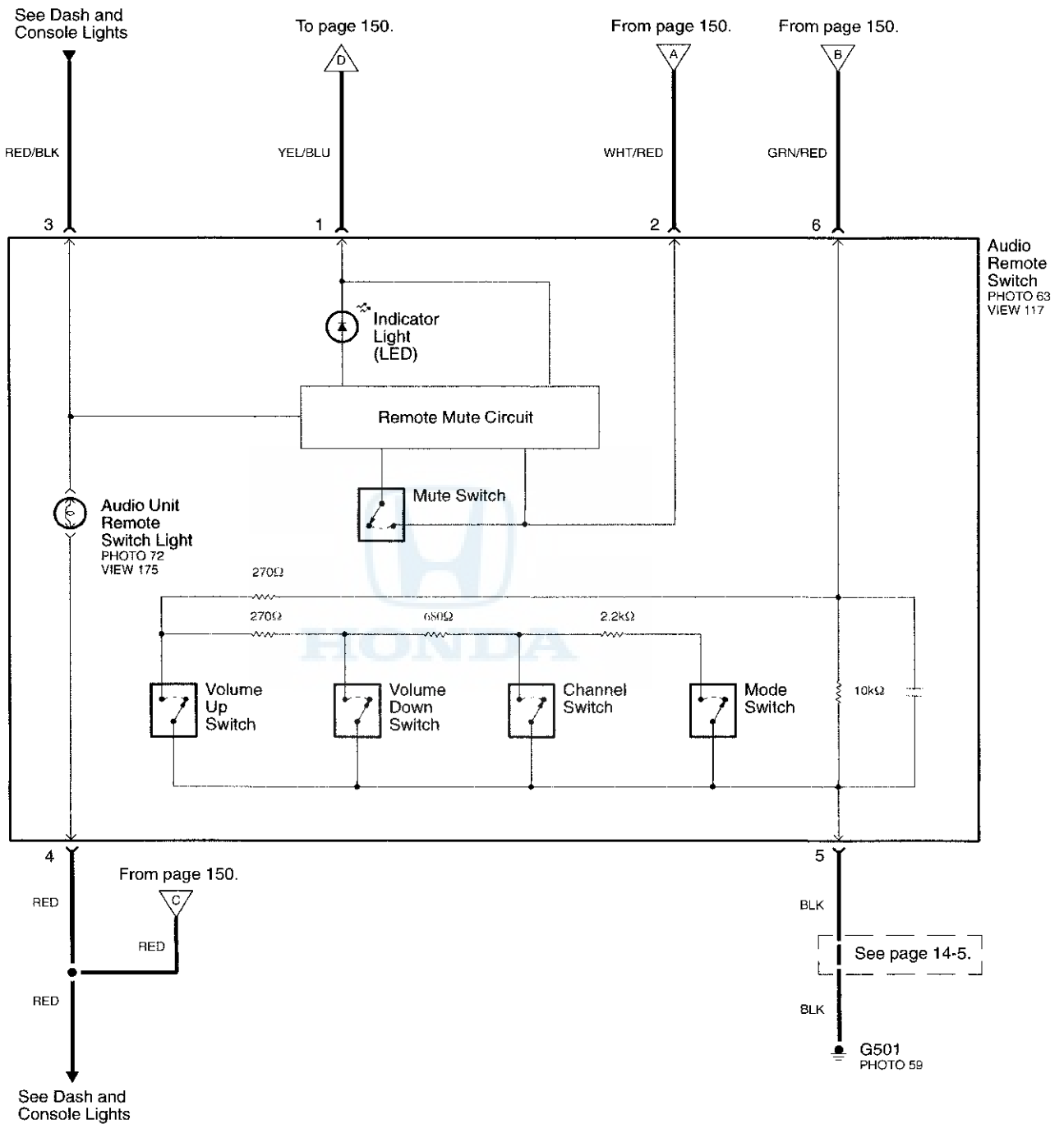

(cont'd)

# Audio System

– USA: Base, CR Audio – A/C; Canada (cont'd)

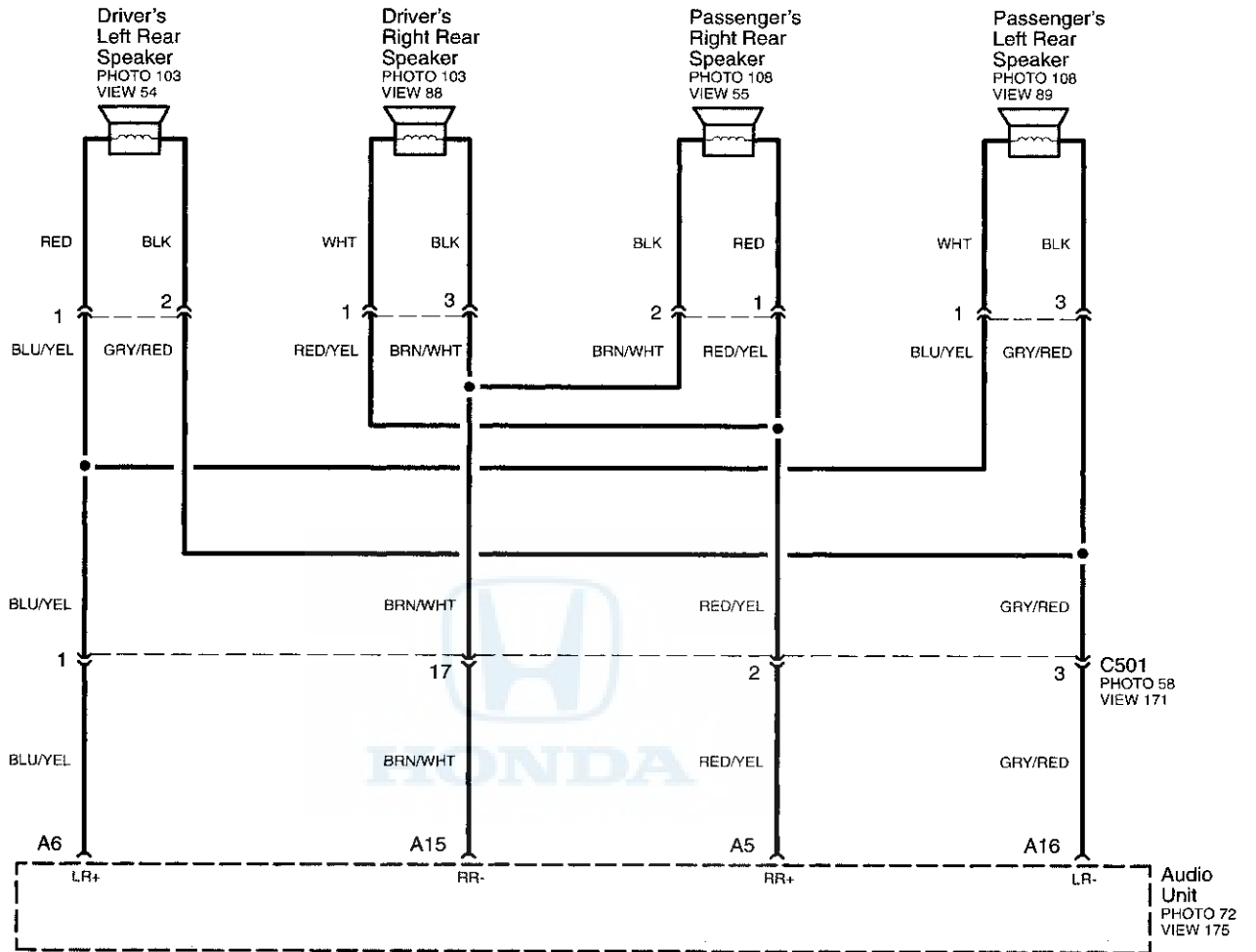

(cont'd on page 150-3 (CD Changer) or page 150-4 (XM Radio))



# - Honda Accessory (cont'd from page 150-2)

## CD Changer (Canada)

NOTE: Wires that look like this  are part of the Honda Accessory harness installed between factory harness connectors/component sockets.

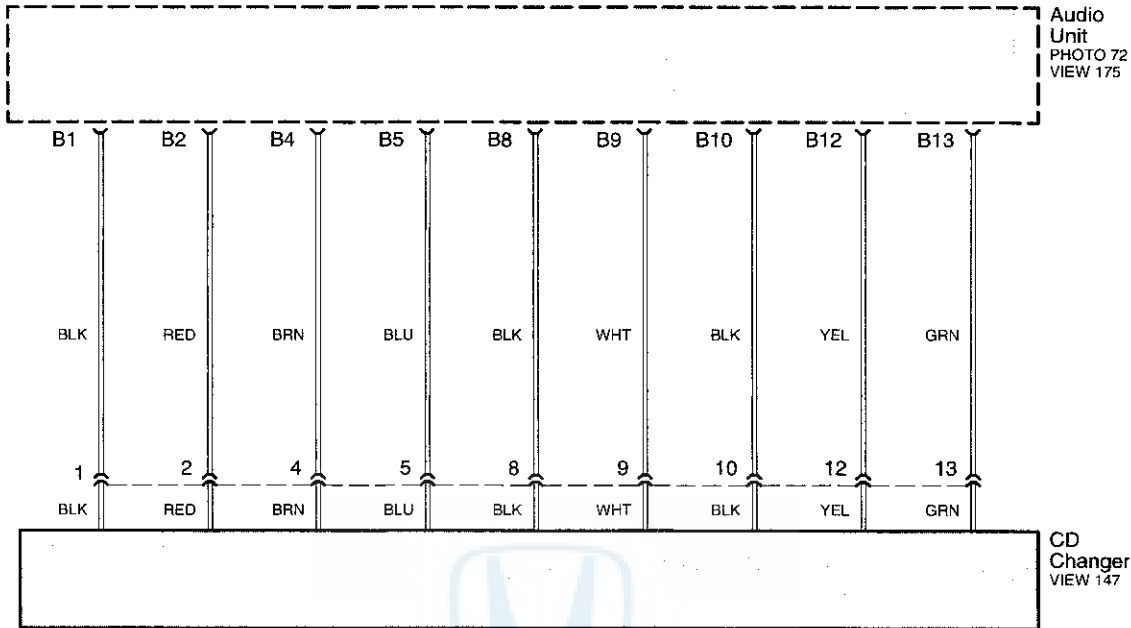

## CD Changer (USA)

See XM Radio, page 150-4.

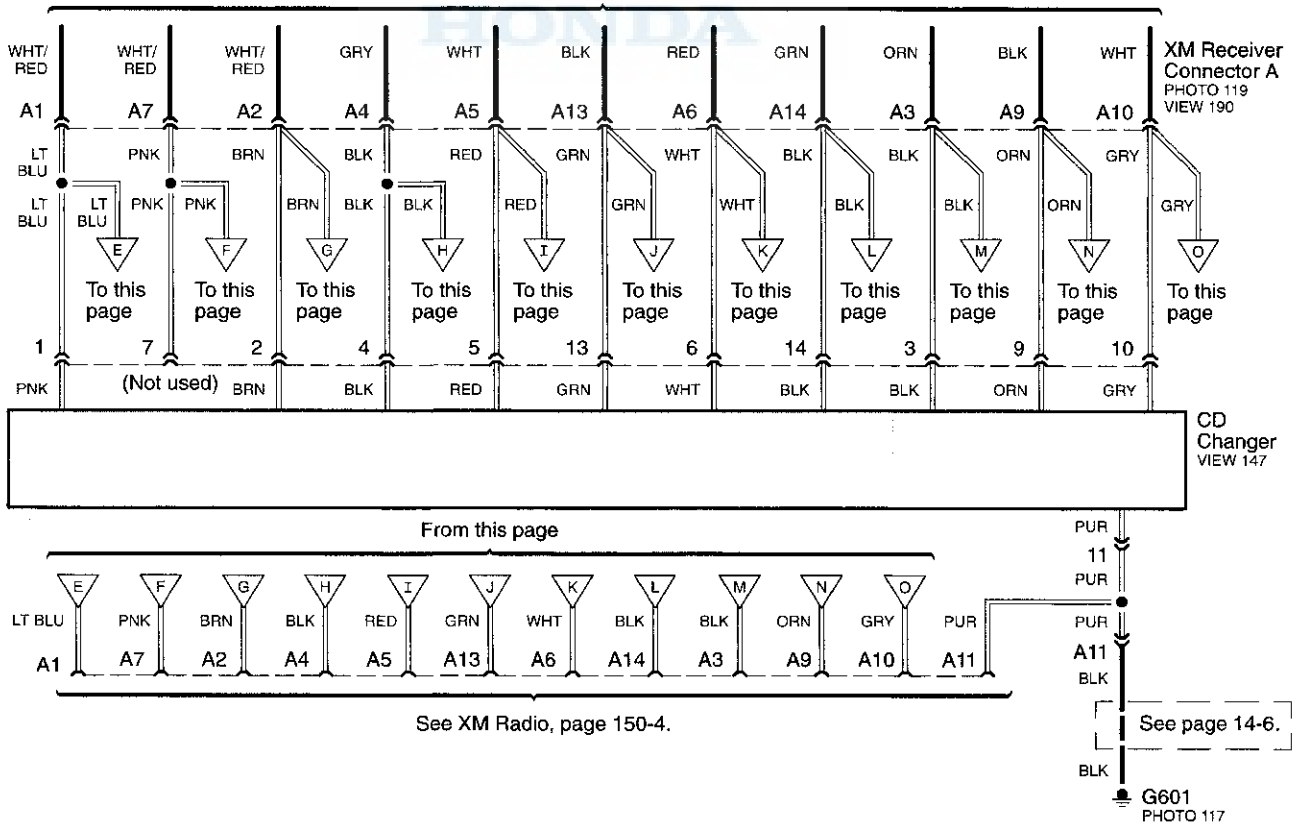



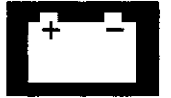

# Accessory Power Socket

- USA: Base; Canada

NOTE: ACC Cut Relay opens while engine is cranking

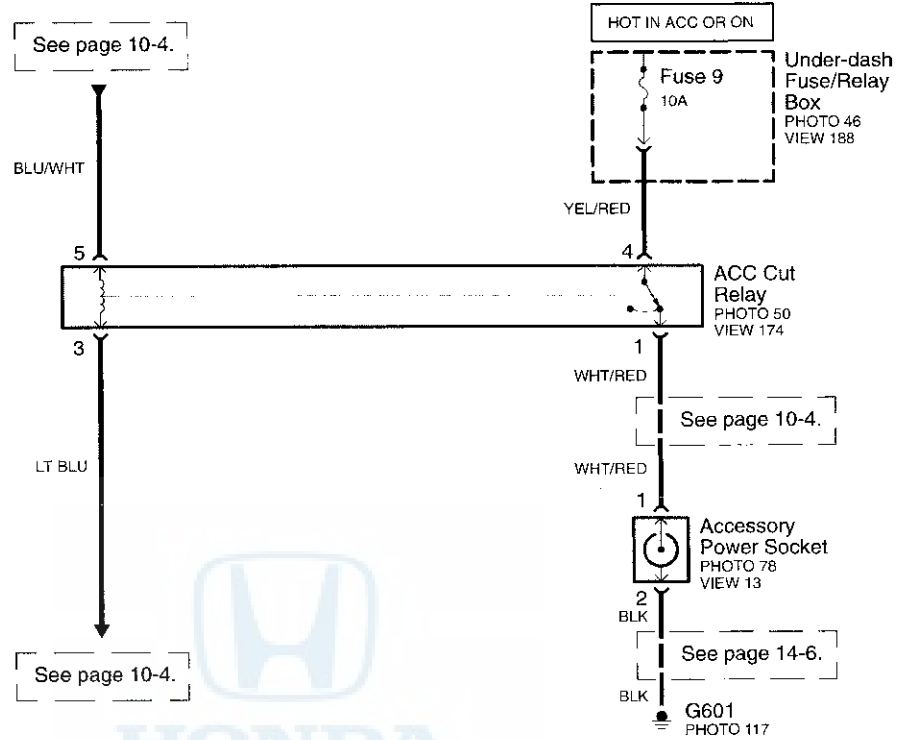



- USA: CR, CR Audio - A/C

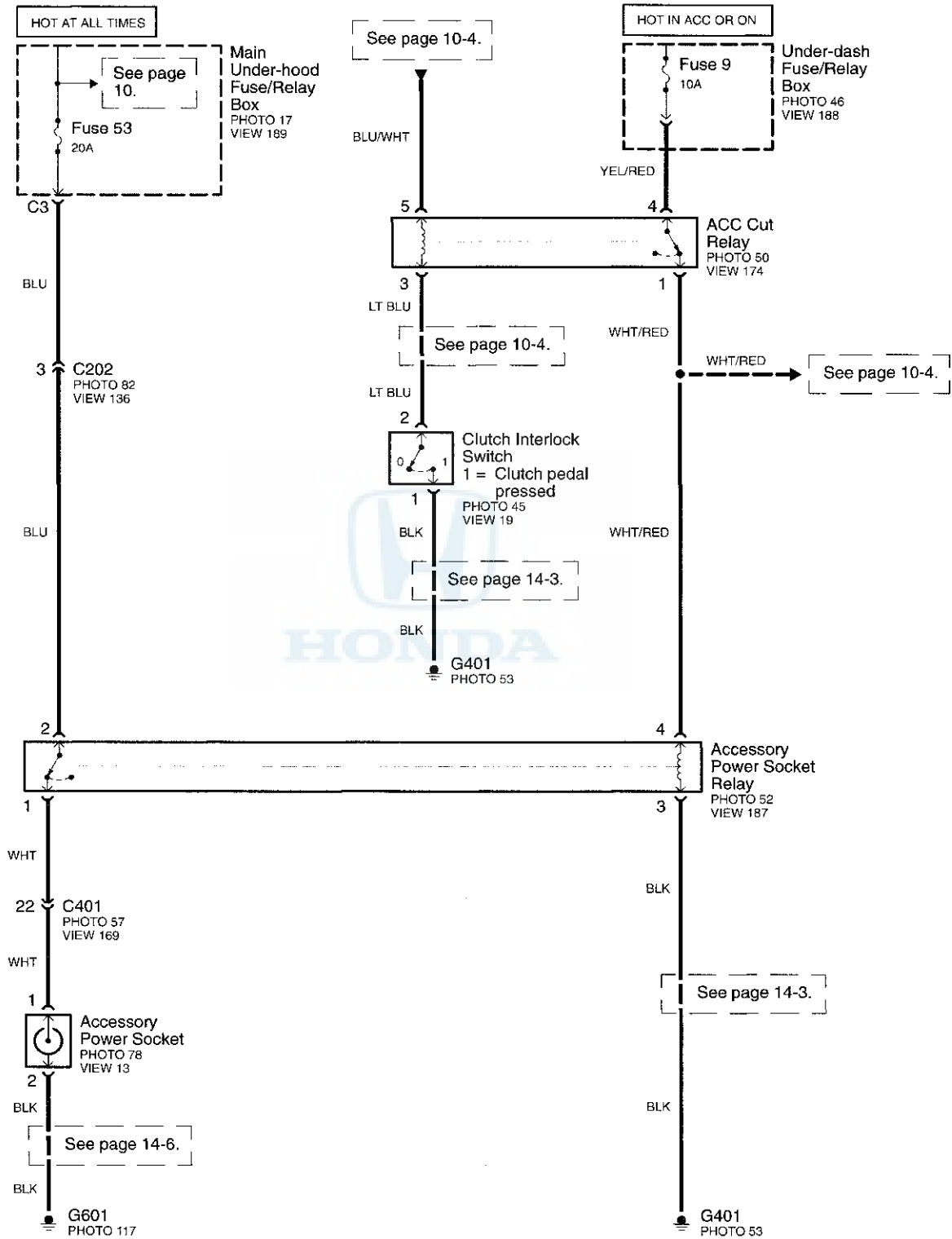

# Connector Index

## How to Use this Index

The Connector Index can help you find the following info about a connector:

- **Location in the Vehicle:** Section 201, Connector Locations, contains photos of all the connectors, in their installed positions on the vehicle.
- **Identification of Terminals:** Section 202, Connector Terminal Views, contains the end view of each connector and its terminals. It also describes the function of each wire in the connector. (The Honda pattern for numbering terminals is explained in the next column.)
- **Location on a Harness:** Section 203, Connector-to-Harness Locations, contains drawings of the vehicle that show where each wiring harness is routed. Connectors on the harness are identified with "ref" numbers and listed in a table for each harness. Each "Ref" row in the table describes the connector, its location, and any harness (or ground) it connects to.
- **Terminal Replacement:** Section 204, Terminal Replacement Procedures, contains instructions covering how to install new terminals, pigtail terminals and how to check for poorly fitting terminals.

## How to Identify Connector Terminals

Connector terminals are numbered according to the cavities they are in. The cavities are numbered starting from the upper left, looking at the male terminals from the terminal side or looking at the female terminals from the wire side. Both views are in the same direction so the numbers are the same. All actual cavities are numbered, even if they have no wire terminals in them.

NOTE: Data Link Connector (DLC) terminals are numbered according to SAE standard J1962, not the Honda standard. The numbers of the four end terminals are molded into the corners of the connector face.

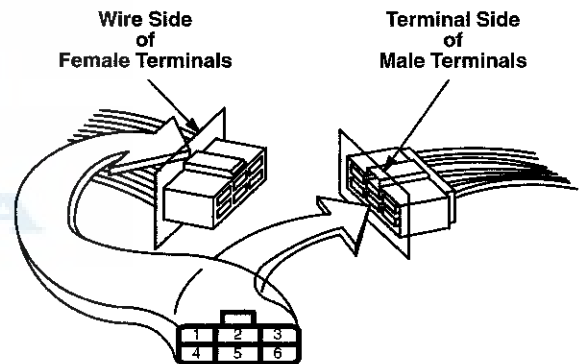

The connector cavity number is listed next to each terminal on the circuit schematic. The cavity / terminal shown below is #6.

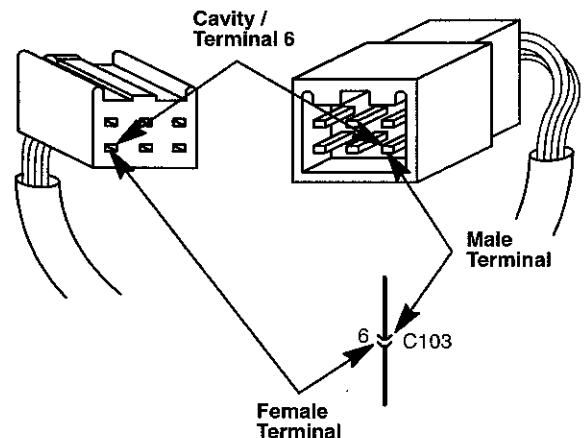





Connector	Location Photo number in Section 201	Terminals View number in Section 202	Harness Page number / table Ref number in Section 203
<b>Ring Terminals</b>			
G1	21		0 / 4
G2	30		0 / 12
G3	6		0 / 5
G4	26		0 / 14
G51 (Honda Accessory)			
G101	38		2 / 8
G201	23		4 / 8
G301	10		6 / 2
G303	1		6 / 11
G351	20		0 / 3
G401	53		8 / 6
G402	84		10 / 20
G501	59		12 / 36
G502	87		12 / 35
G601	117		14 / 21
G602	116		15 / 13
G801	75		17 / 13
G901 (Removable Hardtop) (USA: CR, CR Audio-A/C)	110		20 / 6
G902 (Removable Hardtop) (USA: CR, CR Audio-A/C)	111		20 / 1
T1	18		0 / 1
T2	31		0 / 9
T3	30		0 / 11
T4	26		0 / 13
T5	30		0 / 10
T6	3		0 / 7
T7	3		0 / 6
T101	18		2 / 1
T102	27		2 / 25
T103	39		2 / 33
<b>In-line Connectors</b>			
C51 (Honda Accessory)		191	
C101	56	156	2 / 14 and 12 / 4
C102	56	128	2 / 13 and 12 / 5
C103	56	146	2 / 17 and 12 / 6
C104 (Junction Connector)	55	163	2 / 18

# Connector Index

Connector	Location Photo number in Section 201	Terminals View number in Section 202	Harness Page number / table Ref number in Section 203
<b>In-line Connectors (cont'd)</b>			
C105	34	91	2 / 28
C201	83	157	4 / 23 and 10 / 17
C202	82	136	4 / 24 and 10 / 23
C203	82	137	4 / 22 and 10 / 16
C204	82	164	4 / 21 and 12 / 25
C205	81	109	4 / 25 and 17 / 9
C301	43	152	6 / 16 and 8 / 14
C302	43	158	6 / 20 and 8 / 15
C303	51	165	6 / 19 and 12 / 32
C304	47	138	6 / 17 and 12 / 31
C305	47	110	6 / 18 and 17 / 14
C351	1	69	0 / 8 and 6 / 23
C401	57	169	8 / 5 and 14 / 1
C402	51	129	8 / 19 and 12 / 33
C403	51	159	8 / 18 and 12 / 14
C404	51	170	8 / 17 and 12 / 15
C405 (Junction Connector)	53	142	8 / 7
C451	83	160	10 / 18 and 12 / 24
C452	84	70	10 / 21 and 16 / 2
C453	82	143	10 / 15 and 12 / 22
C501	58	171	12 / 2 and 14 / 2
C502	57	166	12 / 3 and 18 / 2
C503	47	130	12 / 34 and 17 / 4
C504	88	161	12 / 26 and 19 / 1
C505	58	144	12 / 1 and 14 / 29
C507 (Junction Connector)	129	145	
C551 (USA: Base, CR Audio-A/C; Canada)	73	71	12 / 21 and 16 / 3
C601	103	92	14 / 6 and 20 / 3
C602 (Softtop) (USA: Base; Canada)	120	72	14 / 13 and 21 / 3
C603	95	139	14 / 23 and 17 / 11
C650	113	192	14 / 28
C701	66	93	
C901 (Removable Hardtop)	94	94	20 / 7 and 20 / 8



<b>Connector</b>	<b>Location</b> Photo number in <b>Section 201</b>	<b>Terminals</b> View number in <b>Section 202</b>	<b>Harness</b> Page number / table Ref number in <b>Section 203</b>
<b>Component Connectors</b>			
A/C Compressor (USA: Base, CR Audio – A/C; Canada)	29	1	2 / 23
A/C Condenser Fan Motor (USA: Base, CR Audio – A/C; Canada)	10	11	4 / 1
A/C Pressure Switch (USA: Base, CR Audio – A/C; Canada)	25	12	4 / 4
ACC Cut Relay	50	174	10 / 30
A/F Sensor	42	95	2 / 9
A/F Sensor Relay	49	103	10 / 2
Accessory Power Socket	78	13	15 / 6
Accessory Power Socket Relay	52	187	8 / 8
Air Mix Control Motor	87	131	10 / 9
Airbag First and Second Inflators Driver's Passenger's	66 87	96 97	17 / 8
Alternator	27	98	2 / 24
AM/FM Antenna Amplifier	126	14	16 / 4
Antenna Lead Connector	72		
APP Sensor	6	116	6 / 9
Audio Remote Switch (USA: Base, CR Audio – A/C; Canada)	63	117	12 / 10
Audio Unit (USA: Base, CR Audio – A/C; Canada) Connector A Connector B	72	175	12 / 20 12 / 29
Back-up Light Switch	41	16	2 / 10
Back-up Light Left Right	122	15	14 / 16 15 / 11
Blower Motor	90	17	10 / 13
Blower Power Transistor	86	111	10 / 11
Brake Fluid Level Switch	5	18	6 / 15
Brake Pedal Position Switch	45	99	8 / 16
Brake/Side Marker/Taillight Left Right	122	73	14 / 14 15 / 9
Cable Reel Connector A Connector B	70 69	177	17 / 5 8 / 21
CD Changer (Honda Accessory)		147	
Ceiling Light/Spotlights	109	100	16 / 1

# Connector Index

Connector	Location Photo number in Section 201	Terminals View number in Section 202	Harness Page number / table Ref number in Section 203
<b>Component Connectors (cont'd)</b>			
CKP Sensor	40	74	2 / 29
Clutch Interlock Switch	45	19	8 / 13
Clutch Pedal Position Switch	45	20	8 / 12
CMP Sensor	35	75	2 / 6
Combination Light Switch	67	153	8 / 20
Convertible Top Control Unit (USA: Base; Canada) Connector A Connector B	85	178	10 / 12 12 / 23
Convertible Top Disable Switch (Removable Hardtop) (USA: CR, CR Audio – A/C)	104	21	20 / 5
Convertible Top Motor (USA: Base; Canada) Left Right	93 96	23	14 / 5 15 / 5
Convertible Top Motor Emergency Connector (USA: Base; Canada)	89	22	10 / 22
Convertible Top Switch (USA: Base; Canada)	76	118	10 / 27
Cruise Control Main Switch	63	119	12 / 13
Cruise Control Set/Resume/Cancel Switch	66	101	
DLC	62	154	10 / 28
Door Key Cylinder Switch, Driver's	102	24	18 / 7
Door Latch, Driver's Connector A Connector B	102	179	18 / 9 18 / 8
Door Lock Actuator, Passenger's	107	25	19 / 6
Door Switch Driver's Passenger's	93 96	2	14 / 4 15 / 4
Driver's Seat Position Sensor	113	26	14 / 28
DRL Control Unit	44	148	10 / 6
DRL Diode 1 2 (USA)	80	27 76	10 / 5 10 / 4
DRL Sub-control Unit (USA)	44	149	10 / 7
ECM Connector A Connector B Connector D Connector E	60	180	2 / 15 2 / 16 12 / 11 12 / 12



Connector	Location Photo number in Section 201	Terminals View number in Section 202	Harness Page number / table Ref number in Section 203
<b>Component Connectors (cont'd)</b>			
ECT Sensor			
1	37	28	2 / 32
2	12	29	6 / 1
ELD Unit	18	77	4 / 16
Engine Start Switch	63	112	12 / 7
EPS Control Unit	19	181	
Connector A			4 / 17
Connector B			4 / 19
Connector C			0 / 2
EPS Motor	26	30	4 / 3
EPS Torque Sensor	11	78	4 / 2
EVAP Canister Purge Valve	8	31	6 / 25
EVAP Canister Vent Shut Valve	91	32	14 / 9
Evaporator Temperature Sensor (USA: Base, CR Audio – A/C; Canada)	86	33	10 / 10
FTP Sensor	92	79	14 / 8
Fuel Tank Unit	124	113	14 / 22
Gauge Assembly	65	182	
Connector A			12 / 17
Connector B			12 / 16
Hazard Warning Switch	76	140	10 / 25
Headlight, High Beam	14	80	
Left			6 / 3
Right			4 / 9
Headlight, Low Beam	14	34	
Left			6 / 4
Right			4 / 10
Heater Control Panel	64	172	12 / 18
High Beam Cut Relay	54	183	8 / 10
High Mount Brake Light	125	35	14 / 18
Horn			
High	22	3	4 / 15
Low	25	4	4 / 6
Horn Switch	66	5	
IAT Sensor	33	36	6 / 26
IG2 Relay	50	174	10 / 29
Ignition Coil Relay	49	103	10 / 1

# Connector Index

Connector	Location Photo number in Section 201	Terminals View number in Section 202	Harness Page number / table Ref number in Section 203
<b>Component Connectors (cont'd)</b>			
Ignition Coils No. 1 No. 2 No. 3 No. 4	36	81	2 / 3 2 / 4 2 / 5 2 / 7
Ignition Key Switch	68	132	8 / 3
Immobilizer Control Unit-Receiver	68	133	8 / 2
Imoes Unit	129	104	10 / 19
Impact Sensor Left Front Right Front	13	37 38	6 / 5 4 / 12
Injectors No. 1 No. 2 No. 3 No. 4	32	39	2 / 30 2 / 27 2 / 31 2 / 19
Intermittent Wiper Relay	2	120	6 / 13
Keyless Door Lock Control Unit (Factory)	54	162	12 / 9
Keyless Door Lock Control Unit Connector (Honda Accessory)		162	12 / 9
Knock Sensor	31	6	2 / 26
License Plate Light	127	40	15 / 12
MAP Sensor	28	82	2 / 22
MES Connector	46	41	17 / 1
Mode Control Motor	61	134	10 / 8
Noise Condenser	121	42	14 / 10
Output Shaft (Countershaft) Speed Sensor	41	83	2 / 12
Outside Air Temperature Sensor	25	43	4 / 5
Parking Brake Switch	79	44	10 / 24
Parking/Side Marker Light Left Front Right Front	15	45	6 / 8 4 / 13
Passenger's Airbag Cut-Off Indicator	71	105	12 / 19
Passenger's Weight Sensor Unit Connector A Connector B Connector C	115	184	15 / 2
PGM-FI Main Relay 1 2	48	185	10 / 3 10 / 31



Connector	Location Photo number in Section 201	Terminals View number in Section 202	Harness Page number / table Ref number in Section 203
<b>Component Connectors (cont'd)</b>			
Power Mirror Left Right	100	84	18 / 1 19 / 2
Power Mirror Switch	97	141	18 / 5
Power Window Master Switch	97	150	18 / 4
Power Window Motor Driver's Passenger's	101	108 67	18 / 6 19 / 5
Power Window Switch, Passenger's	106	127	19 / 4
Radiator Fan Motor	23	46	4 / 7
Rear Window Defogger Removable Hardtop Connector A Connector B Softop (USA: Base; Canada) Connector A Connector B	110  112	7  8	20 / 4 20 / 2 21 / 1 21 / 2
Rear Window Defogger Change Relay (USA: Base; Canada)	120	121	14 / 12
Rear Window Defogger Diode (USA: Base; Canada)	120	47	14 / 11
Rear Window Defogger Relay	52	183	8 / 11
Rear Window Defogger Switch	76	122	10 / 26
Recirculation Control Motor	88	135	10 / 14
Rocker Arm Oil Control Solenoid (VTEC Solenoid Valve)	39	9	2 / 2
Rocker Arm Oil Pressure Switch (VTEC Oil Pressure Switch)	39	48	2 / 34
Seat Belt Buckle Switch Driver's Passenger's	113 114	85 86	14 / 3 15 / 1
Seat Belt Tensioner Driver's Passenger's	105	49	17 / 12 17 / 10
Secondary HO2S	41	102	2 / 11
Security Control Unit (Honda Accessory)		168	
Security Disarm Switch (Honda Accessory)		87	
Security Hood Switch (Honda Accessory)		50	
Security In-line Fuse (Honda Accessory) 1 2		51 52	
Security LED Connector	59	106	12 / 8

# Connector Index

Connector	Location Photo number in Section 201	Terminals View number in Section 202	Harness Page number / table Ref number in Section 203
<b>Component Connectors (cont'd)</b>			
Speaker (USA: Base, CR Audio – A/C; Canada)			
Driver's Door	99	53	18 / 3
Driver's Left Rear	103	54	14 / 26
Driver's Right Rear	103	88	14 / 27
Passenger's Door	99	53	19 / 3
Passenger's Left Rear	108	89	15 / 3
Passenger's Right Rear	108	55	15 / 8
SRS Unit	74	186	
Connector A			17 / 6
Connector B			17 / 7
Starter	31		
Starter Solenoid	31	10	2 / 20
Steering Angle Sensor	67	114	8 / 22
Test Tachometer Connector	1	56	6 / 14
Throttle Actuator Control Module	81	155	12 / 28
Throttle Actuator Control Module Relay	52	187	8 / 9
TPMS Control Unit	128	167	8 / 4
TP Sensor/Throttle Actuator	27	123	2 / 21
Trunk Lid Opener Relay (Honda Accessory)		107	
Trunk Lid Opener Solenoid/Latch Switch	125	90	14 / 17
Trunk Lid Opener Switch	77	57	14 / 24
Trunk Light	123	58	14 / 20
Turn Signal Light			
Left Front	15	59	6 / 6
Left Rear	122	60	14 / 15
Left Side	16	61	6 / 12
Right Front	15	59	4 / 14
Right Rear	122	60	15 / 10
Right Side	16	61	4 / 20
Tweeter (USA: Base, CR Audio – A/C; Canada)	98	62	
Left			18 / 10
Right			19 / 7
Under-dash Fuse/Relay Box		188	
Connector A	46		17 / 2
Connector B	46		17 / 3
Connector C			
Connector D			
Under-hood Fuse Box, Auxiliary	4	176	
Connector A			6 / 22
Connector B			6 / 10





Connector	Location Photo number in Section 201	Terminals View number in Section 202	Harness Page number / table Ref number in Section 203
<b>Component Connectors (cont'd)</b>			
Under-hood Fuse/Relay Box, Main Connector A Connector B Connector C Connector D	17	189	4 / 29 4 / 28 4 / 27 4 / 26
Unlock Relay, Driver's Only (Honda Accessory)		124	
VSA Modulator-Control Unit	7	173	6 / 24
VSA Off Switch	64	125	12 / 30
VSA Sensor Cluster	95	126	14 / 25
Wheel Speed Sensor Left Front Left Rear Right Front Right Rear	10 118 22 118	63 64 65 66	6 / 7 14 / 7 4 / 11 15 / 7
Windshield Washer Motor	24	68	4 / 18
Windshield Wiper Motor	9	115	6 / 21
Wiper/Washer Switch	69	151	8 / 1
XM Receiver (USA) Connector A	119	190	14 / 19

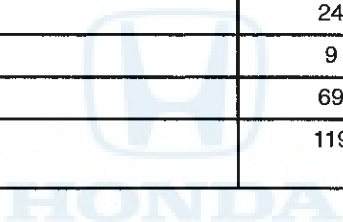

# Component Location

1. Left Side of Engine Compartment

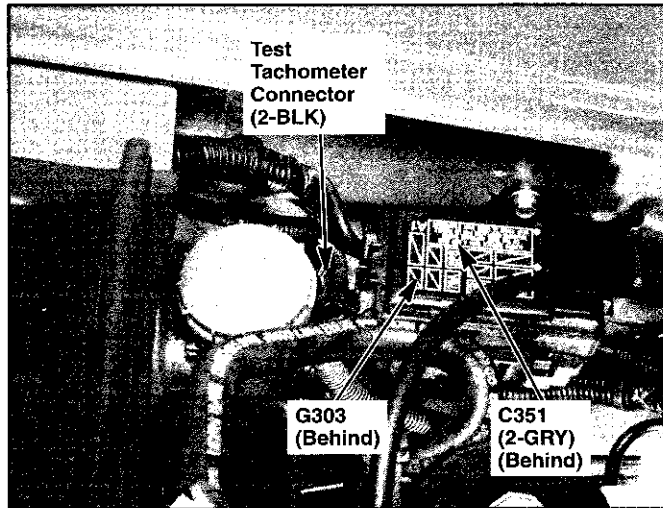

4. Left Side of Engine Compartment

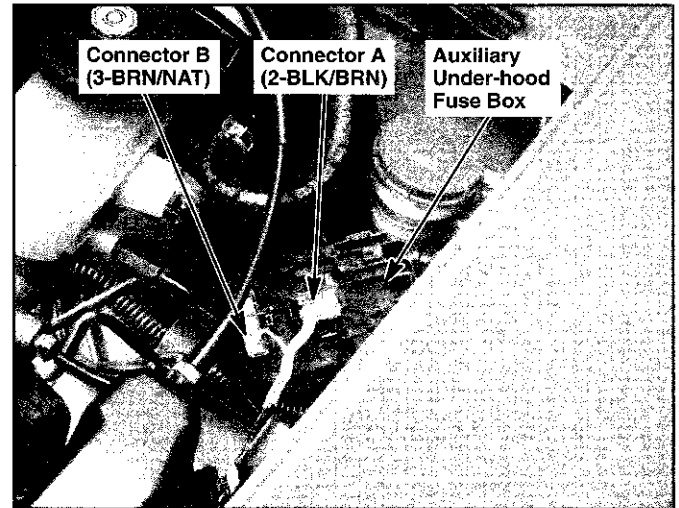

2. Left Side of Engine Compartment

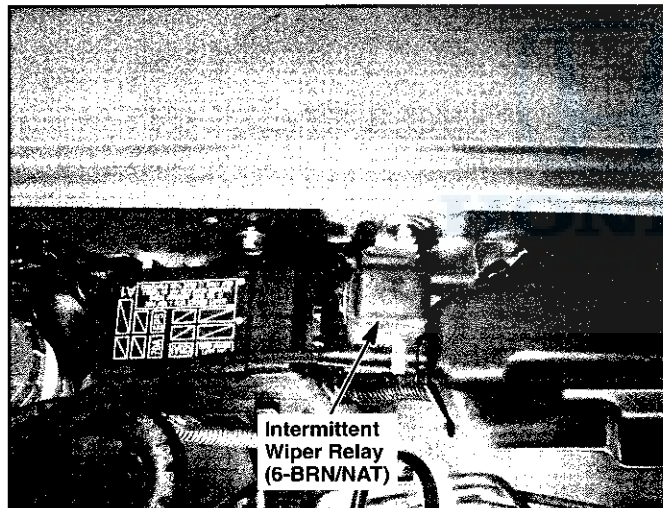

5. Left Side of Engine Compartment

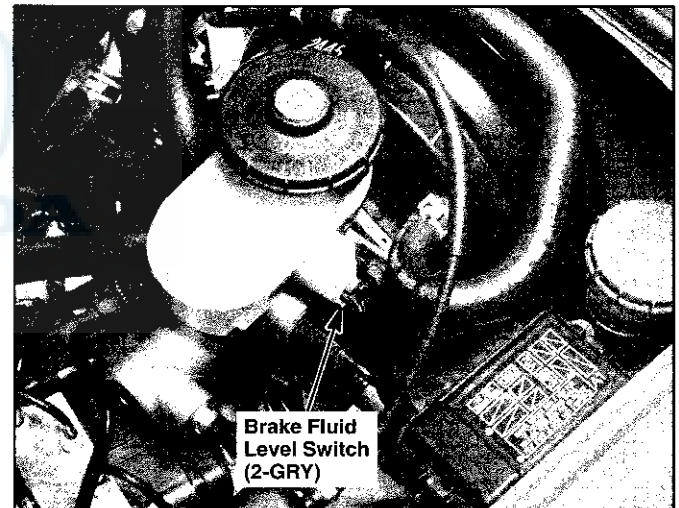

3. Left Side of Engine Compartment

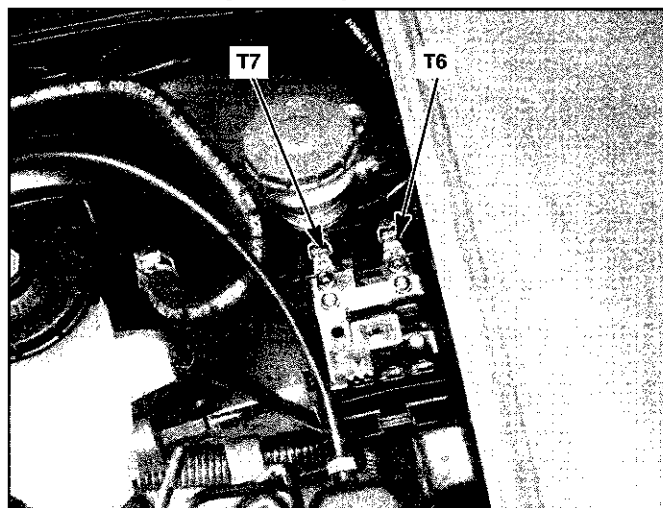

6. Left Side of Engine Compartment

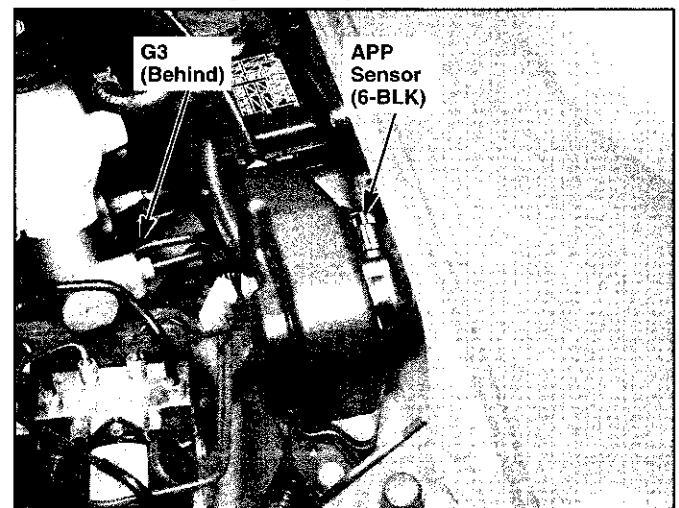



7. Left Side of Engine Compartment

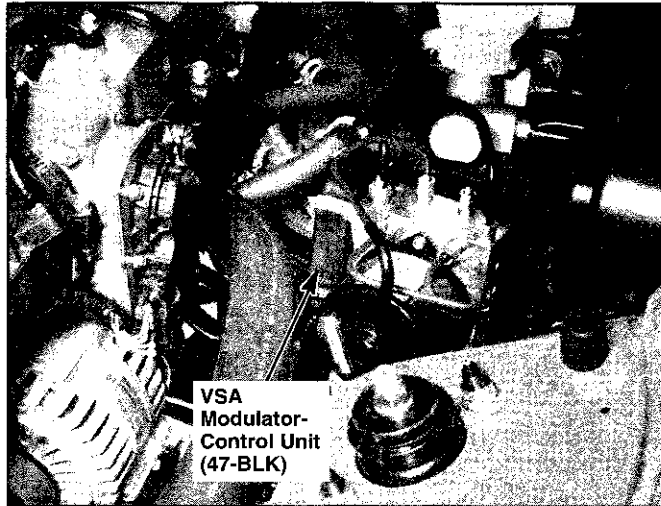

10. Left Side of Engine Compartment

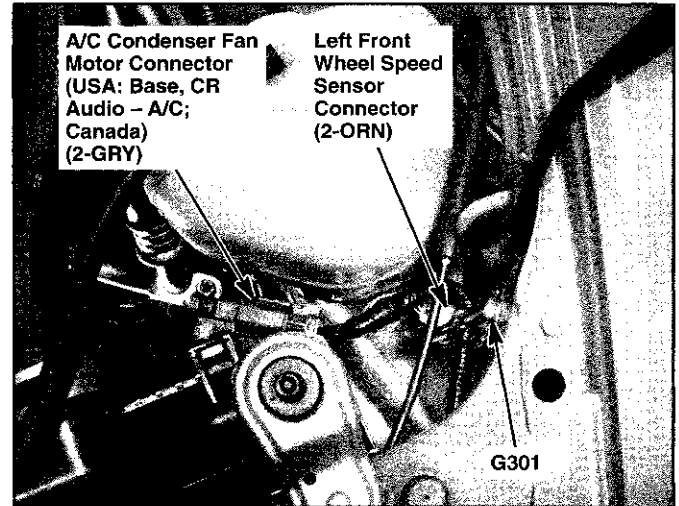

8. Left Side of Engine Compartment

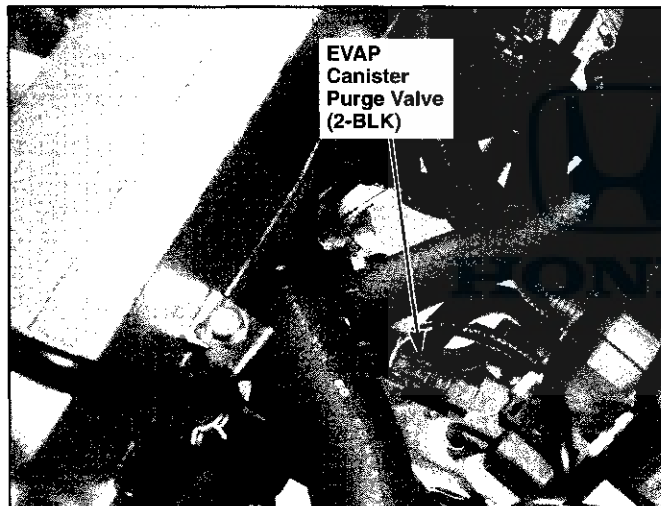

11. Left Side of Engine Compartment

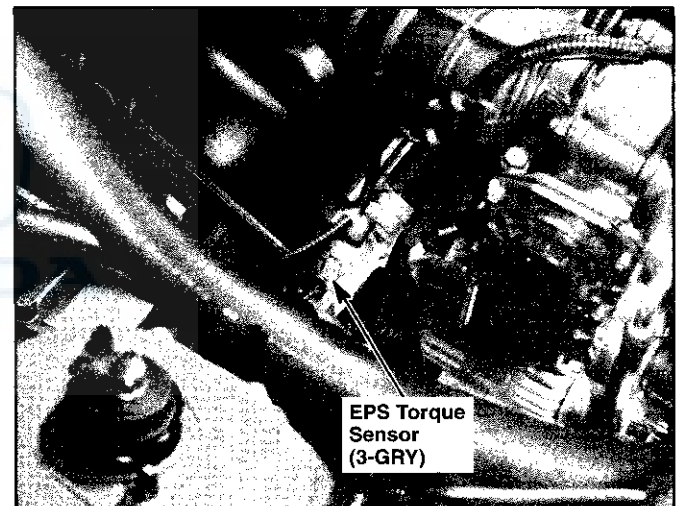

9. Below Cowl Cover

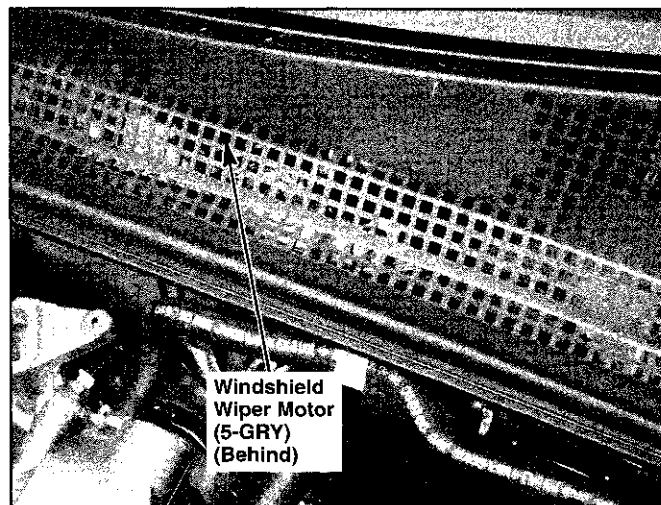

12. Left Side of Engine Compartment

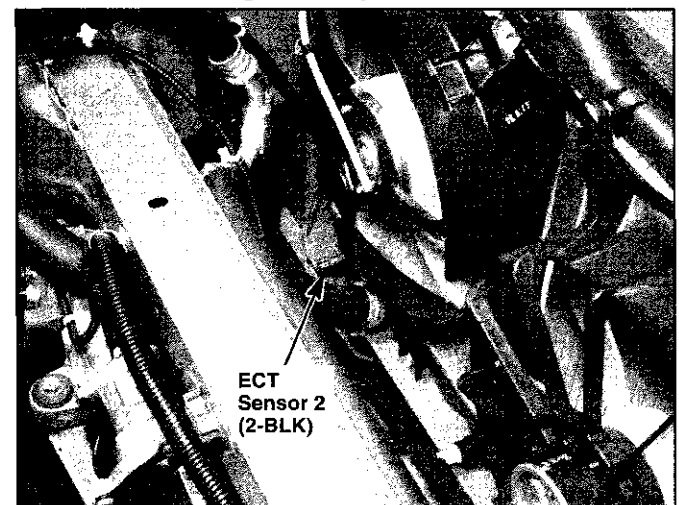



# Component Location

13. Left Side of Engine Compartment (Right Similar)

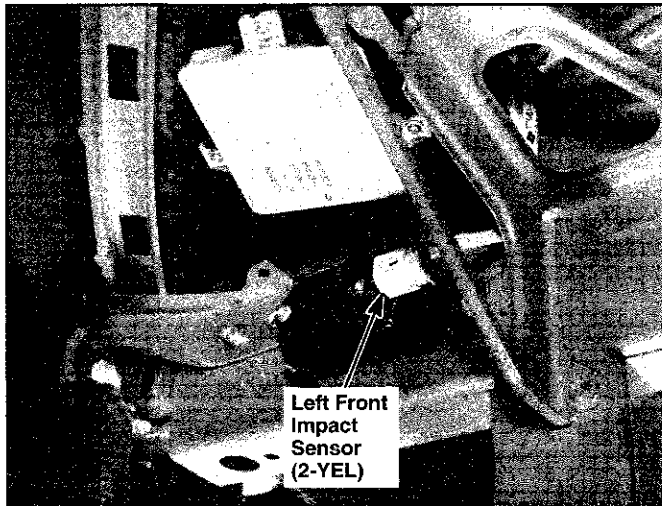

16. Behind Left Fender (Right Similar)

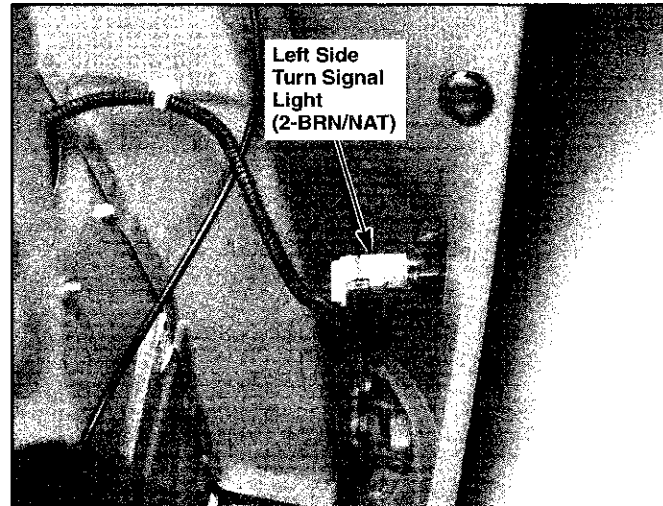

14. Behind Left Headlight (Right Similar)

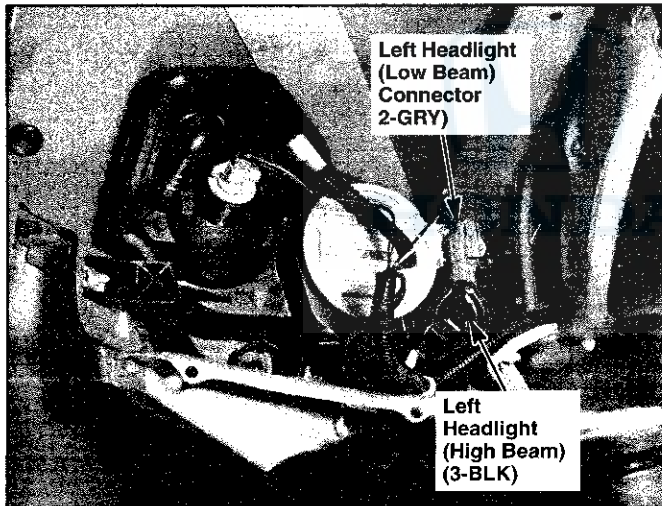

17. Right Side of Engine Compartment

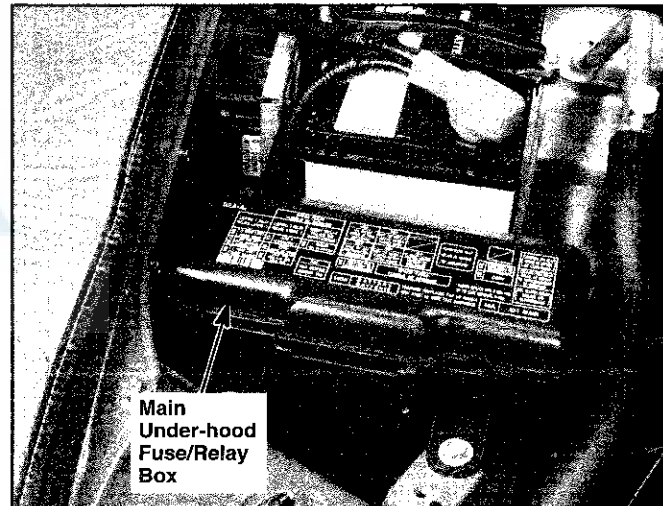

15. Behind Left Headlight (Right Similar)

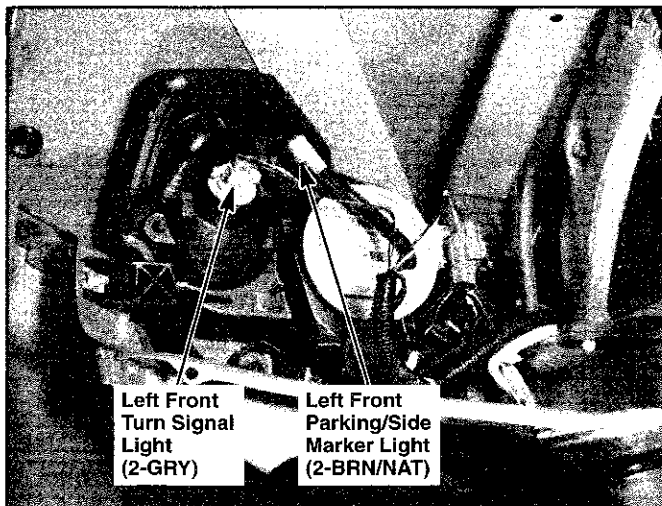

18. Right Side of Engine Compartment

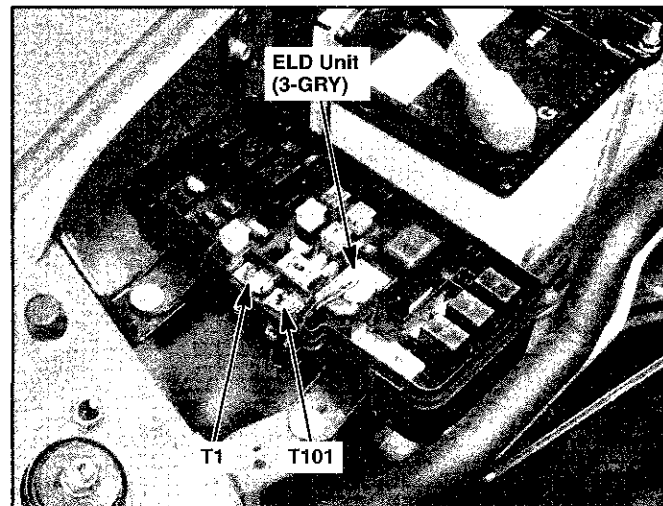



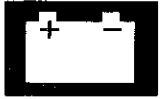

19. Right Side of Engine Compartment

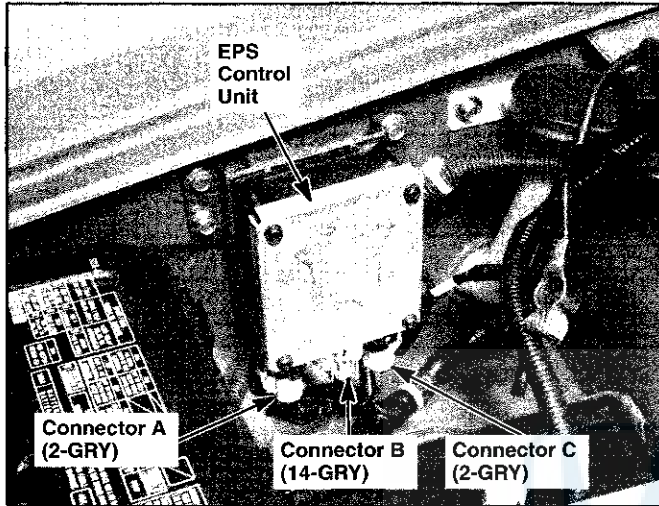

22. Right Side of Engine Compartment

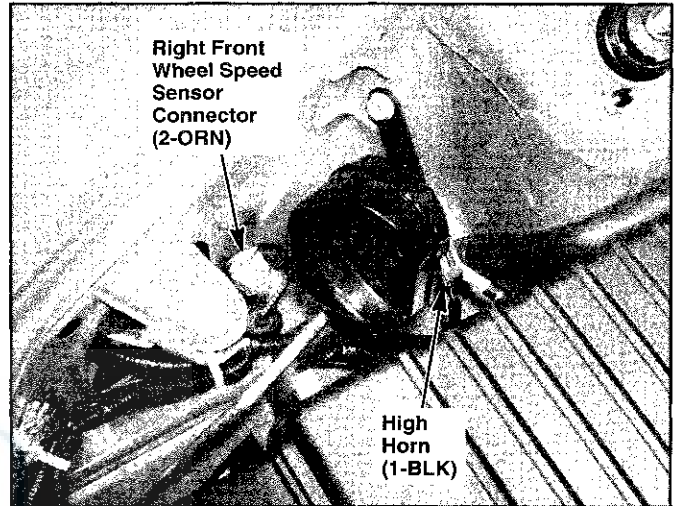

20. Right Side of Engine Compartment

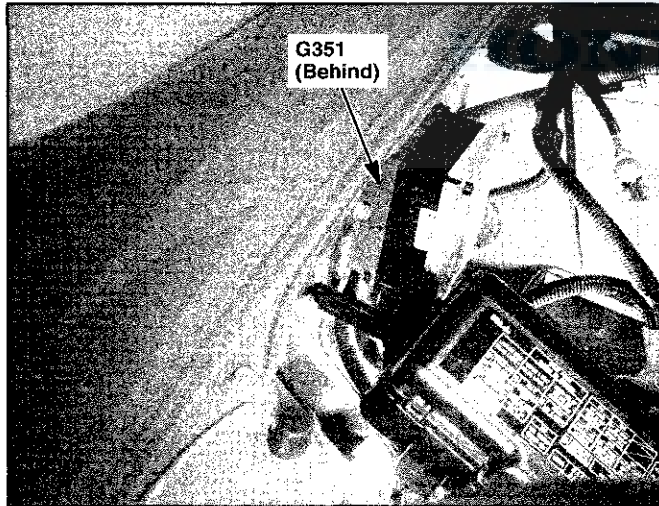

23. Right Side of Engine Compartment

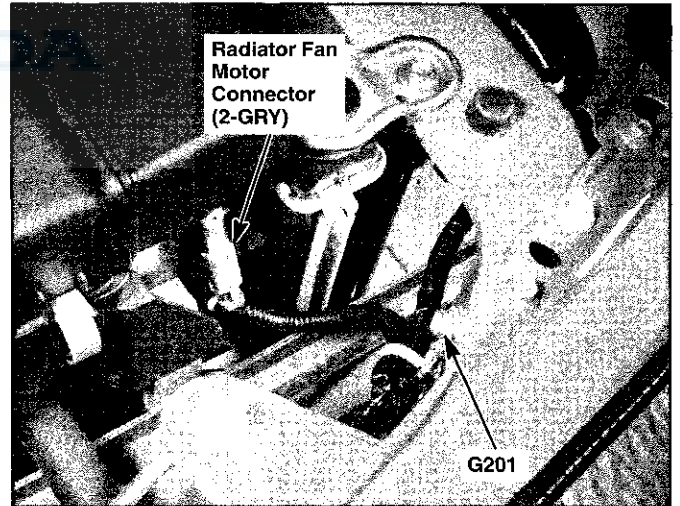

21. Right Side of Engine Compartment

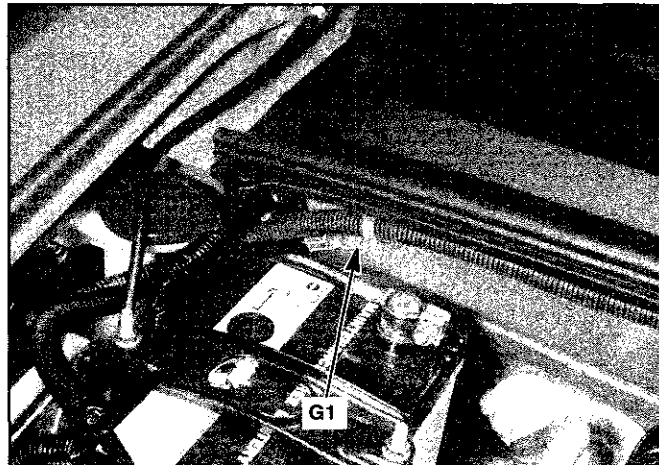

24. Behind Right Front Wheel Well

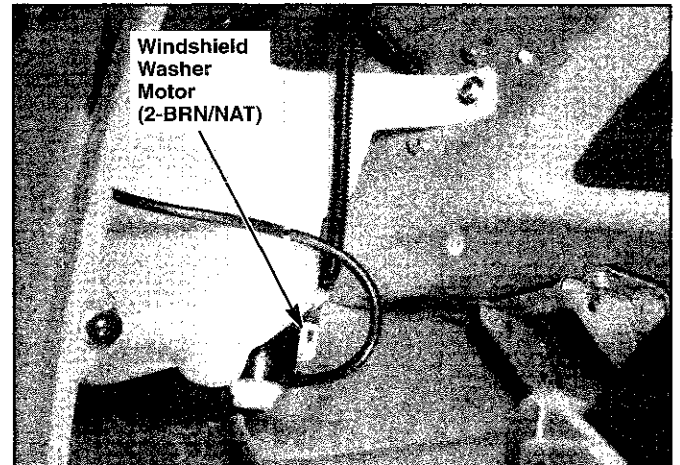



# Component Location

25. Behind Center of Front Bumper

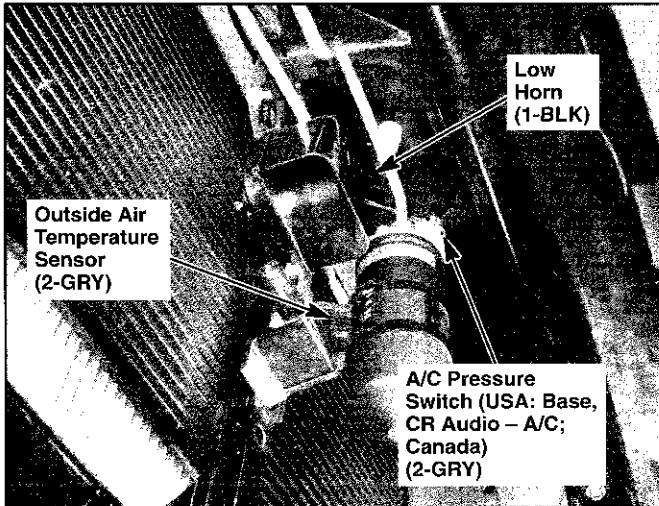

28. Left Side of Engine

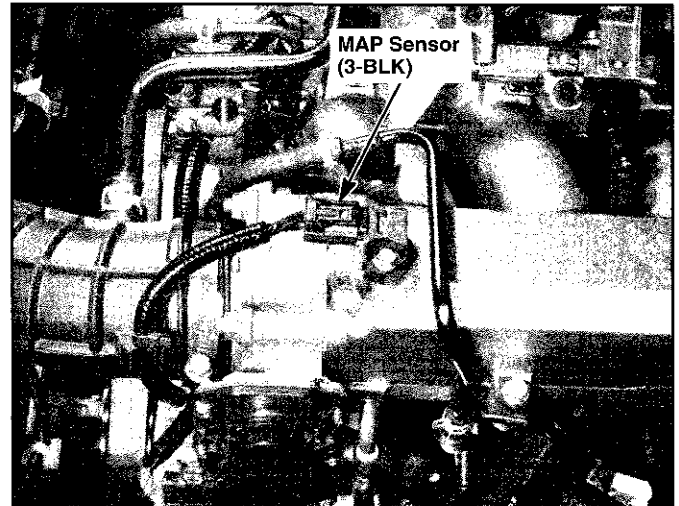

26. Engine Compartment (Below Front Beam)

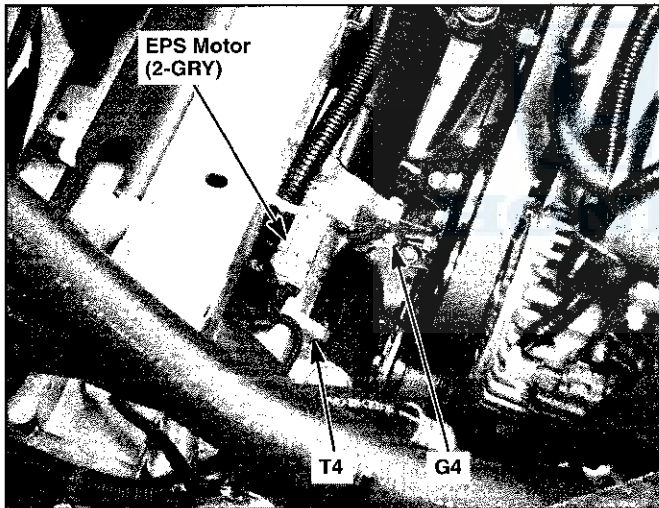

29. Left Side of Engine (USA: Base, CR Audio - A/C; Canada)

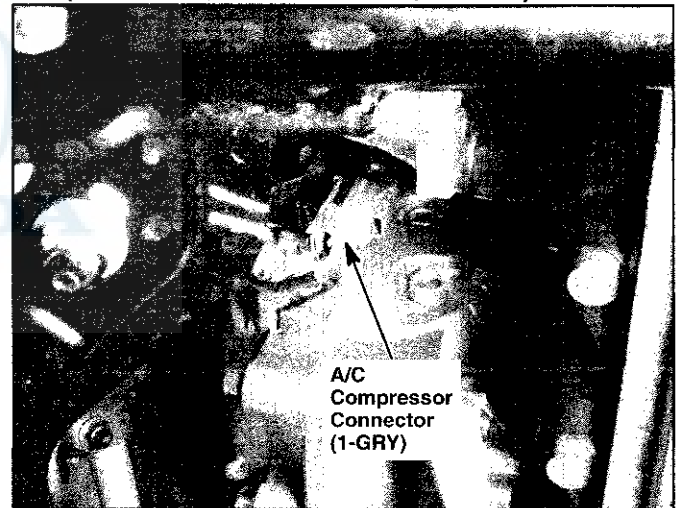

27. Left Side of Engine

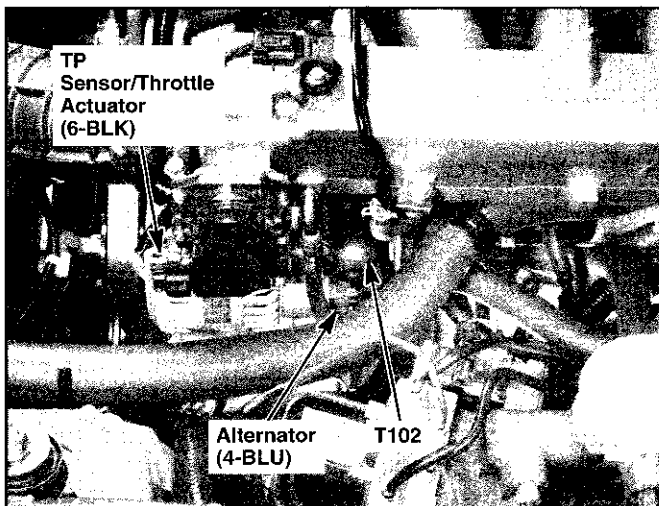

30. Left Side of Engine

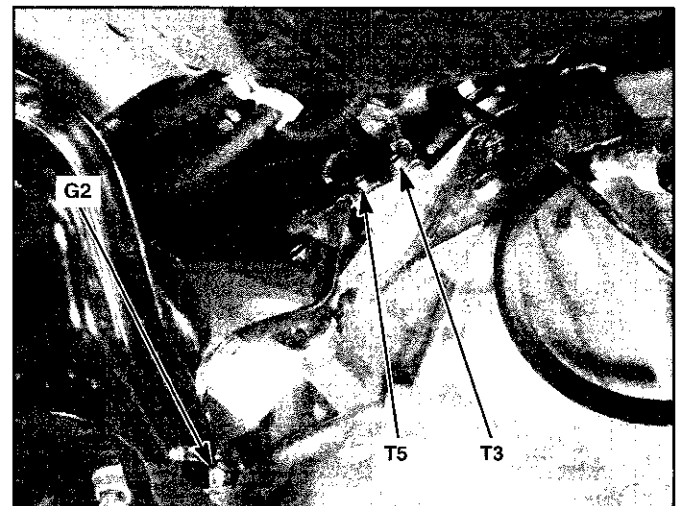





31. Left Side of Engine

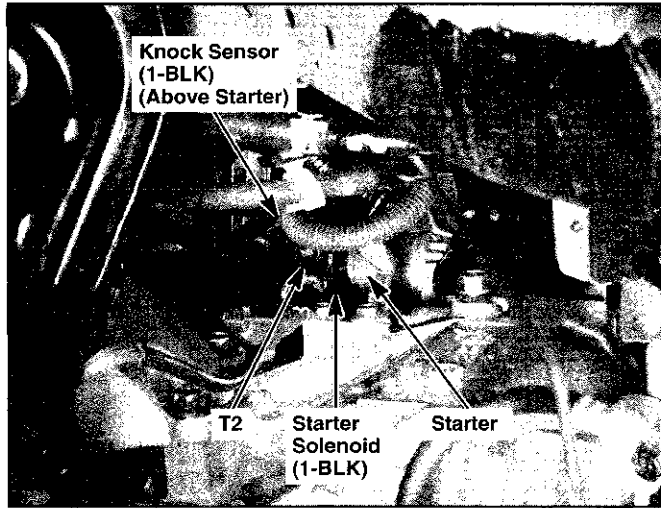

34. Middle of Engine

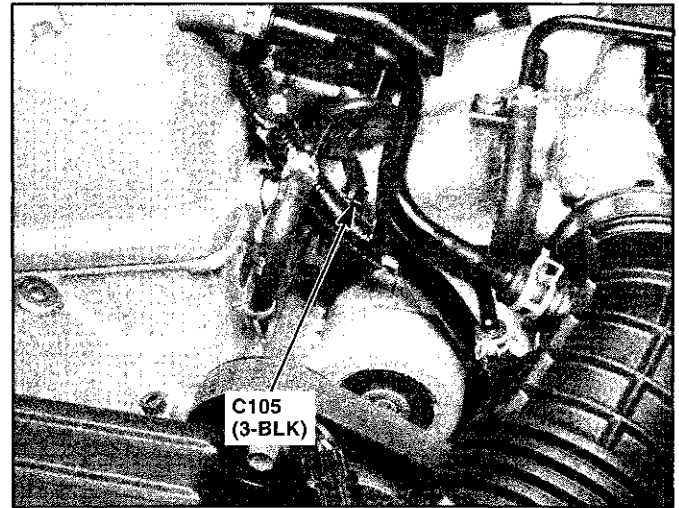

32. Middle of Engine (Cover Removed)

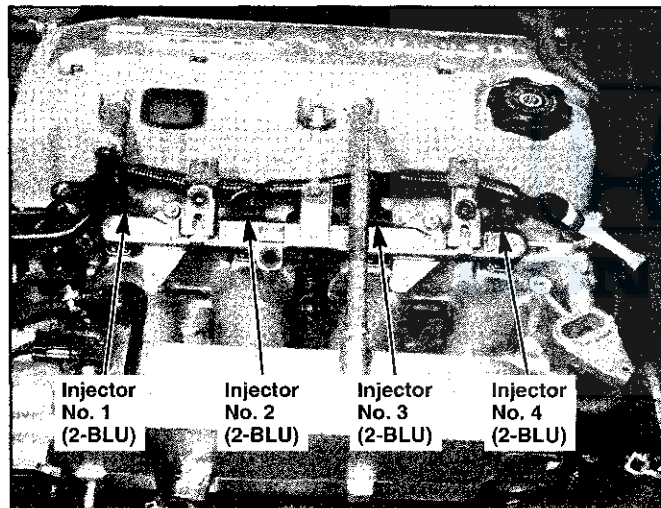

35. Rear of Engine

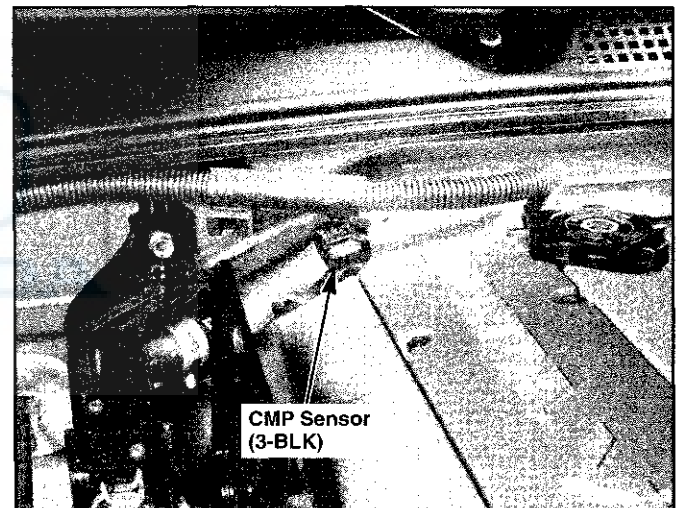

33. Middle of Engine

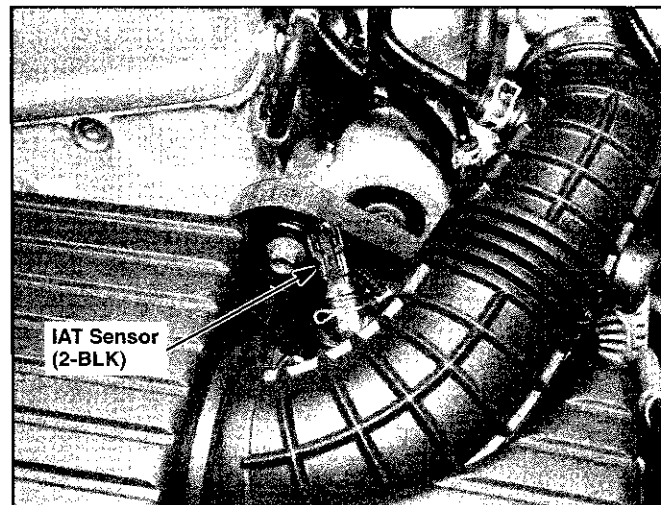

36. Middle of Engine

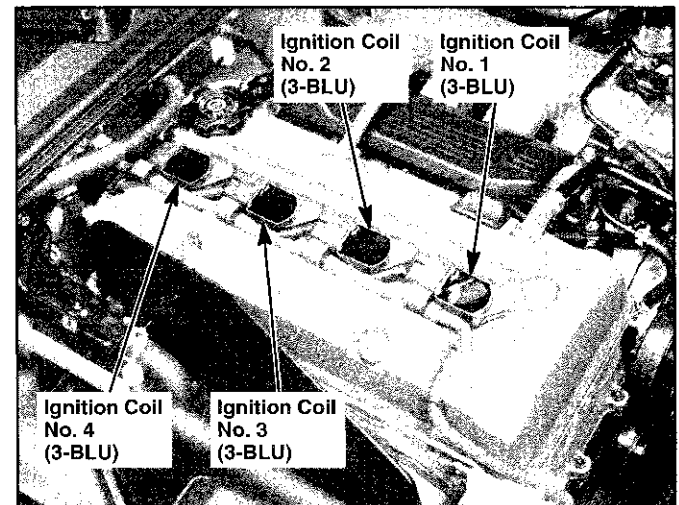

# Component Location

37. Rear of Engine

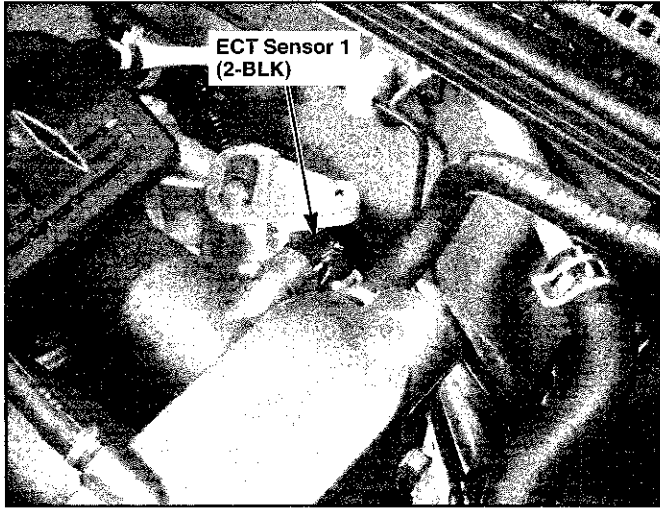

40. Front of Engine

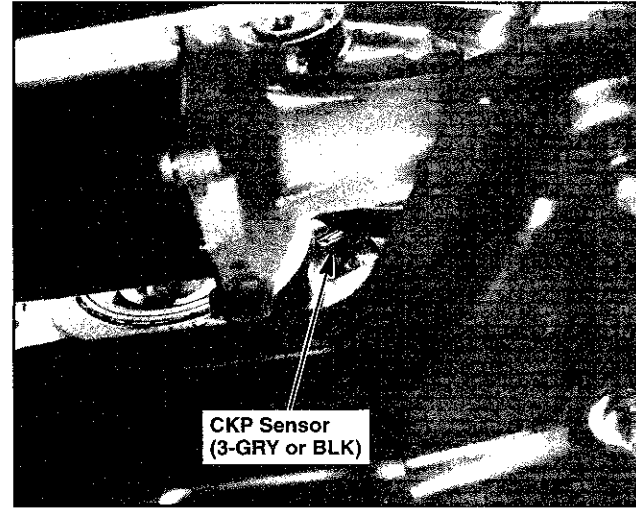

38. Rear of Engine

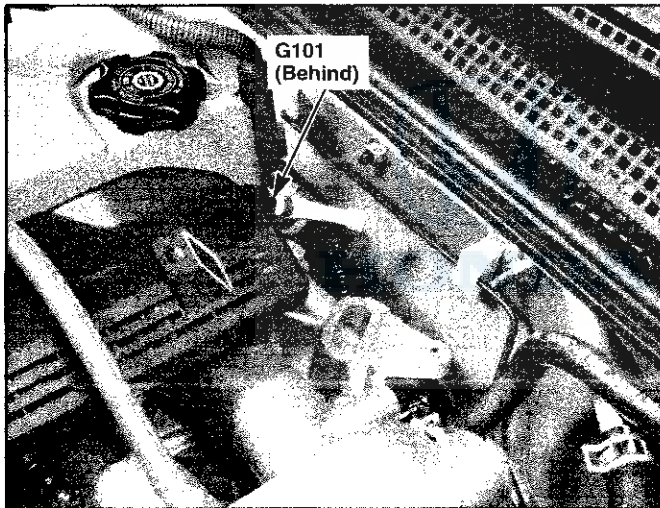

41. Left Side of Transmission

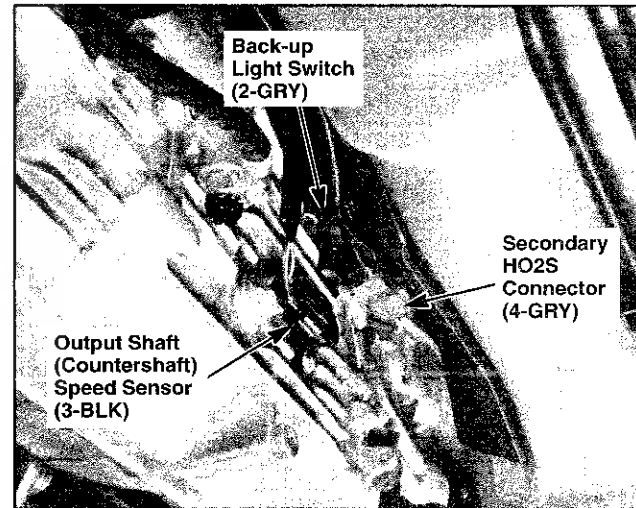

39. Right Side of Engine

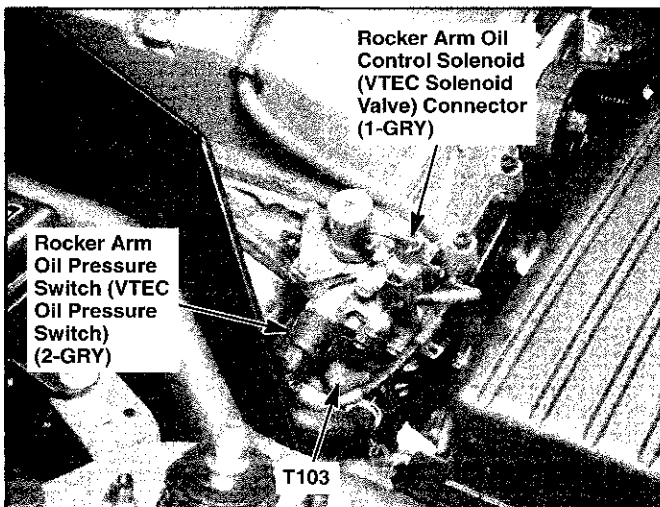

42. Transmission Housing

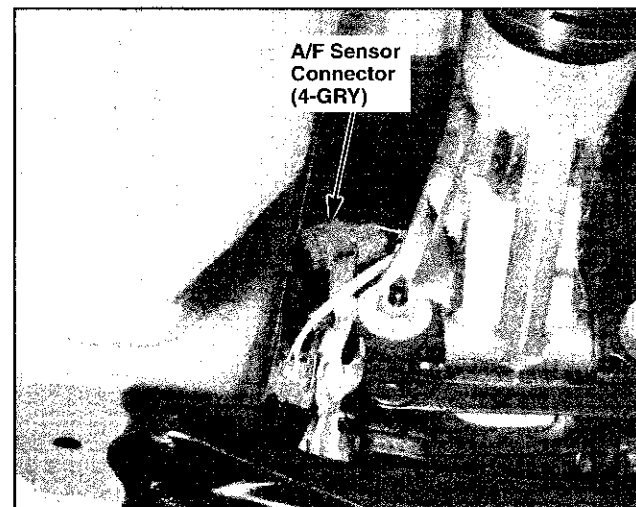





43. Under Left Side of Dash

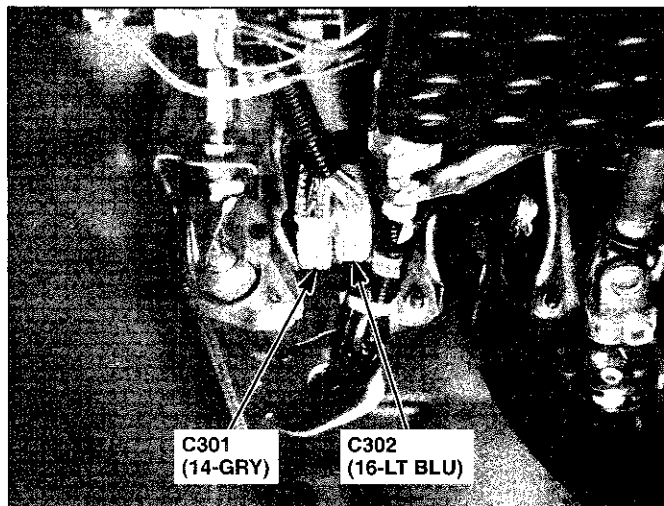

46. Under Left Side of Dash

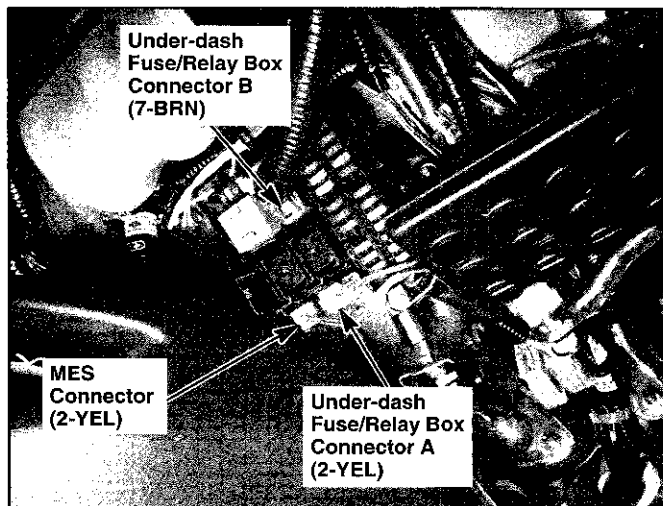

44. Under Left Side of Dash

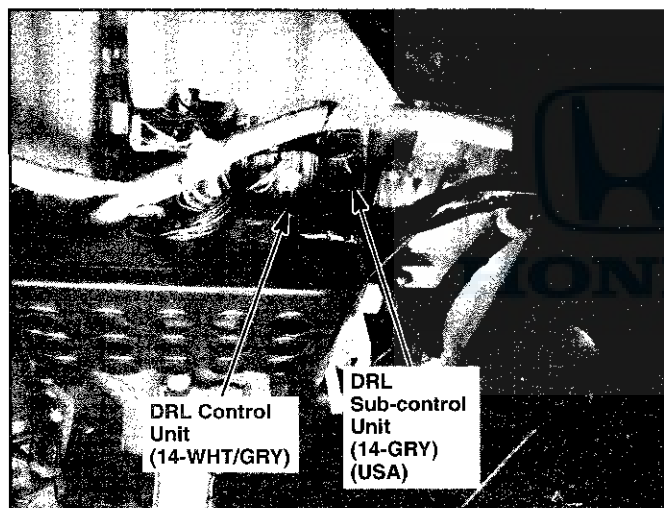

47. Under Left Side of Dash

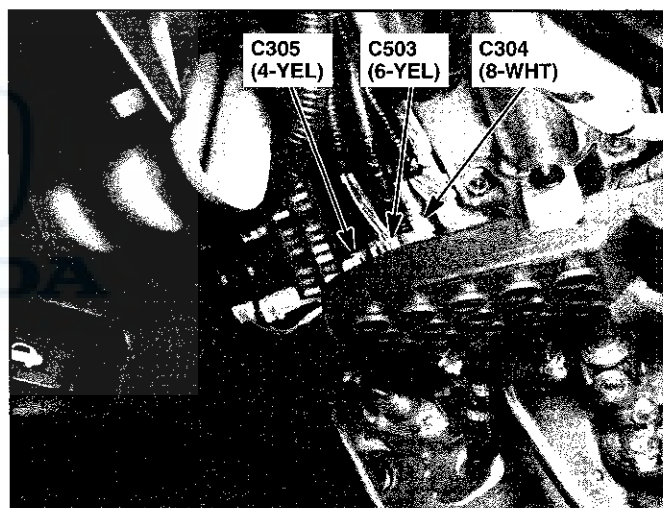

45. Under Left Side of Dash

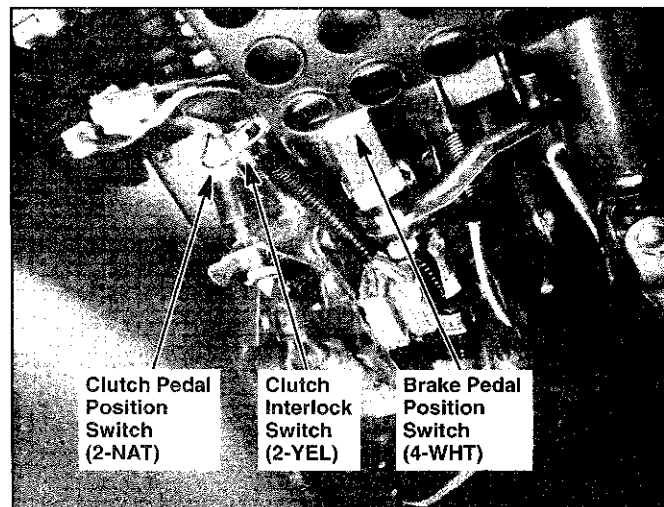

48. Under Left Side of Dash

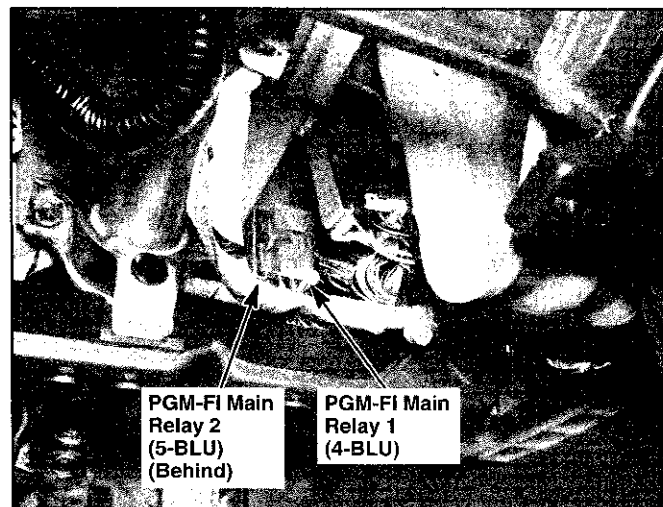

# Component Location

49. Under Left Side of Dash

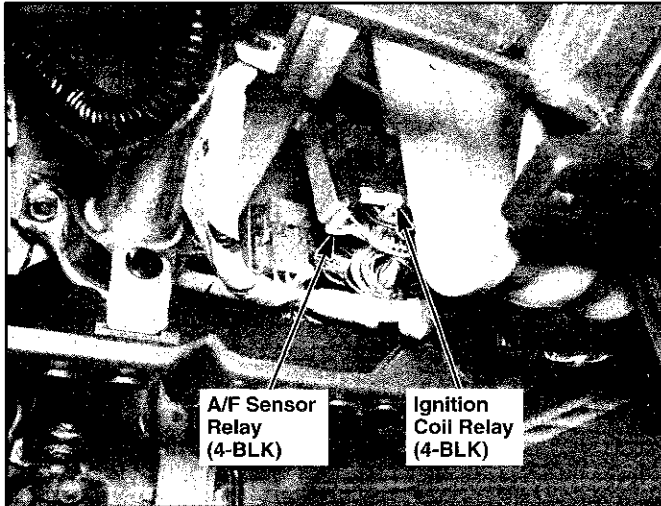

52. Under Left Side of Dash

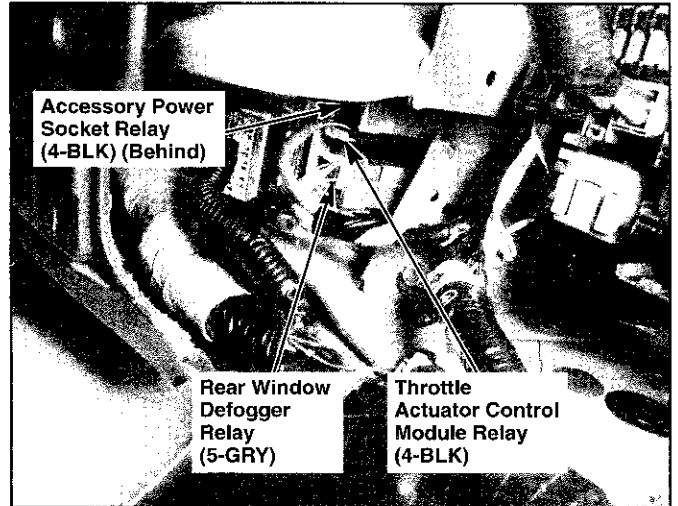

50. Under Left Side of Dash

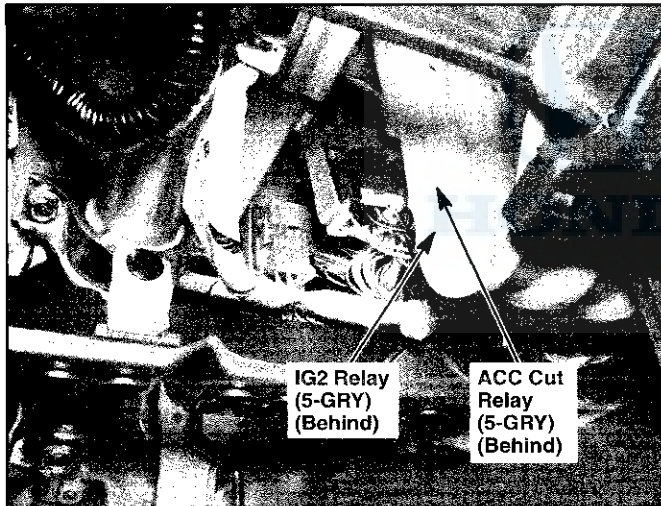

53. Under Left Side of Dash

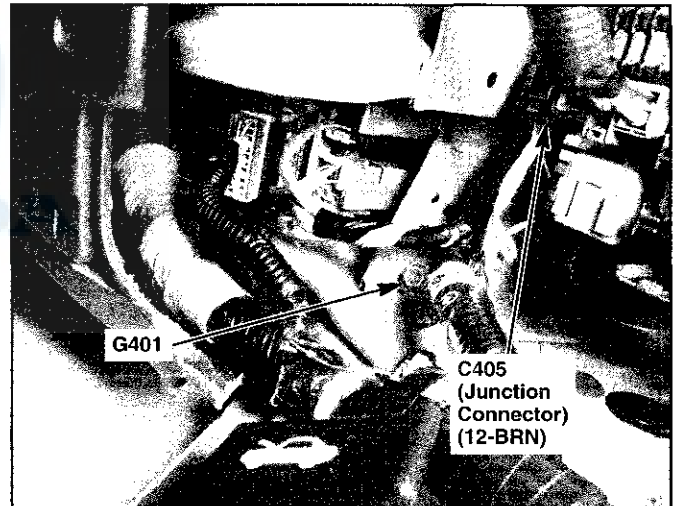

51. Under Left Side of Dash

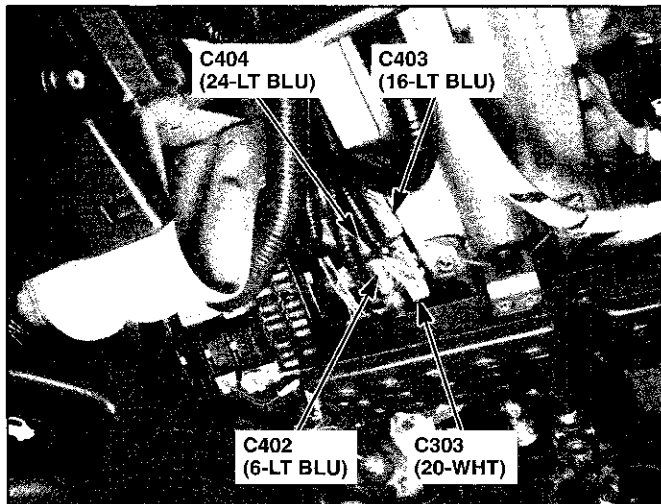

54. Under Left Side of Dash

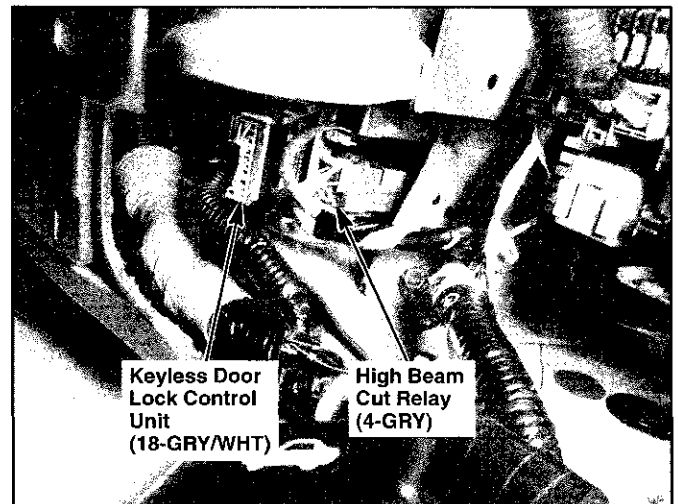



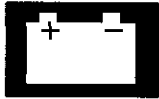

55. Behind Left Kick Panel

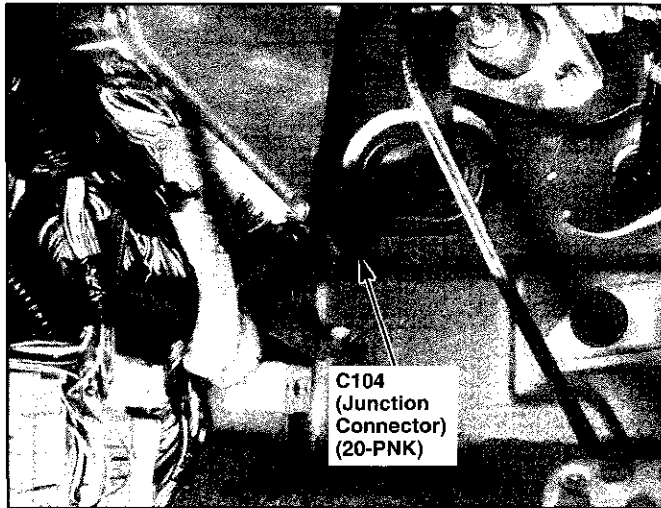

58. Behind Left Kick Panel

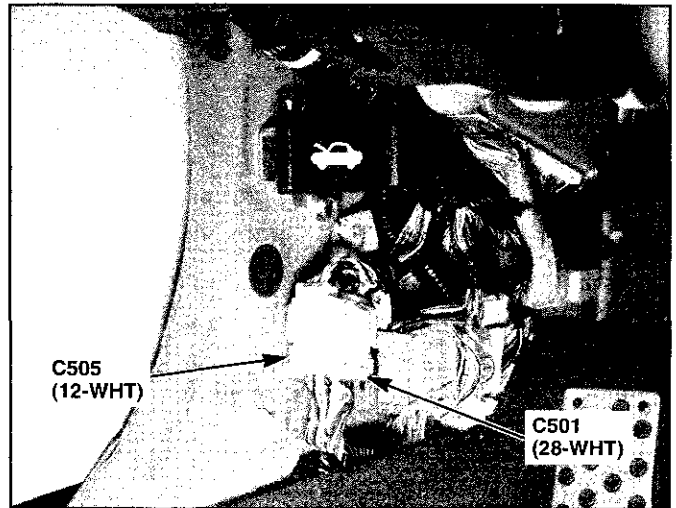

56. Behind Left Kick Panel

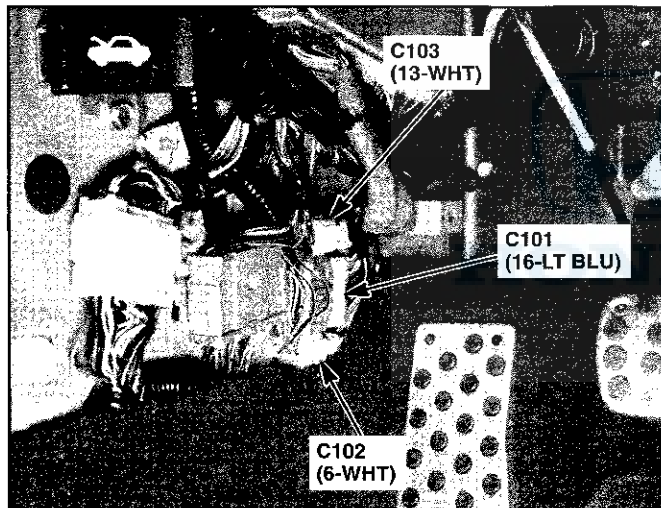

59. Behind Left Kick Panel

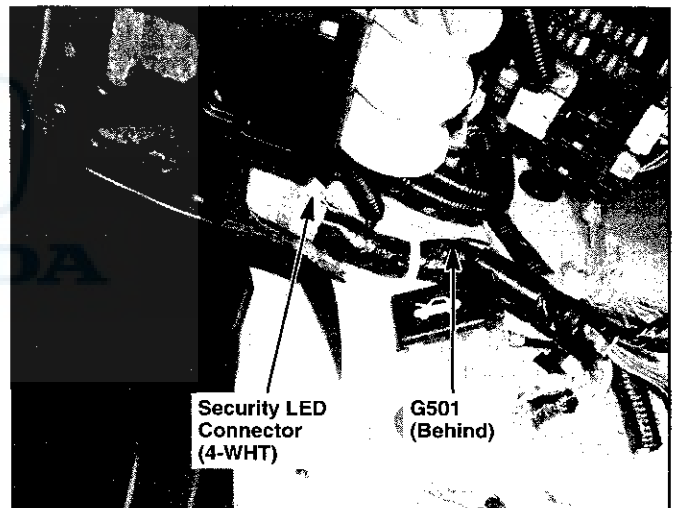

57. Behind Left Kick Panel

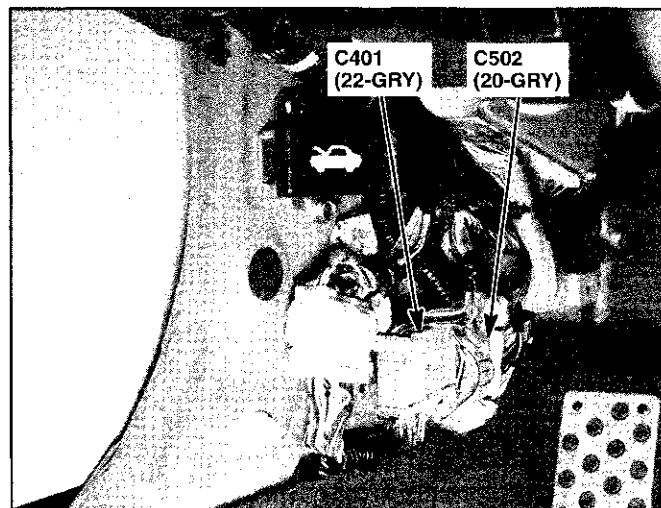

60. Behind Left Kick Panel

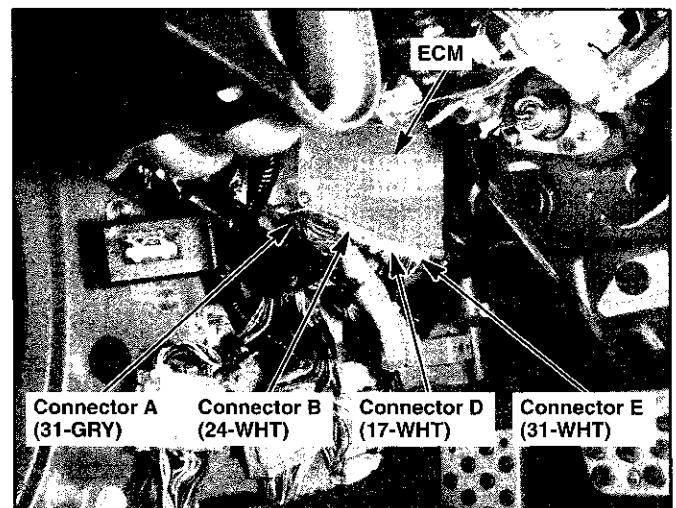

# Component Location

61. Under Left Middle of Dash

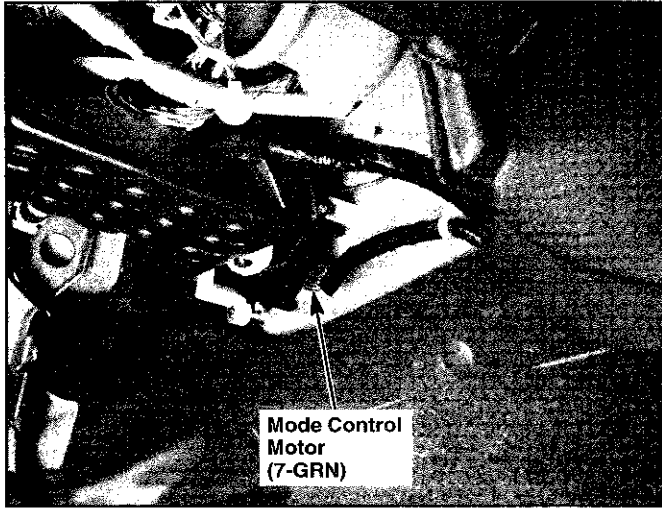

64. Right of Steering Wheel

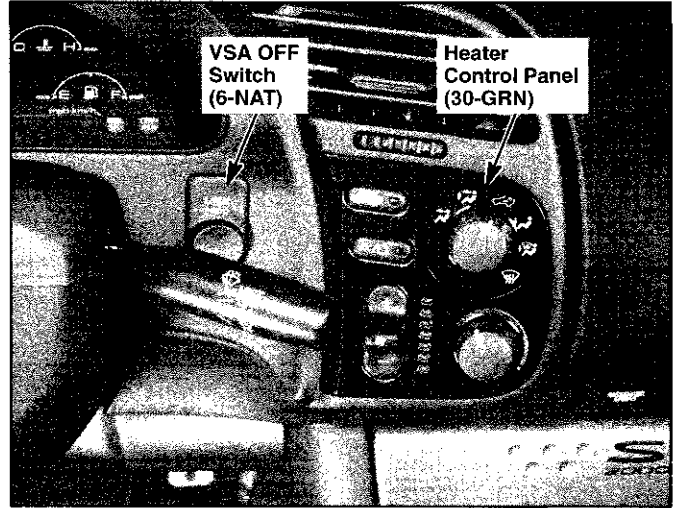

62. Under Left Middle of Dash



65. Behind Gauge Assembly

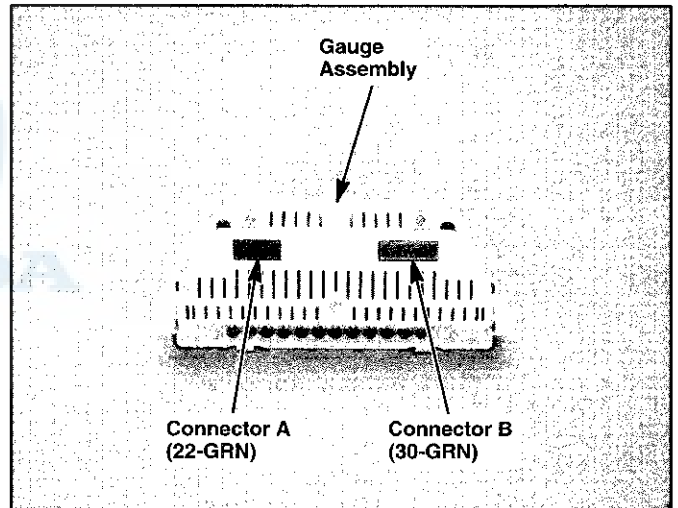

63. Left of Steering Wheel

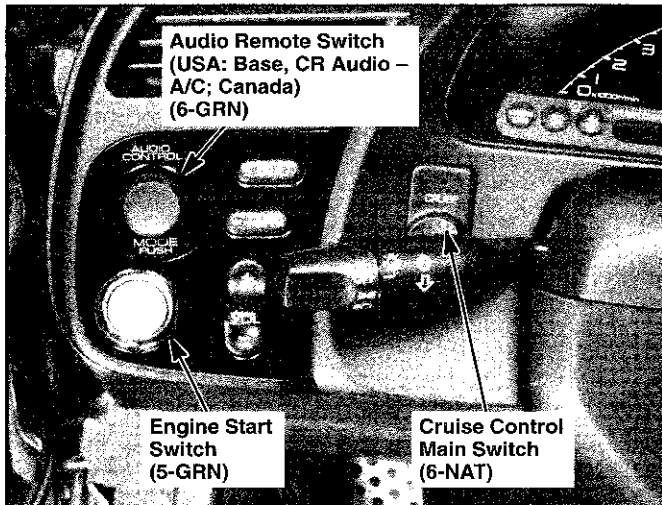

66. Steering Wheel (Airbag Inflator Removed)

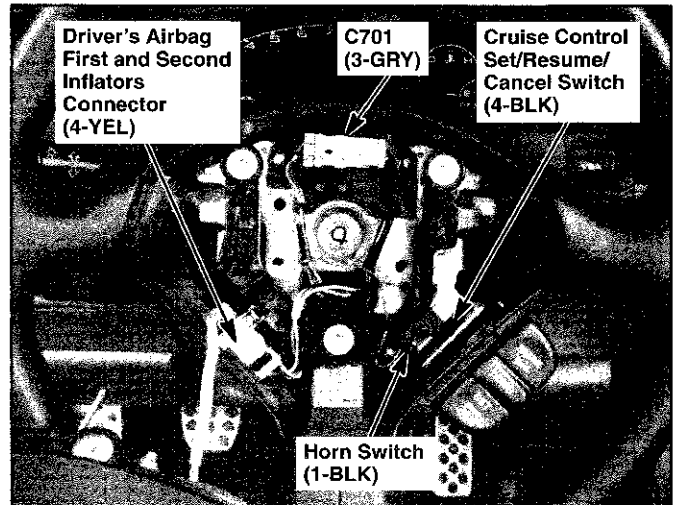



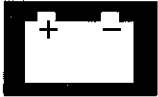

67. In Steering Column Cover

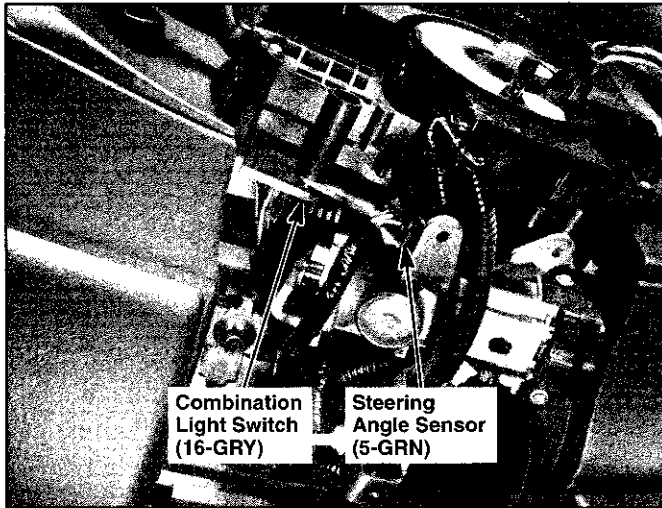

70. In Steering Column Cover

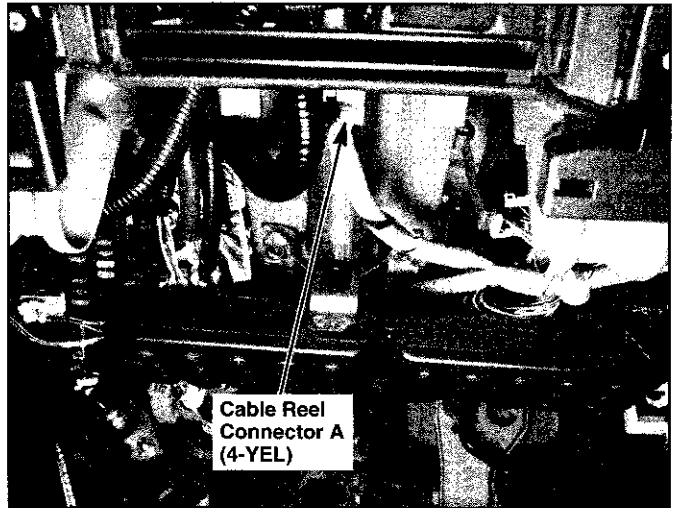

68. In Steering Column Cover

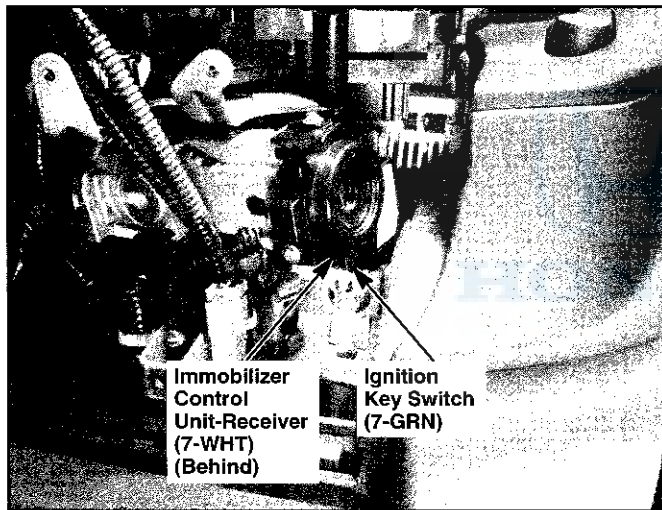

71. Center of Dash

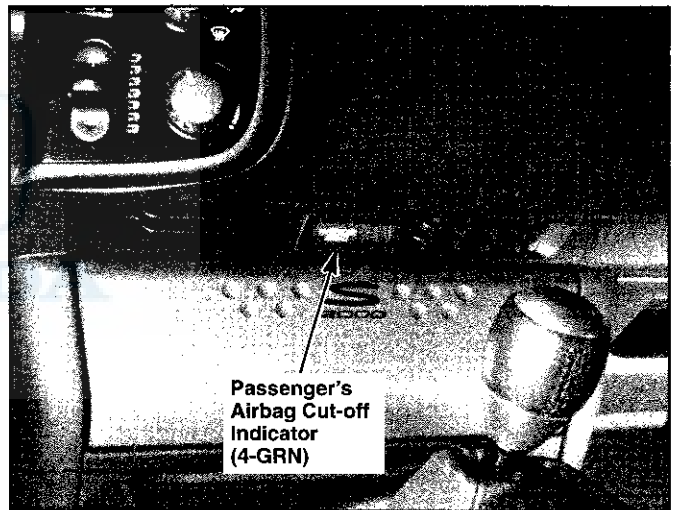

69. In Steering Column Cover

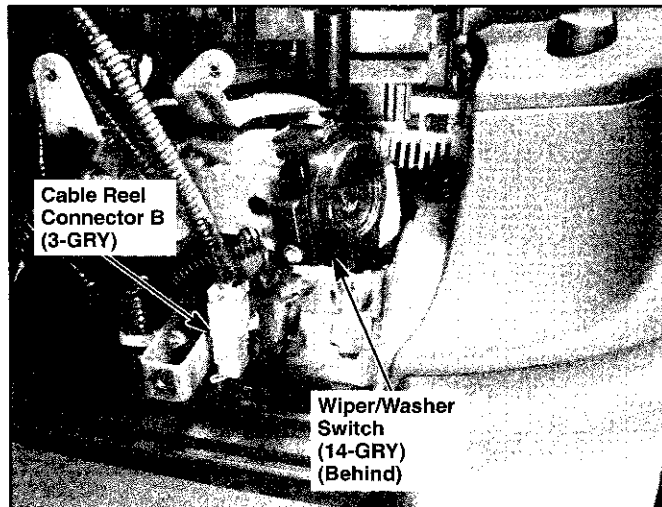

72. Behind Audio Unit (USA: Base, CR Audio - A/C; Canada)

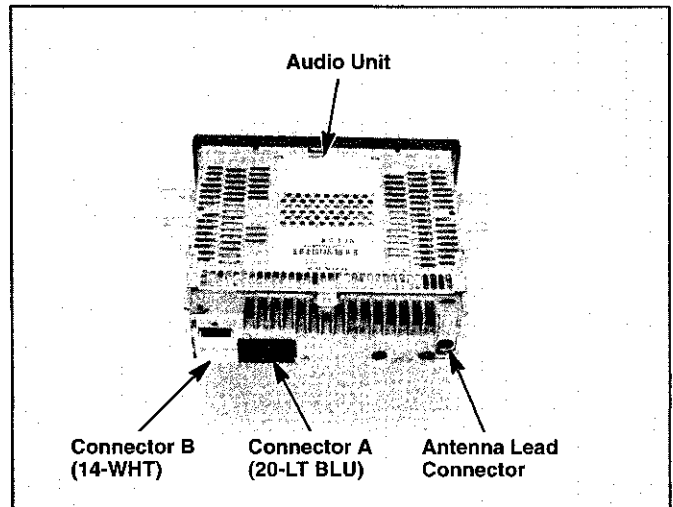

# Component Location

73. Behind Lower Center of Dash

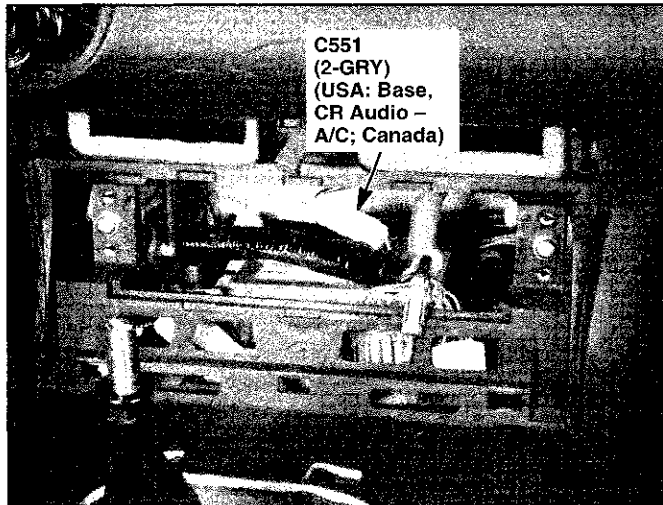

76. Below Center of Console

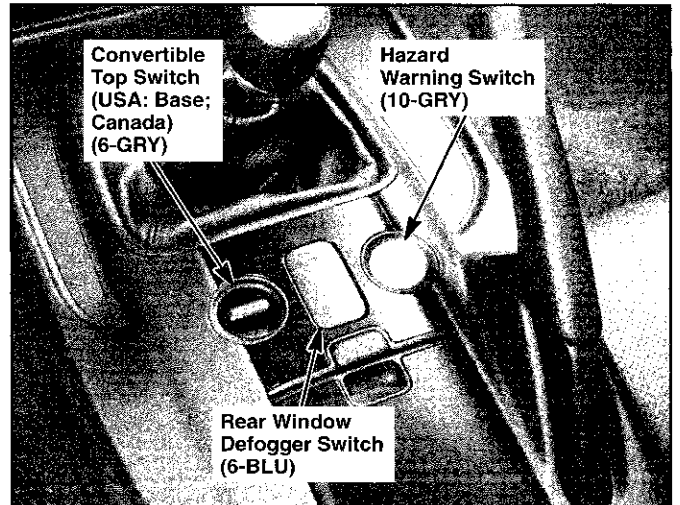

74. Behind Lower Center of Dash

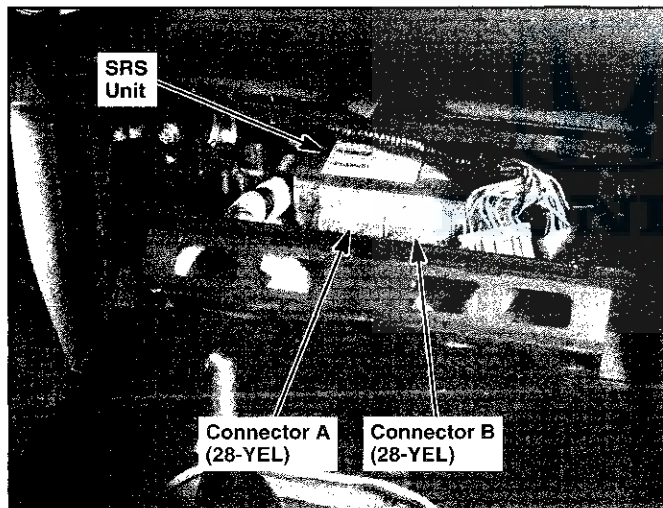

77. Behind Rear of Console (Opened)

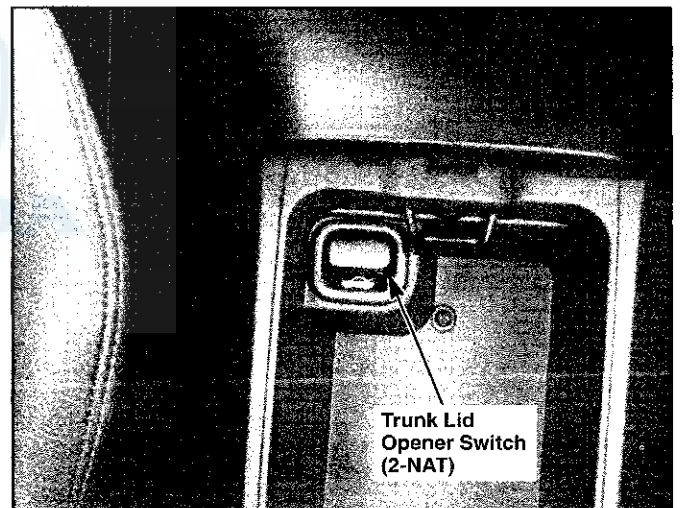

75. Behind Lower Center of Dash



78. Behind Rear of Console

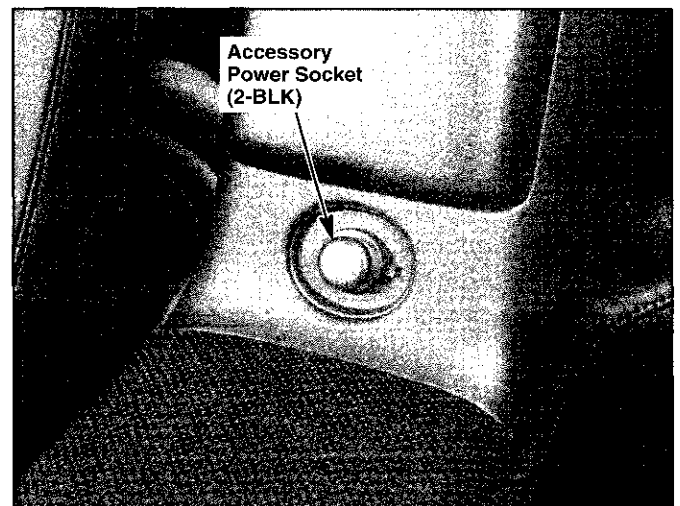





79. Below Center of Console



82. Under Right Side of Dash

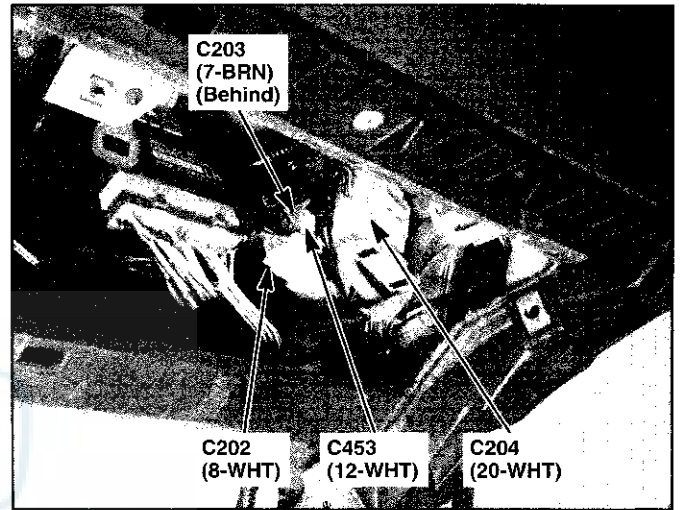

80. Under Middle of Dash

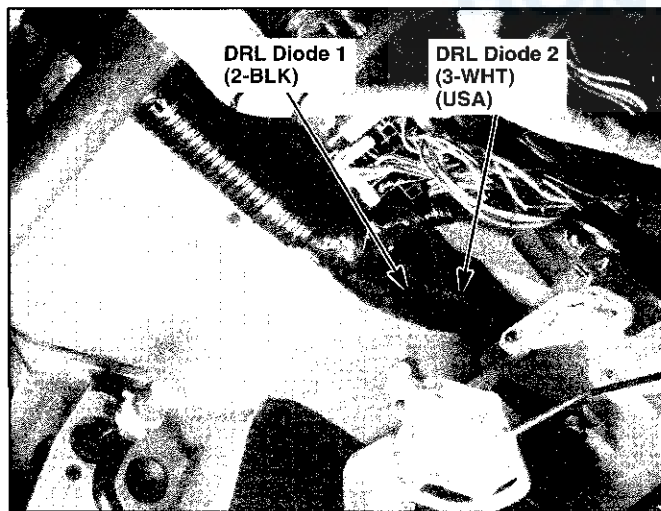

83. Under Right Side of Dash

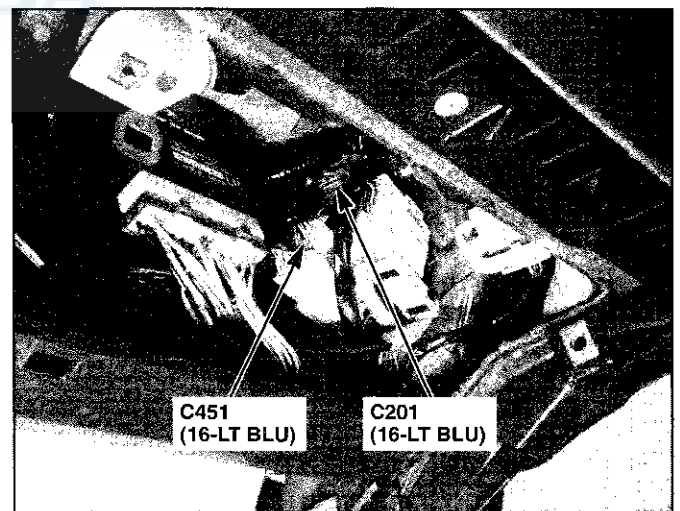

81. Under Right Side of Dash

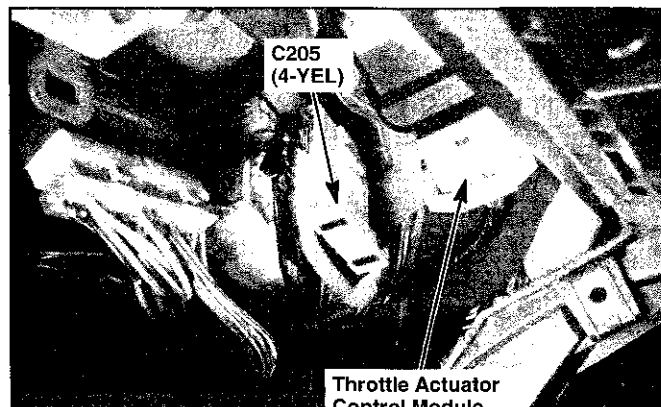

84. Under Right Side of Dash



# Component Location

85. Under Right Side of Dash (USA: Base; Canada)

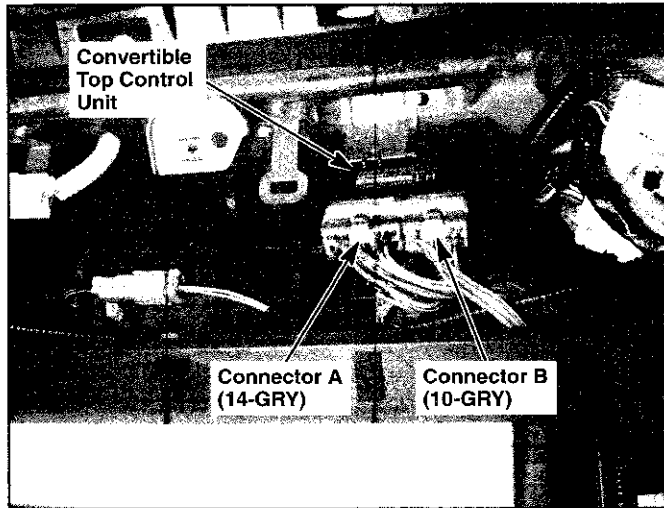

88. Under Right Side of Dash

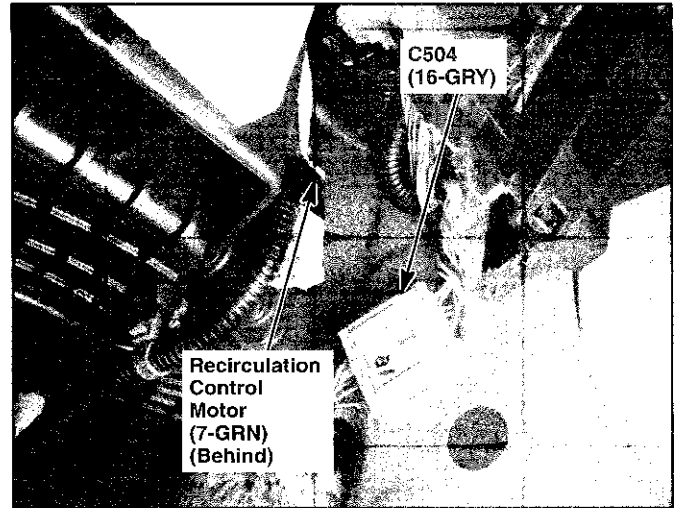

86. Under Right Side of Dash

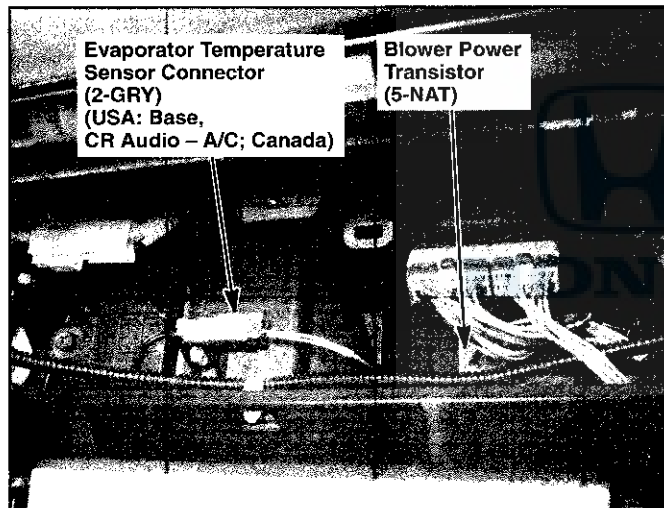

89. Under Right Side of Dash (USA: Base; Canada)

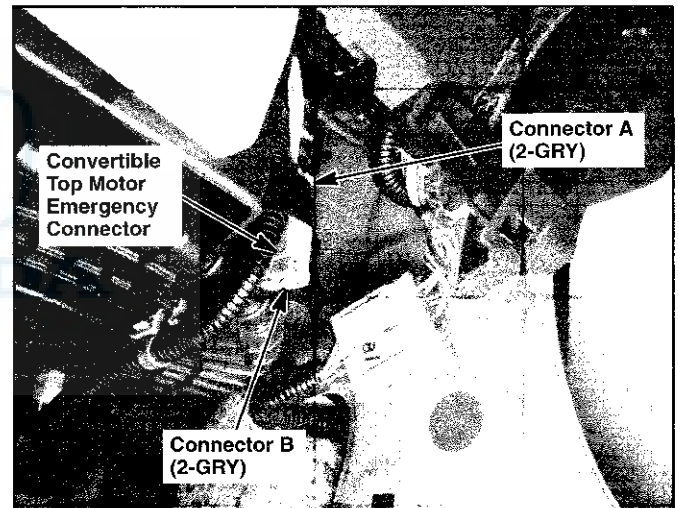

87. Under Right Side of Dash

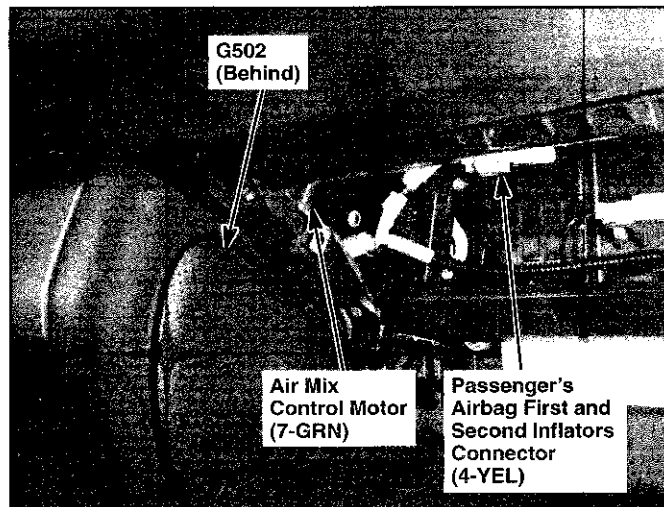

90. Under Right Side of Dash

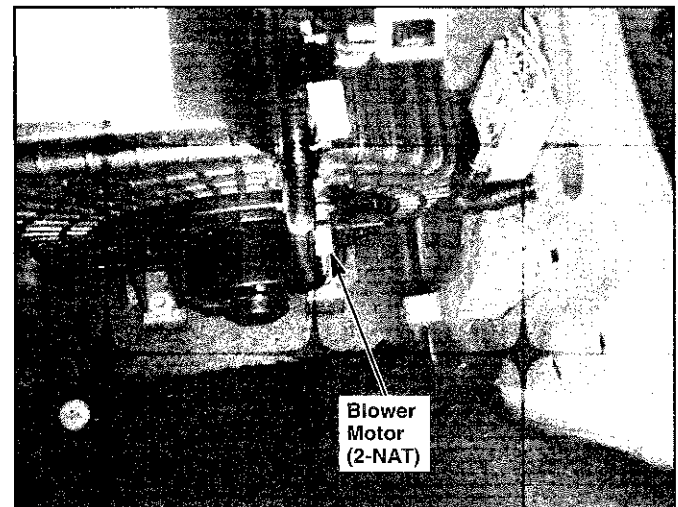





91. Under Left Side of Floor

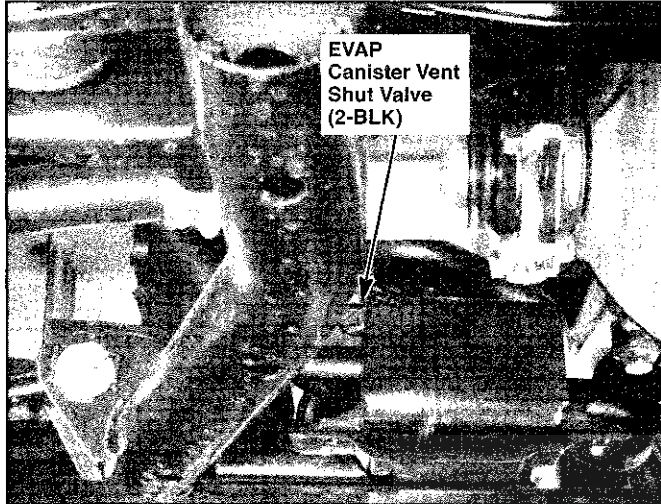

94. Behind Left Side Rear Trim (Removable Hardtop)

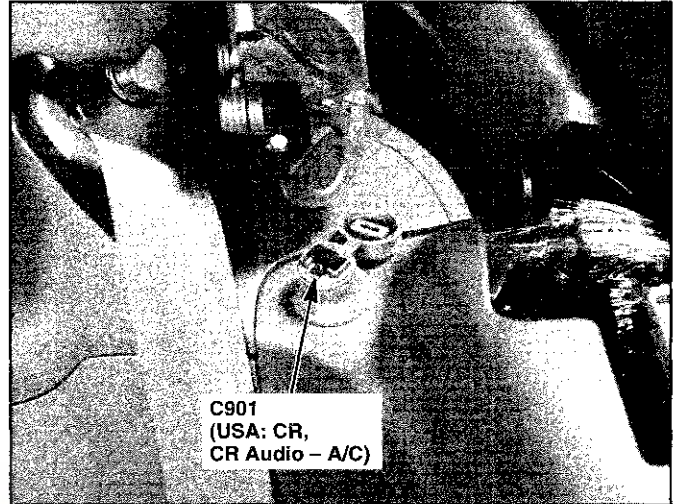

92. Under Left Side of Floor

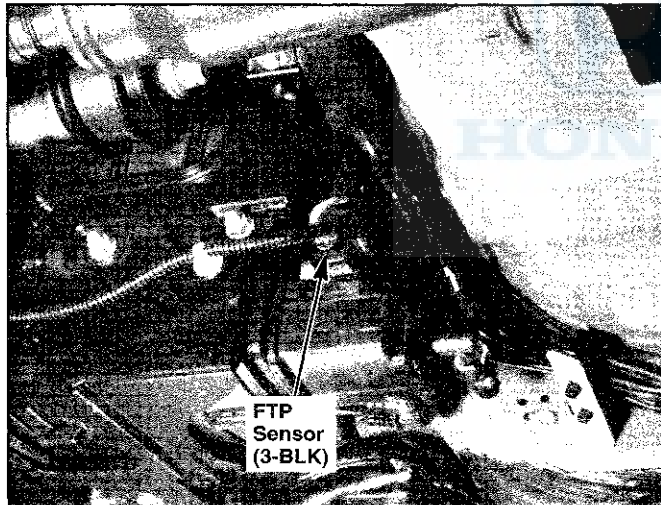

95. Behind Rear of Console

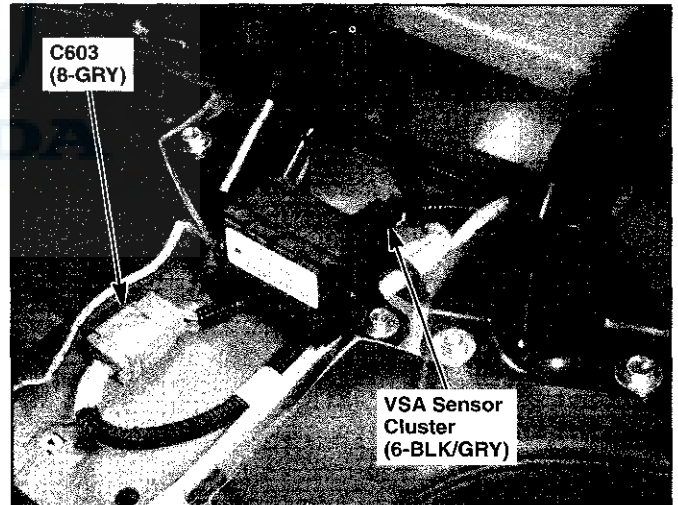

93. Behind Left Side Rear Trim

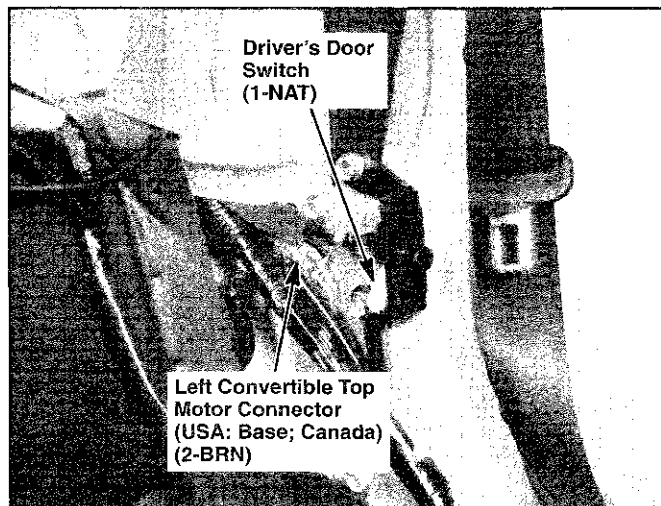

96. Behind Right Side Rear Trim

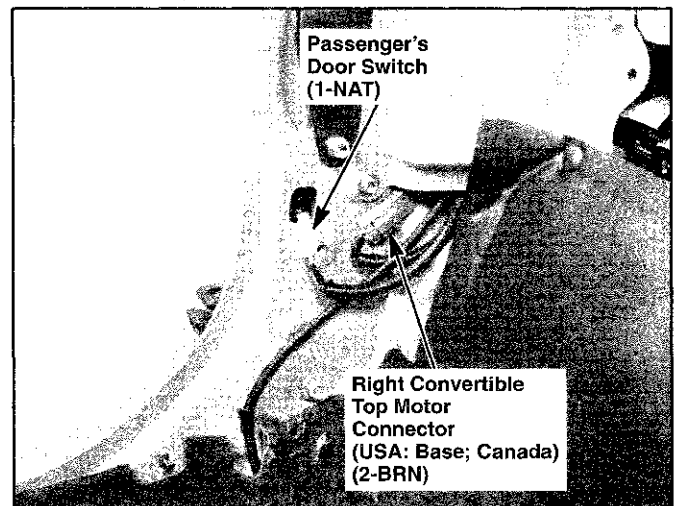



# Component Location

97. Driver's Door

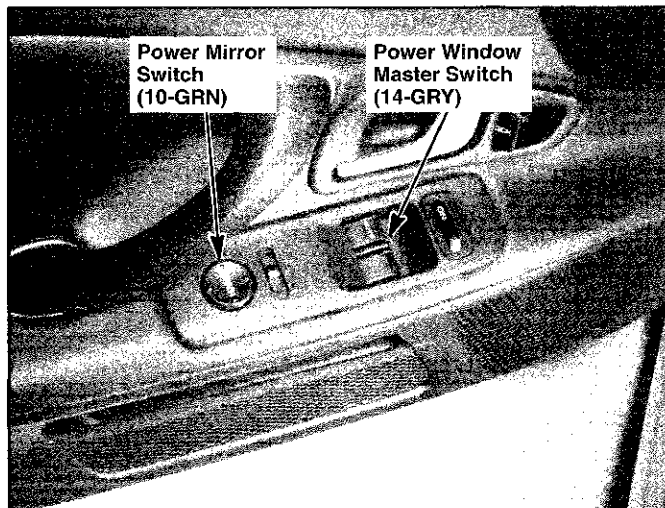

100. Driver's Door (Passenger's Similar)

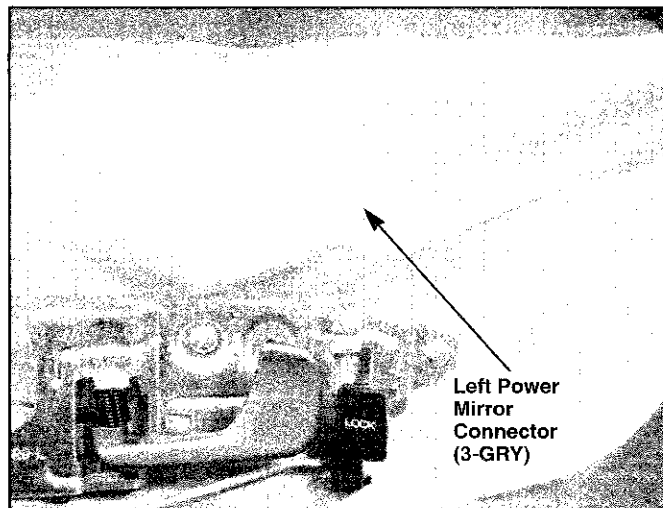

98. Driver's Door (Passenger's Similar)

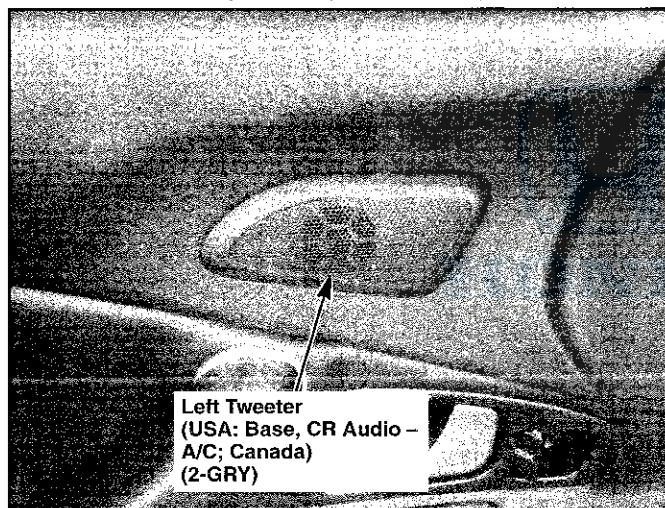

101. Driver's Door (Passenger's Similar)

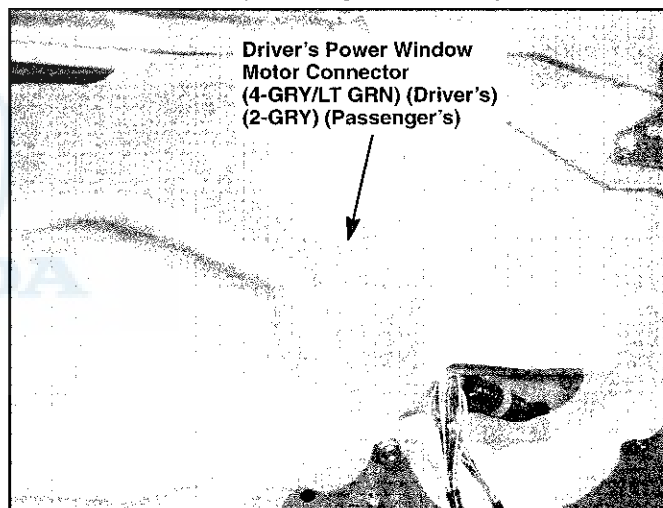

99. Driver's Door (Passenger's Similar)

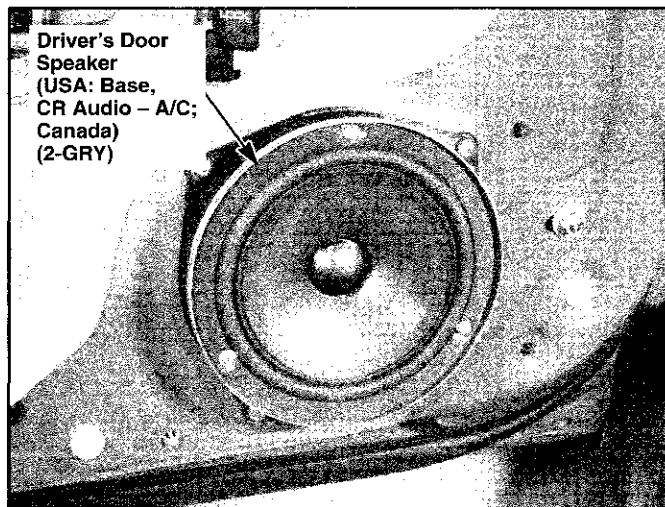

102. Driver's Door

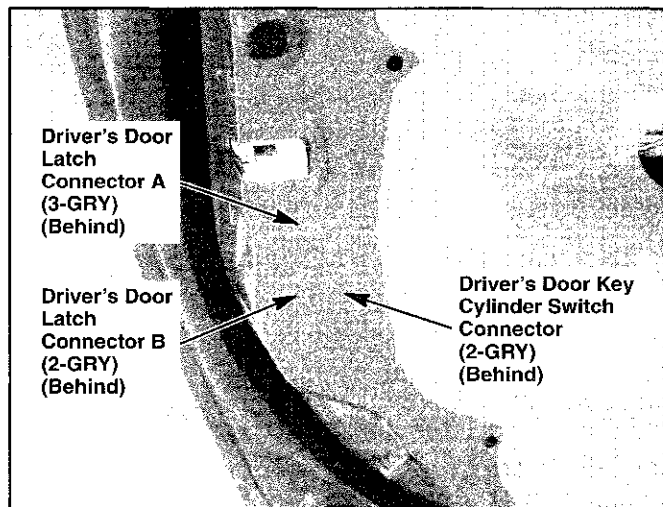



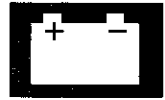

103. Under Driver's Roll Bar (USA: Base, CR Audio – A/C; Canada)

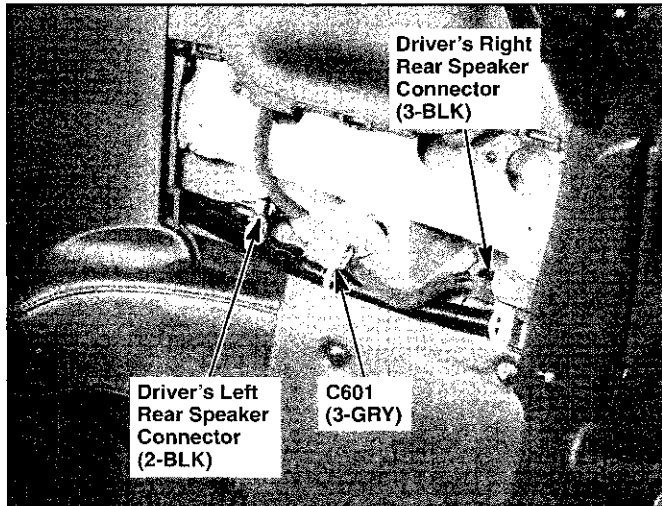

106. Passenger's Door

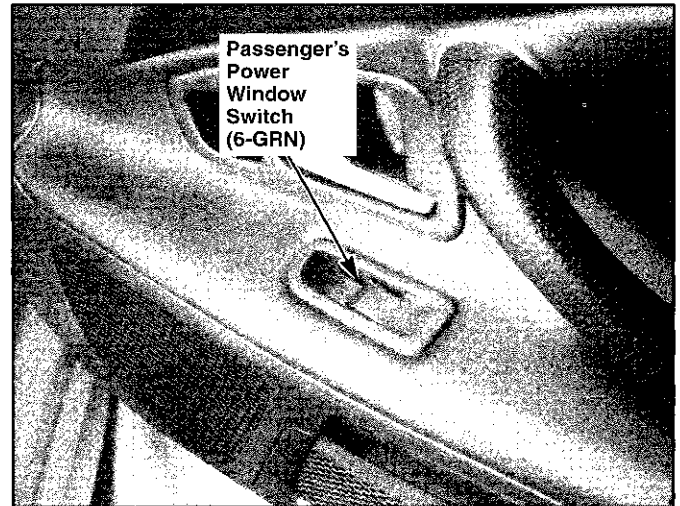

104. Under Driver's Roll Bar (Removable Hardtop)



107. Passenger's Door

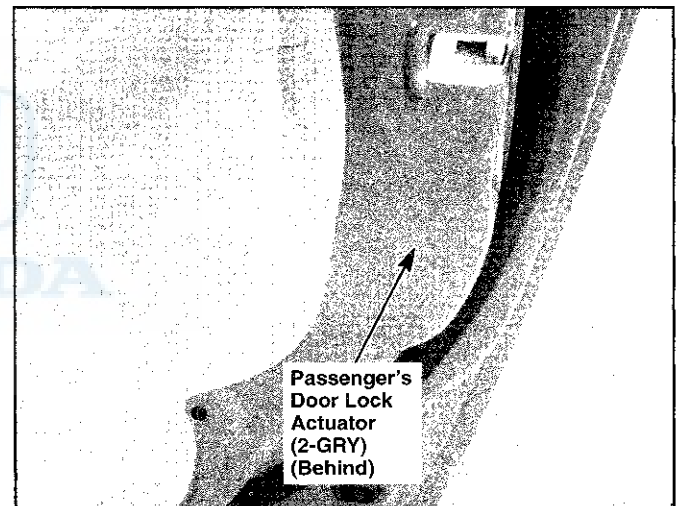

105. Behind Driver's Roll Bar (Passenger's Similar)

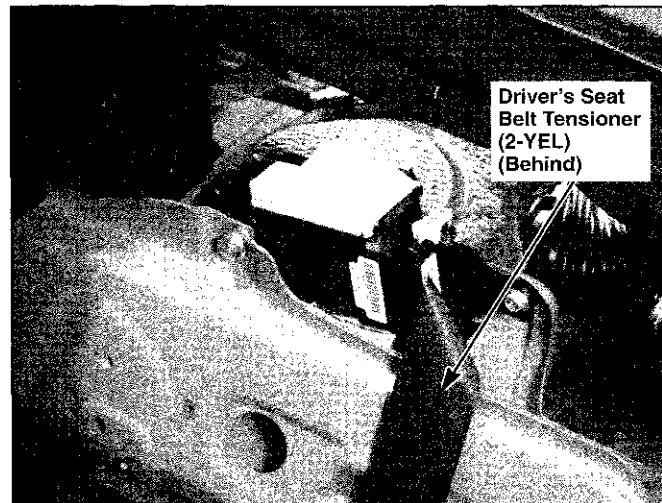

108. Under Passenger's Roll Bar (USA: Base, CR Audio – A/C; Canada)

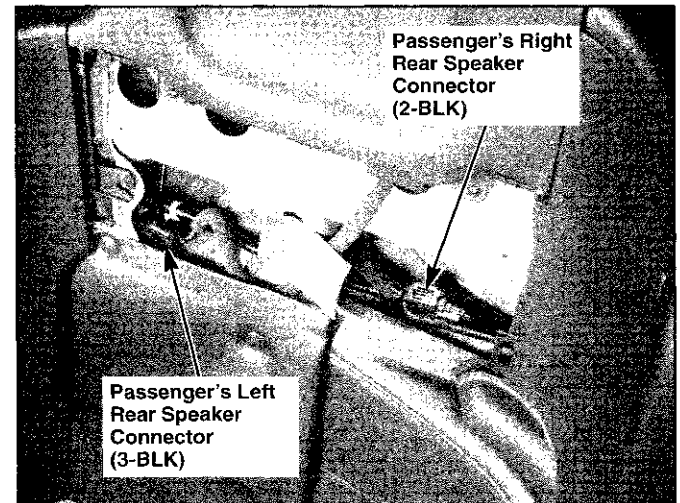

# Component Location

109. Center of Front Roof Rail Trim

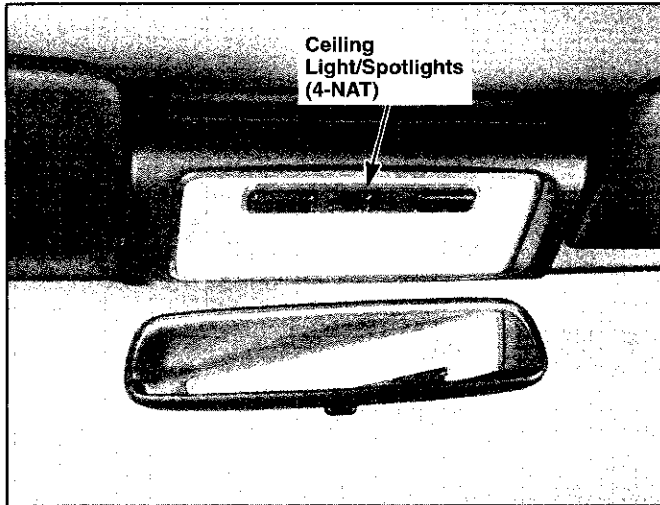

112. Left Side of Softtop (Softtop)

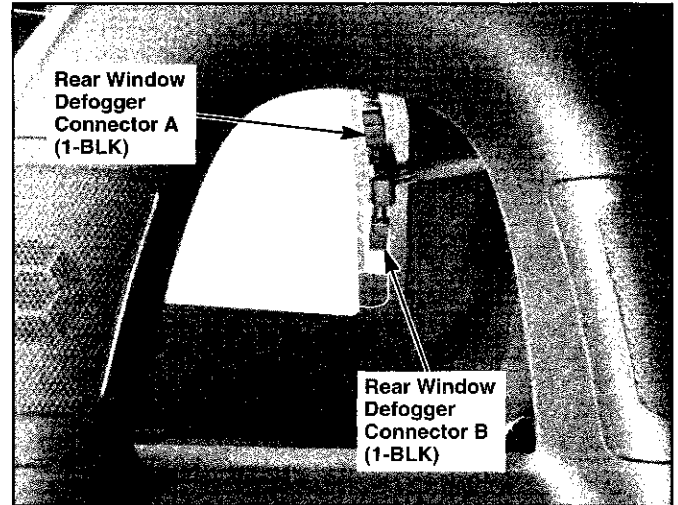

110. Left Side of Hardtop (Removable Hardtop)

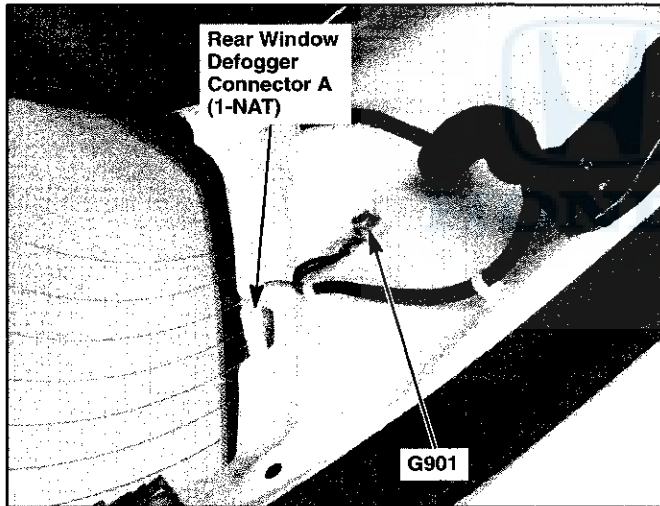

113. Under Driver's Seat

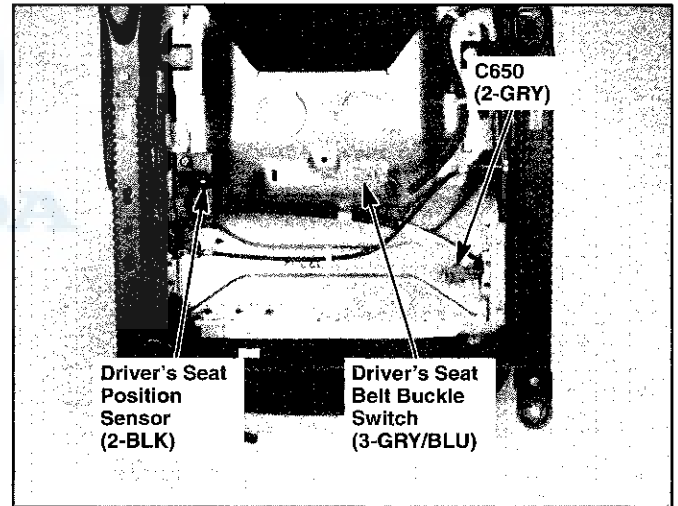

111. Right Side of Hardtop (Removable Hardtop)

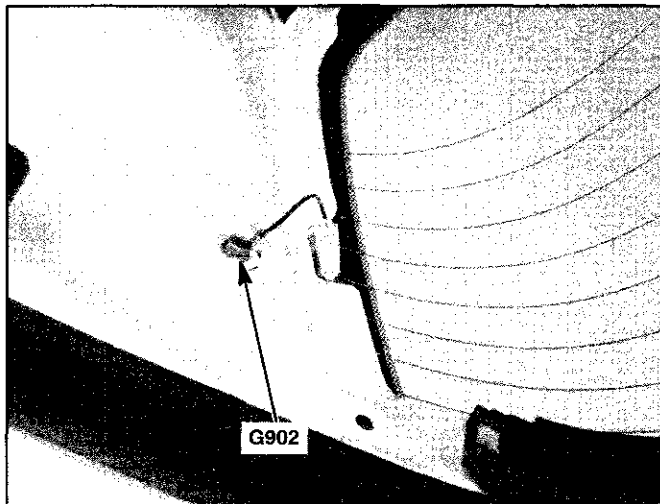

114. Under Passenger's Seat

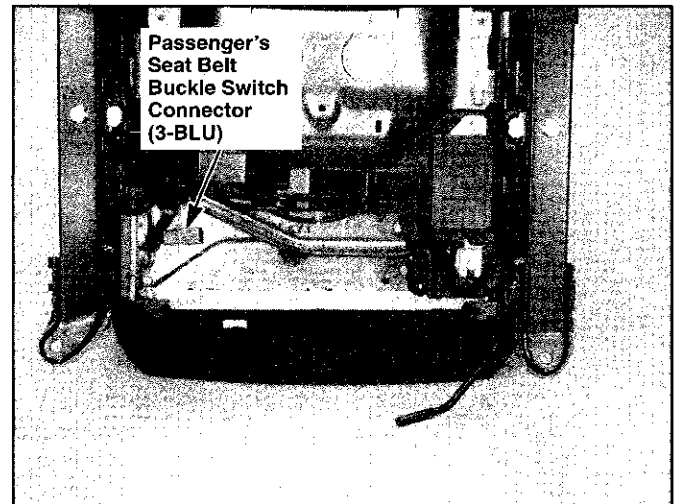





115. Under Passenger's Seat

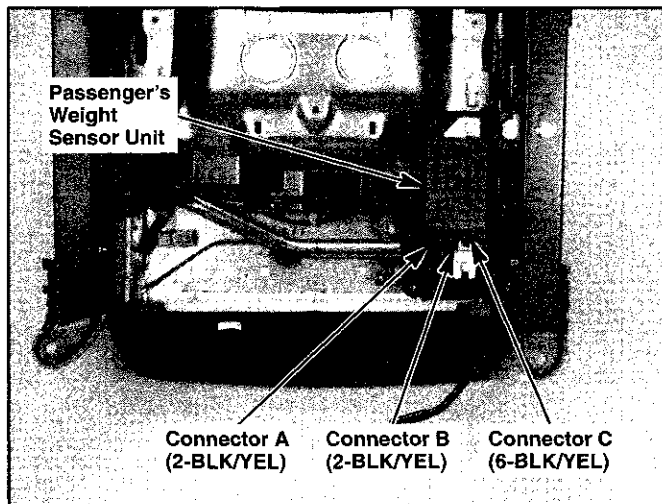

118. Left Side of Trunk (Right Similar)

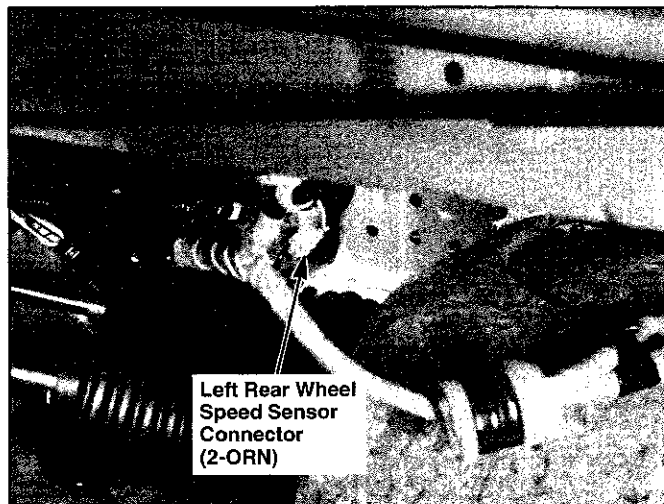

116. Left Side of Trunk

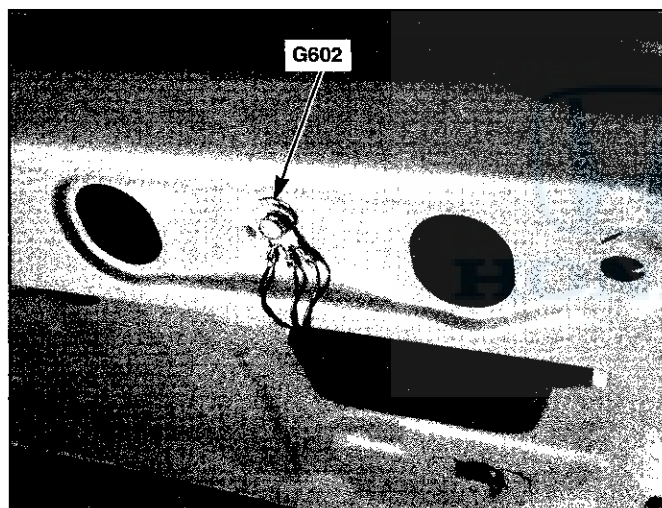

119. Left Side of Trunk (USA)

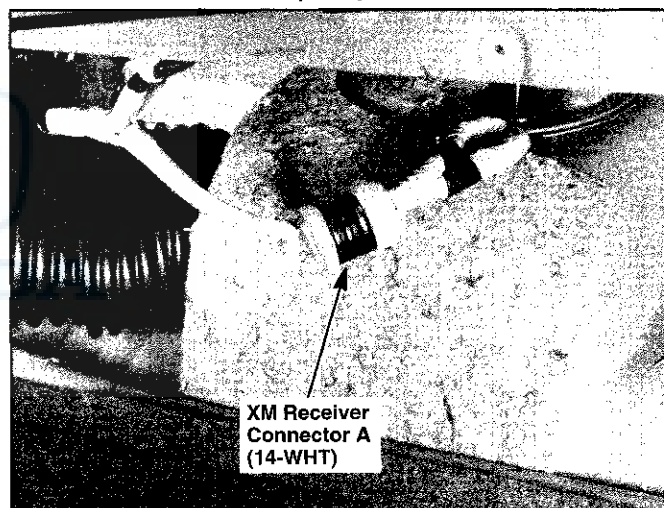

117. Left Side of Trunk

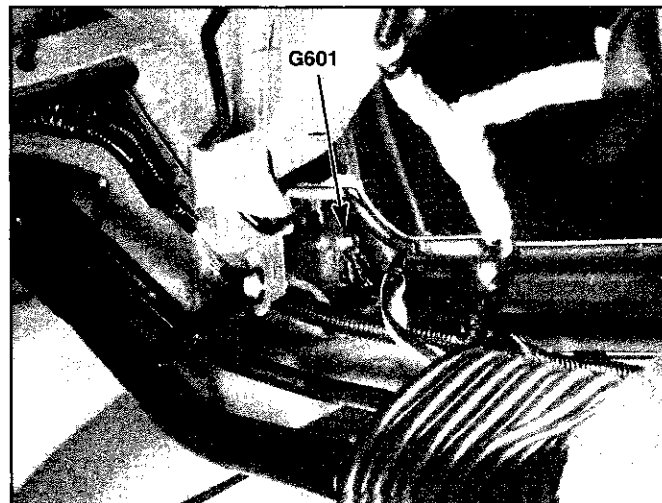

120. Left Side of Trunk (USA: Base; Canada)

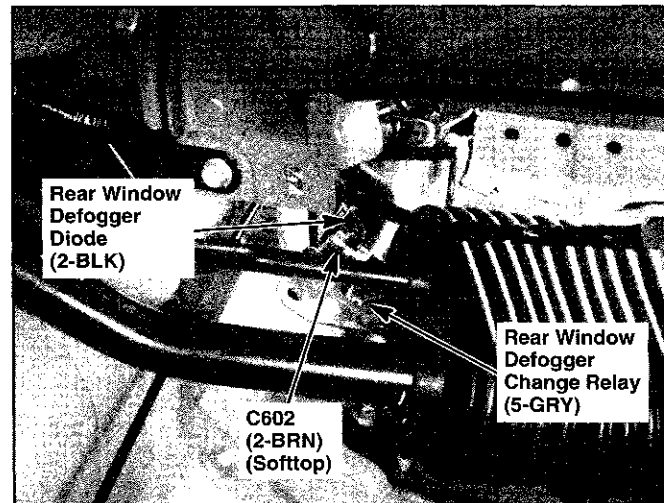

# Component Location

121. Left Side of Trunk

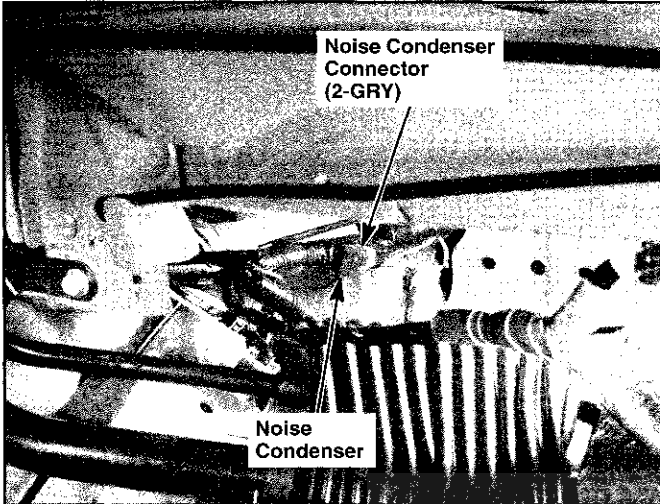

124. Middle of Fuel Tank

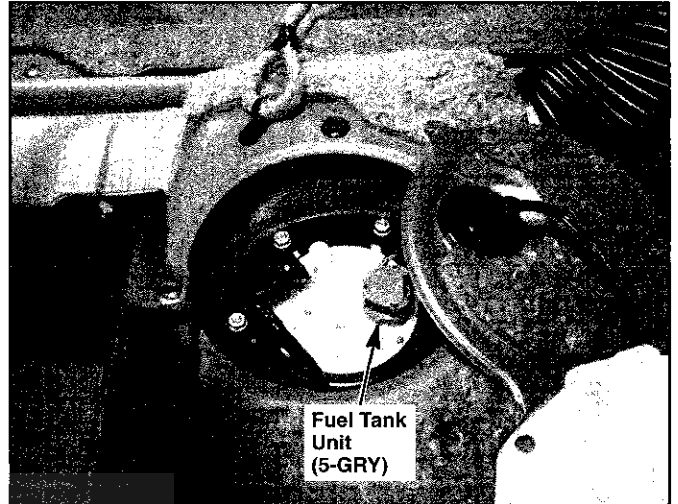

122. Behind Left Tailgate Assembly (Right Similar)

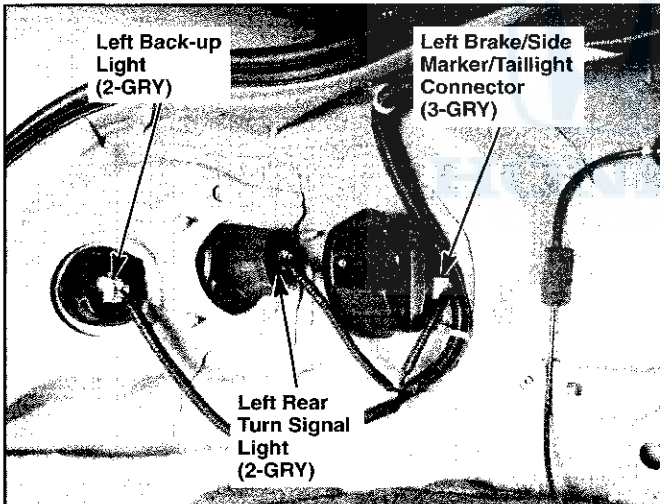

125. Middle of Trunk Lid

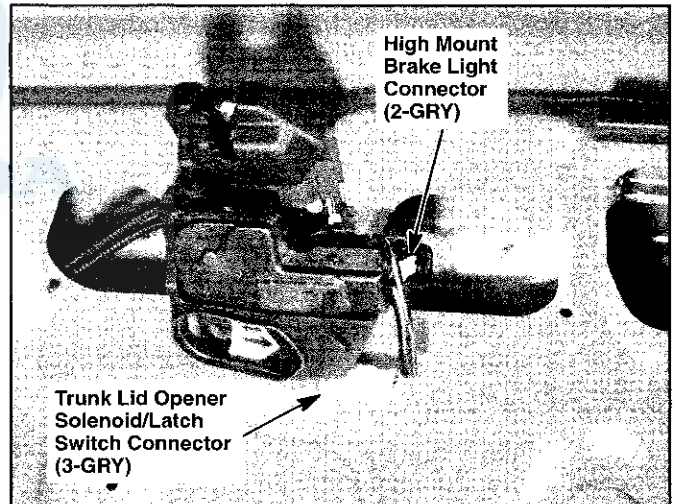

123. Upper Middle of Trunk

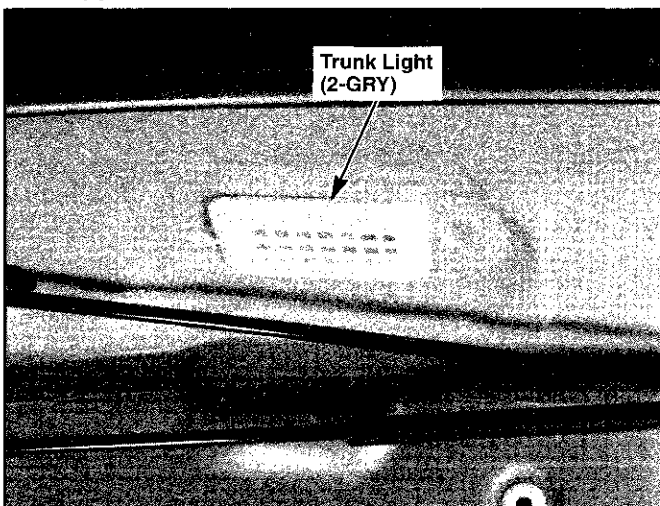

126. Right Side of Trunk

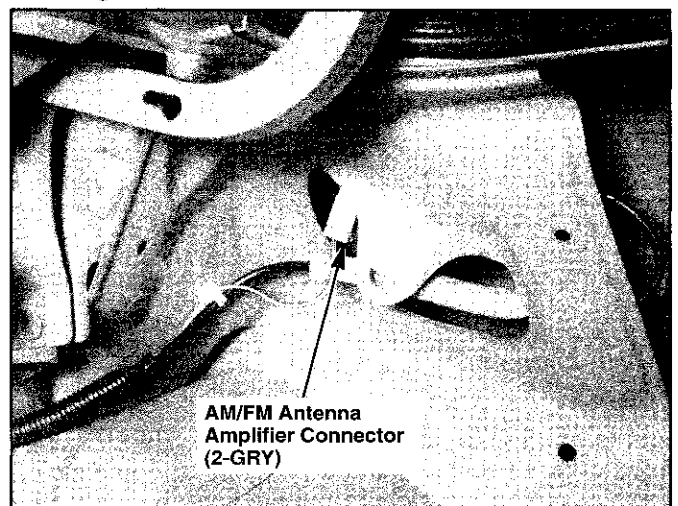



127. Center of Rear Bumper

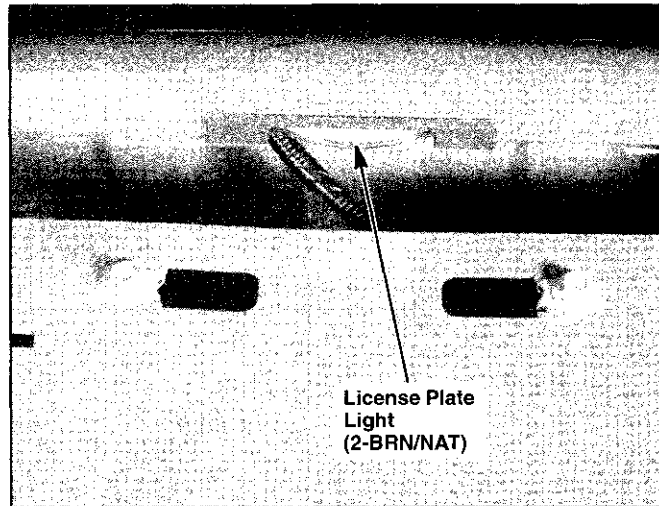

128. Under Left Side of Dash

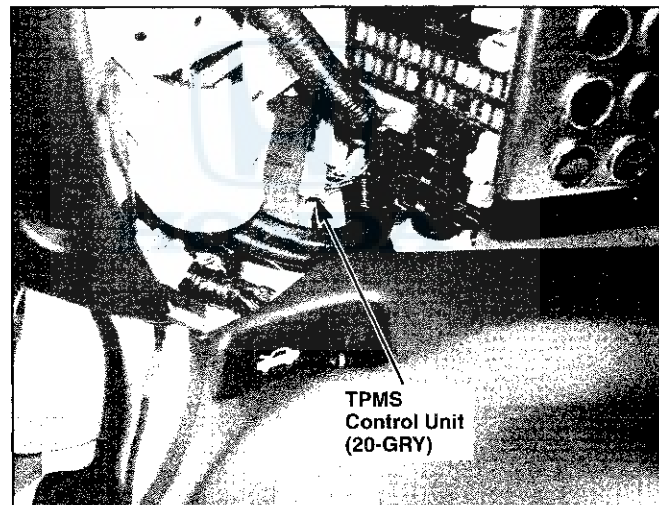

129. Under Right Side of Dash

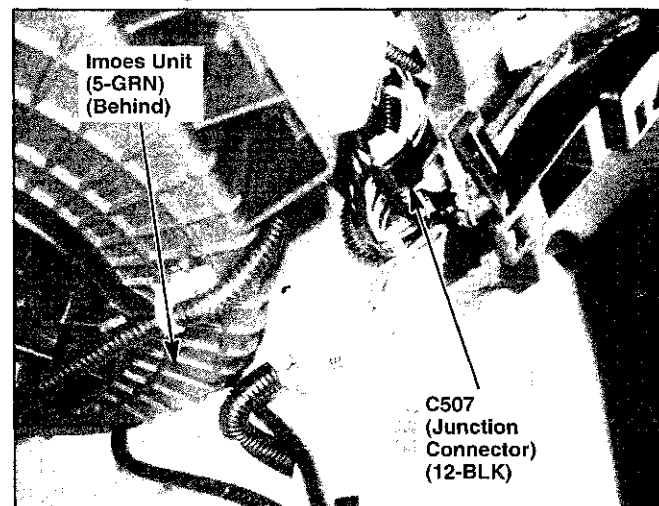

# Connector Terminal Views

## 1. A/C Compressor (USA: Base, CR Audio – A/C; Canada)

- GRY
- Left side of engine
- On engine wire harness



1 Male – RED  
Female – BLK/RED  
(Compressor clutch control (+))

## 2. Door Switch, Driver's or Passenger's

- NAT
- Behind left or right side rear trim
- On rear wire harness (left branch or right branch)



### Driver's:

1 GRN (Driver's door switch output (-))

### Passenger's:

1 LT GRN/RED (Passenger's door switch output (-))

## 3. Horn, High

- BLK
- Right side of engine compartment
- On right engine compartment wire harness



1 BLU/RED  
(Horn control (+))

## 4. Horn, Low

- BLK
- Behind center of front bumper
- On right engine compartment wire harness



1 BLU/RED (Horn control (+))

## 5. Horn Switch

- BLK
- Inside of steering wheel
- On cable reel assembly



1 BRN (Horns)

## 6. Knock Sensor

- BLK
- Left side of engine
- On engine wire harness



1 RED/BLU (Sensor output)





**7. Rear Window Defogger  
(Removable Hardtop)  
(USA: CR, CR Audio – A/C)**

– NAT



**Connector A**

– Left side of hardtop  
– On hardtop wire harness

1 BRN (Rear window defogger (+))

**Connector B**

– Right side of hardtop  
– On rear window defogger ground wire

1 BLK/RED (G902)

**8. Rear Window Defogger  
(Softtop) (USA: Base; Canada)**

– BLK  
– Left side of softtop  
– On rear window defogger sub-harness



**Connector A**

1 BLK  
(Rear window defogger (+))

**Connector B**

1 BLK (G601)

**9. Rocker Arm Oil Control  
Solenoid (VTEC Solenoid  
Valve)**

– GRY  
– Right side of engine  
– On engine wire harness



1 Male – GRN/WHT  
Female – GRN/YEL  
(Valve control (VTS))

**10. Starter Solenoid**

– BLK  
– Left side of engine  
– On engine wire harness



1 BLK/WHT  
(Starter solenoid control (+))

**11. A/C Condenser Fan Motor  
(USA: Base, CR Audio – A/C;  
Canada)**

– GRY  
– Left side of engine compartment  
– On right engine compartment wire harness



1 BLK (G201)  
2 Male – BLU/BLK  
Female – BLU/YEL  
(Fuse 58)

**12. A/C Pressure Switch (USA:  
Base, CR Audio – A/C;  
Canada)**

– GRY  
– Behind center of front bumper  
– On right engine compartment wire harness

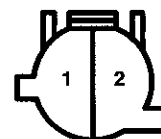

1 BLU/WHT (A/C ON input)  
2 BLU/RED (A/C pressure switch output)

# Connector Terminal Views

## 13. Accessory Power Socket

- BLK
- Behind rear of console
- On rear wire harness (right branch)

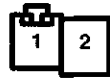

- 1 USA: Base; Canada: WHT/RED  
USA: CR, CR Audio - A/C: WHT  
(Fuse 9)
- 2 BLK (G601)

## 16. Back-up Light Switch

- GRY
- Left side of transmission
- On engine wire harness



- 1 Male - GRN/BLK  
Female - GRN/YEL  
(Switch output)
- 2 Male - GRN/BLK  
Female - YEL  
(Fuse 5)

## 14. AM/FM Antenna Amplifier

- GRY
- Right side of trunk
- On antenna amplifier sub-harness

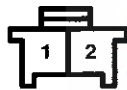

- 1 -
- 2 Male - YEL  
Female - GRN/YEL  
(Audio ON signal)

## 17. Blower Motor

- NAT
- Under right side of dash
- On dashboard wire harness B (right branch)

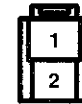

- 1 BLU/WHT (HVAC circuit)
- 2 BLU/BLK (Power transistor)

## 15. Back-up Light, Left or Right

- GRY
- Behind left or right taillight assembly
- On rear wire harness (left branch or right branch)

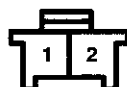

### Left:

- 1 BLK (G602)
- 2 GRN/BLK  
(Back-up light control  
input)

### Right:

- 1 BLK (G602)
- 2 GRN/BLK  
(Back-up light control  
input)

## 18. Brake Fluid Level Switch

- GRY
- Left side of engine compartment
- On left engine compartment wire harness



- 1 BLK (G301)
- 2 GRN/RED (Switch output (-))



## 19. Clutch Interlock Switch

- YEL
- Under left side of dash
- On dashboard wire harness B (left branch)



- 1 BLK (G401)
- 2 LT BLU  
(Clutch interlock switch output (-))

## 22. Convertible Top Motor Emergency Connector (USA: Base; Canada)

- GRY
- Under right side of dash
- On dashboard wire harness B (right branch)

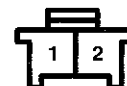

- 1 RED (Left convertible top motor)
- 2 LT GRN/RED (Right convertible top motor)

## 20. Clutch Pedal Position Switch

- NAT
- Under left side of dash
- On dashboard wire harness B (left branch)



- 1 BLK (G401)
- 2 PNK (Clutch switch output (-))

## 23. Convertible Top Motor, Left or Right (USA: Base; Canada)

- BRN
- Behind left or right side rear trim
- On rear wire harness (left branch or right branch)



### Left:

- 1 RED  
(Softtop close (+))
- 2 Male - YEL  
Female - RED/BLU  
(Softtop open (+))

### Right:

- 1 Male - RED  
Female - RED/WHT  
(Softtop open (+))
- 2 Male - YEL  
Female - LT GRN/RED  
(Softtop close (+))

## 21. Convertible Top Disable Switch (Removable Hardtop) (USA: CR, CR Audio - A/C)

- GRY
- Under driver's roll bar
- On hardtop sub-harness

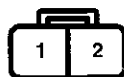

- 1 Male - GRN/YEL  
Female - LT GRN  
(Switch output)
- 2 BLK (G601)

## 24. Door Key Cylinder Switch, Driver's

- GRY
- Driver's door
- On driver's door wire harness



- 1 Male - WHT  
Female - BLK/RED  
(Switch output (-))
- 2 BLK (G501)

## Connector Terminal Views

### 25. Door Lock Actuator, Passenger's

- GRY
- Passenger's door
- On passenger's door wire harness



- 1 PNK/BLK (Lock signal (+))
- 2 PNK/BLU (Unlock signal (+))

### 28. ECT Sensor 1

- BLK
- Rear of engine
- On engine wire harness



- 1 RED/WHT (ECT1)
- 2 GRN/YEL (Ground for ECM sensors (SG2) circuit)

### 26. Driver's Seat Position Sensor

- BLK
- Under driver's seat
- On rear wire harness (left branch)



- 1 WHT (SRS)
- 2 BLK (SRS)

### 29. ECT Sensor 2

- BLK
- Left side of engine compartment
- On left engine compartment wire harness



- 1 BLU (ECT2)
- 2 GRN (Ground for ECM sensors (SG3) circuit)

### 27. DRL Diode 1

- BLK
- Under middle of dash
- On dashboard wire harness B (right branch)

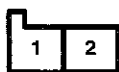

- 1 BLU (High beam cut relay power supply)
- 2 RED/YEL (Fuse 45)

### 30. EPS Motor

- GRY
- Engine compartment (below front beam)
- On right engine compartment wire harness



- 1 RED (Motor control (+))
- 2 GRN (Motor control (-))



### 31. EVAP Canister Purge Valve

- BLK
- Left side of engine compartment
- On left engine compartment wire harness



- 1 BLK/YEL (Fuse 6)
- 2 RED/YEL (Valve control input (PCS))

### 34. Headlight (Low Beam), Left or Right

- GRY
- Behind left or right headlight
- On left or right engine compartment wire harness



#### Left:

- 1 BLK (G501)
- 2 Male - RED  
Female - RED/YEL  
(Fuse 45)

#### Right:

- 1 BLK (G501)
- 2 Male - RED  
Female - RED/WHT  
(Fuse 43)

### 32. EVAP Canister Vent Shut Valve

- BLK
- Under left side of floor
- On rear wire harness (left branch)



- 1 LT GRN/WHT (Valve control input (VSV))
- 2 WHT (Power source for ECM sensors circuit)

### 35. High Mount Brake Light

- GRY
- Middle of trunk lid
- On rear wire harness (left branch)



- 1 WHT/BLK (Brake pedal position circuit)
- 2 BLK (G601)

### 33. Evaporator Temperature Sensor (USA: Base, CR Audio - A/C; Canada)

- GRY
- Under right side of dash
- On dashboard wire harness B (right branch)



- 1 Male - BLK  
Female - LT GRN  
(Sensor ground (SCOM))
- 2 Male - BLK  
Female - BRN  
(Sensor output)

### 36. IAT Sensor

- BLK
- Middle of engine
- On left engine compartment wire harness



- 1 RED/YEL (PGM-FI system)
- 2 GRN (Ground for ECM sensors (SG3) circuit)

# Connector Terminal Views

## 37. Impact Sensor, Left Front

- YEL
- Left side of engine compartment
- On left engine compartment wire harness

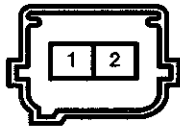

- 1 RED or BRN (SRS)
- 2 BRN (SRS)

## 40. License Plate Light

- BRN/NAT
- Center of rear bumper
- On rear wire harness (right branch)

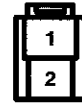

- 1 RED/BLK (Illumination (positive) circuit)
- 2 BLK (G602)

## 38. Impact Sensor, Right Front

- YEL
- Right side of engine compartment
- On right engine compartment wire harness



- 1 GRN or BLU (SRS)
- 2 LT BLU or BLU (SRS)

## 41. MES Connector

- YEL
- Under left side of dash
- On SRS main wire harness



- 1 LT GRN/BLK or BLU (SRS)
- 2 BLK or BLU (G501)

## 39. Injectors

- BLU
- Middle of engine
- On engine wire harness

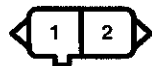

### No. 1:

- 1 BRN (Control (INJ1))
- 2 YEL/BLK (Power source for ECM circuit)

### No. 2:

- 1 RED (Control (INJ2))
- 2 YEL/BLK (Power source for ECM circuit)

### No. 3:

- 1 BLU (Control (INJ3))
- 2 YEL/BLK (Power source for ECM circuit)

### No. 4:

- 1 YEL (Control (INJ4))
- 2 YEL/BLK (Power source for ECM circuit)

## 42. Noise Condenser

- GRY
- Left side of trunk
- On rear wire harness (left branch)



- 1 BLK/RED (Power)
- 2 BLK (G601)



### 43. Outside Air Temperature Sensor

- GRY
- Behind center of front bumper
- On right engine compartment wire harness



- 1 PNK (Gauges and indicators)
- 2 BLK (Gauges and indicators)

### 46. Radiator Fan Motor

- GRY
- Right side of engine compartment
- On right engine compartment wire harness



- 1 BLK (G201)
- 2 Male - BLU  
Female - BLU/BLK  
(Radiator fan control input)

### 44. Parking Brake Switch

- GRY
- Below center of console
- On dashboard wire harness B (right branch)



- 1 Male - BLK  
Female - GRN/WHT  
(Parking brake switch output (-))
- 2 -

### 47. Rear Window Defogger Diode (USA: Base; Canada)

- BLK
- Left side of trunk
- On rear wire harness (left branch)

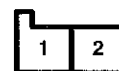

- 1 LT GRN (Hardtop installed input)
- 2 LT GRN/WHT (Hardtop defogger control)

### 45. Parking/Side Marker Light, Left Front or Right Front

- BRN/NAT
- Behind left or right headlight
- On left or right engine compartment wire harness

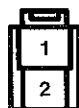

#### Left Front:

- 1 BLK (G301)
- 2 RED/BLK (Illumination (positive) circuit)

#### Right Front:

- 1 BLK (G201)
- 2 RED/BLK (Illumination (positive) circuit)

### 48. Rocker Arm Oil Pressure Switch (VTEC Oil Pressure Switch)

- GRY
- Right side of engine
- On engine wire harness

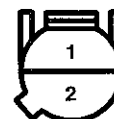

- 1 BLU/BLK (Switch output (-))
- 2 BRN/YEL (G101)

# Connector Terminal Views

## 49. Seat Belt Tensioner, Driver's or Passenger's

- YEL
- Behind driver's or passenger's roll bar
- On SRS main wire harness

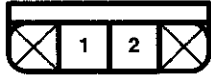

### Driver's:

- 1 Male - RED  
Female - BRN or BLU (SRS)
- 2 Male - BLK  
Female - RED or BLU (SRS)

### Passenger's:

- 1 Male - RED  
Female - LT BLU or BLU (SRS)
- 2 Male - BLK  
Female - GRN or BLU (SRS)

## 50. Security Hood Switch (Honda Accessory)

- GRY
- Front of engine compartment
- On hood switch harness (Honda Accessory)



- 1 BLK (G51)
- 2 YEL/RED  
(Switch output (-))

## 51. Security In-line Fuse 1 (Honda Accessory)

- NAT
- Under left side of dash
- On security system harness (Honda Accessory)

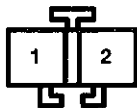

- 1 WHT (Fuse 26)
- 2 WHT/BLU (Security system)

## 52. Security In-line Fuse 2 (Honda Accessory)

- NAT
- Under left side of dash
- On security system harness (Honda Accessory)

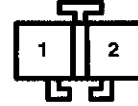

- 1 YEL (Fuse 5)
- 2 YEL/BLU (Security system)

## 53. Speaker, Driver's Door or Passenger's Door (USA: Base, CR Audio - A/C; Canada)

- GRY
- Driver's door or passenger's door
- On driver's or passenger's door wire harness



### Driver's Door:

- 1 GRY/RED (Audio (-))
- 2 GRN/YEL (Audio (+))

### Passenger's Door:

- 1 LT GRN (Audio (-))
- 2 GRN/BLK (Audio (+))





### 54. Speaker, Driver's Left Rear (USA: Base, CR Audio – A/C; Canada)

- BLK
- Under driver's roll bar
- On rear wire harness (left branch)



- 1 Male – BLU/YEL  
Female – RED  
(Audio system)
- 2 Male – GRY/RED  
Female – BLK  
(Audio system)

### 55. Speaker, Passenger's Right Rear (USA: Base, CR Audio – A/C; Canada)

- BLK
- Under passenger's roll bar
- On rear wire harness (right branch)



- 1 Male – RED/YEL  
Female – RED  
(Audio system)
- 2 Male – BRN/WHT  
Female – BLK  
(Audio system)

### 56. Test Tachometer Connector

- BLK
- Left side of engine compartment
- On left engine compartment wire harness

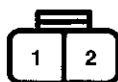

- 1 —
- 2 BLU (Tachometer signal)

### 57. Trunk Lid Opener Switch

- NAT
- Behind rear of console
- On rear wire harness (left branch)



- 1 BLK/YEL  
(Trunk lid opener switch output (+))
- 2 WHT (Fuse 26)

### 58. Trunk Light

- GRY
- Upper middle of trunk
- On rear wire harness (left branch)

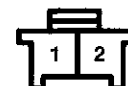

- 1 WHT/BLU (Fuse 24)
- 2 BLU/BLK  
(Trunk lid position circuit – Latch switch output)

### 59. Turn Signal Light, Left Front or Right Front

- GRY
- Behind left or right headlight
- On left or right engine compartment wire harness



#### Left Front:

- 1 BLK (G301)
- 2 GRN/RED (Left turn signal control (+))

#### Right Front:

- 1 BLK (G201)
- 2 GRN/YEL (Right turn signal control (+))

## Connector Terminal Views

### 60. Turn Signal Light, Left Rear or Right Rear

- GRY
- Behind left or right taillight assembly
- On rear wire harness (left branch or right branch)



#### Left Rear:

- 1 BLK (G602)
- 2 GRN/RED  
(Turn signal control (+))

#### Right Rear:

- 1 BLK (G602)
- 2 GRN/YEL  
(Turn signal control (+))

### 61. Turn Signal Light, Left Side or Right Side

- BRN/NAT
- Behind left or right fender
- On left or right engine compartment wire harness

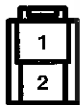

#### Left Side:

- 1 BLK (G301)
- 2 GRN/RED  
(Turn signal input (+))

#### Right Side:

- 1 BLK (G201)
- 2 GRN/YEL  
(Turn signal input (+))

### 62. Tweeter, Left or Right (USA: Base, CR Audio - A/C; Canada)

- GRY
- Driver's or passenger's door
- On driver's or passenger's door wire harness



#### Left:

- 1 Male - GRY/RED  
Female - BLK  
(Audio (-))
- 2 Male - GRN/YEL  
Female - RED  
(Audio (+))

#### Right:

- 1 Male - LT GRN  
Female - BLK  
(Audio (-))
- 2 Male - GRN/BLK  
Female - RED  
(Audio (+))

### 63. Wheel Speed Sensor, Left Front

- ORN
- Left side of engine compartment
- On left engine compartment wire harness

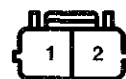

- 1 Male - BLU/ORN  
Female - RED  
(FLW (+))
- 2 Male - BRN/WHT  
Female - WHT  
(FLW (-))

### 64. Wheel Speed Sensor, Left Rear

- ORN
- Left side of trunk
- On rear wire harness (left branch)



- 1 Male - YEL/RED  
Female - RED  
(RLW (+))
- 2 Male - GRY/RED  
Female - WHT  
(RLW (-))

### 65. Wheel Speed Sensor, Right Front

- ORN
- Right side of engine compartment
- On right engine compartment wire harness



- 1 Male - GRN/BLK  
Female - RED  
(FRW (+))
- 2 Male - BLU  
Female - WHT  
(FRW (-))



## 66. Wheel Speed Sensor, Right Rear

- ORN
- Right side of trunk
- On rear wire harness (right branch)



- 1 Male - GRN/WHT  
Female - RED  
(RRW (-))
- 2 Male - BLU/YEL  
Female - WHT  
(RRW (+))

## 69. C351

- GRY
- Left side of engine compartment
- Connects EPS sub-harness to left engine compartment wire harness



- 1 -
- 2 WHT/RED (Fuse 33)

## 67. Power Window Motor, Passenger's

- GRY
- Passenger's door
- On passenger's door wire harness



- 1 Male - BLU/WHT  
Female - RED/BLU  
(Window UP input (+))
- 2 Male - BLU/RED  
Female - RED  
(Window DOWN input (+))

## 70. C452

- GRY
- Under right side of dash
- Connects dashboard wire harness B (right branch) to roof wire harness

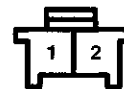

- 1 GRN/YEL (Interior light)
- 2 WHT/BLU (Fuse 24)

## 68. Windshield Washer Motor

- BRN/NAT
- Behind right front wheel well
- On right engine compartment wire harness

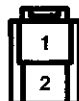

- 1 WHT/BLK  
(Washer motor control input (+))
- 2 BLK (G201)

## 71. C551 (USA: Base, CR Audio - A/C; Canada)

- GRY
- Behind lower center of dash
- Connects dashboard wire harness A to antenna amplifier sub-harness



- 1 -
- 2 Male - YEL/GRN  
Female - GRN/YEL  
(Audio system)

## Connector Terminal Views

### 72. C602 (Softtop) (USA: Base; Canada)

- BRN
- Left side of trunk
- Connects rear wire harness (left branch) to rear window defogger sub-harness (softtop)

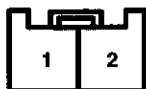

- 1 BLK (Rear defogger)
- 2 BLK (G601)

### 75. CMP Sensor

- BLK
- Rear of engine
- Engine wire harness



- 1 GRN (Sensor output (CMP))
- 2 BRN/YEL (G101)
- 3 YEL/BLK (Power source for ECM circuit)

### 73. Brake Light/Side Marker/Taillight, Left or Right

- GRY
- Behind left or right taillight assembly
- On rear wire harness (left branch or right branch)

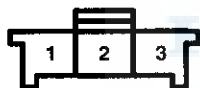

#### Left:

- 1 WHT/BLK (Brake pedal position circuit)
- 2 RED/BLK (Illumination (positive) circuit)
- 3 BLK (G602)

#### Right:

- 1 WHT/BLK (Brake pedal position circuit)
- 2 RED/BLK (Illumination (positive) circuit)
- 3 BLK (G602)

### 76. DRL Diode 2 (USA)

- WHT
- Under middle of dash
- On dashboard wire harness B (right branch)

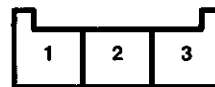

- 1 RED/ORN (Headlights)
- 2 YEL (Headlights)
- 3 RED/BLU (Headlights)

### 74. CKP Sensor

- GRY or BLK
- Front of engine
- On CKP sensor sub-harness



- 1 BLU (Sensor output (CKP))
- 2 BRN/YEL (G101)
- 3 YEL/BLK (Power source for ECM circuit)

### 77. ELD Unit

- GRY
- Right side of engine compartment
- On right engine compartment wire harness

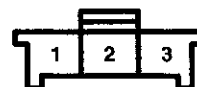

- 1 BLK/YEL (Ignition input)
- 2 BLK (G201)
- 3 GRN/RED (ELD output)



## 78. EPS Torque Sensor

- GRY
- Left side of engine compartment
- On right engine compartment wire harness

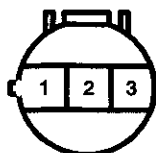

- 1 PNK (Voltage sensor 1 output)
- 2 BLU/RED (Torque sensor power)
- 3 WHT/GRN (Voltage sensor 2 output)

## 79. FTP Sensor

- BLK
- Under left side of floor
- On rear wire harness (left branch)



- 1 YEL/BLU (Reference voltage for ECM sensors (VCC3) circuit)
- 2 LT GRN (Sensor output (FTP))
- 3 GRN (Ground for ECM sensors (SG3) circuit)

## 80. Headlight (High Beam), Left or Right

- BLK
- Behind left or right headlight
- On left or right engine compartment wire harness

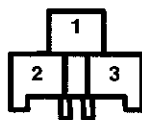

### Left:

- 1 —
- 2 RED/WHT (High beam control (+))
- 3 RED/BLU (High beam control (-))

### Right:

- 1 —
- 2 RED/ORN (High beam control (+))
- 3 RED/BLU (High beam control (-))

## 81. Ignition Coils

- BLU
- Middle of engine
- On engine wire harness

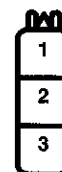

### No. 1:

- 1 WHT (Coil control (IGPLS1))
- 2 BLK (G101)
- 3 BLK/YEL (Fuse 16)

### No. 3:

- 1 WHT/BLK (Coil control (IGPLS3))
- 2 BLK (G101)
- 3 BLK/YEL (Fuse 16)

### No. 2:

- 1 WHT/GRN (Coil control (IGPLS2))
- 2 BLK (G101)
- 3 BLK/YEL (Fuse 16)

### No. 4:

- 1 WHT/BLU (Coil control (IGPLS4))
- 2 BLK (G101)
- 3 BLK/YEL (Fuse 16)

## 82. MAP Sensor

- BLK
- Left side of engine
- On engine wire harness



- 1 YEL/RED (Reference voltage (VCC1))
- 2 GRN/RED (Sensor output (MAP))
- 3 GRN/WHT (Sensor ground (SG1))

# Connector Terminal Views

## 83. Output Shaft (Countershaft) Speed Sensor

- BLK
- Left side of transmission
- On engine wire harness



- 1 YEL/BLU  
(Reference voltage for ECM sensors (VCC2) circuit)
- 2 BLU/WHT (Vehicle speed sensor signal 2 circuit)
- 3 GRN/YEL (Ground for ECM sensors (SG2) circuit)

## 85. Seat Belt Buckle Switch, Driver's

- GRY/BLU
- Under driver's seat
- On rear wire harness (left branch)



- 1 BLK (G601)
- 2 Male - RED  
Female - YEL (BSDL)
- 3 Male - GRN  
Female - LT GRN (BSDH)

## 86. Seat Belt Buckle Switch, Passenger's

- BLU
- Under passenger's seat
- On rear wire harness (right branch)

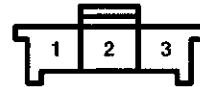

- 1 Male - GRN  
Female - BLK (G601)
- 2 Male - RED  
Female - BLU (BSPL)
- 3 Male - BLK  
Female - ORN (BSPH)

## 84. Power Mirror, Left or Right

- GRY
- Driver's door or passenger's door
- On driver's or passenger's door wire harness

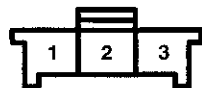

### Left:

- 1 Male - YEL  
Female - RED  
(Left/Right control)
- 2 Male - BRN, BRN  
Female - RED/YEL  
(Common)
- 3 Male - BLU  
Female - GRN/WHT  
(Up/Down control)

### Right:

- 1 Male - YEL  
Female - BLU/WHT  
(Left/Right control)
- 2 Male - BRN, BRN  
Female - RED/BLU  
(Common)
- 3 Male - BLU  
Female - GRN/WHT  
(Up/Down control)

## 87. Security Disarm Switch (Honda Accessory)

- GRY
- Lower left dashboard
- On security system harness (Honda Accessory)

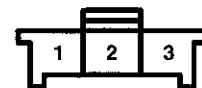

- 1 BLU (Switch output (-))
- 2 -
- 3 BLK (G501)



### 88. Speaker, Driver's Right Rear (USA: Base, CR Audio – A/C; Canada)

- BLK
- Under driver's roll bar
- On rear wire harness (right branch)

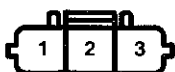

- 1 Male – RED/YEL  
Female – WHT  
(Audio system)
- 2 –
- 3 Male – BRN/WHT  
Female – BLK  
(Audio system)

### 91. C105

- BLK
- Middle of engine
- Connects engine wire harness to CKP sensor sub-harness



- 1 BLU (PGM-FI system)
- 2 BRN/YEL (G101)
- 3 YEL/BLK (Power source for ECM circuit)

### 89. Speaker, Passenger's Left Rear (USA: Base, CR Audio – A/C; Canada)

- BLK
- Under passenger's roll bar
- On rear wire harness (left branch)



- 1 Male – BLU/YEL  
Female – WHT  
(Audio system)
- 2 –
- 3 Male – GRY/RED  
Female – BLK  
(Audio system)

### 92. C601

- GRY
- Under driver's roll bar
- Connects rear wire harness (left branch) to hardtop sub-harness (removable hardtop)

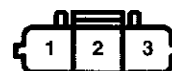

- 1 USA: Base; Canada: LT GRN (Convertible top)
- 2 USA: Base; Canada: Male – BRN  
Female – BLK/RED  
(Rear window defogger)  
USA: CR, CR Audio – A/C: Male – BLK/RED  
(Not used)
- 3 BLK (G601)

### 90. Trunk Lid Opener Solenoid/Latch Switch

- GRY
- Middle of trunk lid
- On rear wire harness (left branch)

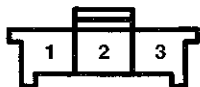

- 1 Male – BLU  
Female – BLK/YEL  
(Trunk lid opener control (+))
- 2 BLK (G601)
- 3 Male – BRN  
Female – BLU/BLK  
(Trunk lid position circuit)

### 93. C701

- GRY
- Steering wheel
- On cruise control set/resume/cancel switch sub-harness

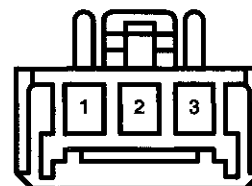

- 1 Male – BLK/RED or RED  
Female – RED (Set switch output (+))
- 2 Male – BLK/ORN or BLU  
Female – BLU (Resume switch output (+))
- 3 Male – BLK/WHT or BRN  
Female – BRN (Horn relay control circuit)

# Connector Terminal Views

## 94. C901 (Removable Hardtop) (USA: CR, CR Audio – A/C)

- BLK
- Behind left rear side trim
- Connects hardtop sub-harness to hardtop wire harness

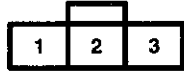

- |   |
|---|
| 1 Male – BLK/RED<br>Female – BRN<br>(Rear defogger control) |
| 2 —   |
| 3 BLK (G901)  |

## 97. Airbag First and Second Inflators, Passenger's

- YEL
- Under right side of dash
- On SRS main harness

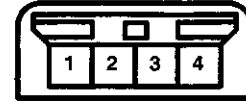

- |   |   |
|---|---|
| 1 Male – YEL<br>Female – BLU<br>(Passenger's first inflator)        | 3 Male – RED<br>Female – LT BLU or BLU<br>(Passenger's second inflator) |
| 2 Male – YEL<br>Female – YEL or BLU<br>(Passenger's first inflator) | 4 Male – RED<br>Female – LT GRN or BLU<br>(Passenger's second inflator) |

## 95. A/F Sensor

- GRY
- Left side of transmission
- On engine wire harness



- |   |  |
|---|--|
| 1 Male – BLU<br>Female – RED<br>(AFS (+))     | 3 Male – BLK<br>Female – WHT/BLK<br>(Power source for ECM sensors circuit) |
| 2 Male – WHT<br>Female – RED/YEL<br>(AFS (-)) | 4 Male – BLK<br>Female – GRN<br>(AFSHTC)                                   |

## 98. Alternator

- BLU
- Left side of engine
- On engine wire harness

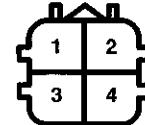

- |  |
|--|
| 1 BLK/YEL (Fuse 6)                           |
| 2 WHT/GRN (Alternator control signal (ALTC)) |
| 3 WHT/BLU (Alternator control signal (ALTL)) |
| 4 WHT/RED (Alternator FR signal (ALTF))      |

## 96. Airbag First and Second Inflators, Driver's

- YEL
- In steering wheel
- On cable reel assembly



- |  |   |
|--|---|
| 1 Male – RED<br>Female – YEL<br>(Driver's second inflator) | 3 Male – YEL<br>Female – GRN<br>(Driver's first inflator) |
| 2 Male – RED<br>Female – BLK<br>(Driver's second inflator) | 4 Male – YEL<br>Female – WHT<br>(Driver's first inflator) |

## 99. Brake Pedal Position Switch

- WHT
- Under left side of dash
- On dashboard wire harness B (left branch)

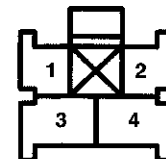

- |  |
|--|
| 1 LT GRN (Cruise control)                |
| 2 GRY (Cruise control)                   |
| 3 WHT/BLK (Brake pedal position circuit) |
| 4 WHT/GRN (Fuse 47)                      |





## 100. Ceiling Light/Spotlights

- NAT
- Center of front roof rail trim
- On roof wire harness

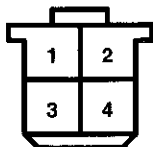

- |  |  |
|--|--|
| 1 WHT/BLU (Fuse 24)  | 3 Male - WHT/RED<br>Female - —<br>(Not used) |
| 2 Male - BLK/WHT<br>Female - GRN/YEL<br>(Controlled ground<br>(Keyless door lock<br>control unit)) | 4 Male - BLK/GRN<br>Female - —<br>(Not used) |

## 101. Cruise Control Set/Resume/Cancel Switch

- BLK
- Inside steering wheel
- On cruise control set/resume/cancel switch sub-harness

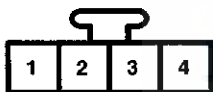

- |   |
|---|
| 1 BLK/RED or RED (Set switch output (+))      |
| 2 BLK/ORN or BLU (Resume switch output (+))   |
| 3 BLK/WHT or BRN (Horn relay control circuit) |
| 4 —   |

## 102. HO2S, Secondary

- GRY
- Left side of transmission
- On engine wire harness



- |   |   |
|---|---|
| 1 Male - GRN/YEL<br>Female - BLK or GRY<br>(Ground for ECM<br>sensors (SG2) circuit<br>(SG2)) | 3 Male - BLK/WHT<br>Female - WHT<br>(Heater control<br>(SO2SHTC)) |
| 2 Male - WHT<br>Female - GRY or BLK<br>(Sensor output (SHO2S))                                | 4 Male - BLK/YEL<br>Female - WHT<br>(Fuse 6)                      |

## 103. Ignition Coil Relay and A/F Sensor Relay

- BLK
- Under left side of dash
- On dashboard wire harness B (right branch)

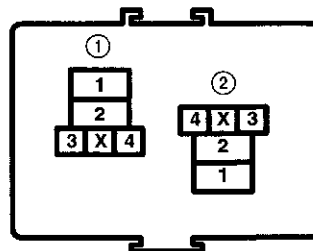

### ① Ignition Coil Relay:

- 1 BLK/YEL (Fuse 16)
- 2 GRN/YEL (Ignition system)
- 3 GRN (PGM-FI main relay 1 control circuit)
- 4 BLK/YEL (Fuse 16 - Under-dash)

### ② A/F Sensor Relay:

- 1 WHT/RED (Fuse 15)
- 2 WHT (Power source for ECM sensors circuit)
- 3 ORN (AFSHTCR)
- 4 YEL/BLU (Fuse 10 - Under-dash)

## 104. Imoes Unit

- GRN
- Under right side of dash
- On dashboard wire harness B (right branch)

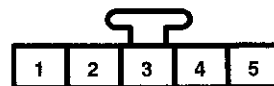

- 1 GRN/WHT (LG1)
- 2 RED/BLU (SNET)
- 3 BLK/YEL (IG1)
- 4 RED/WHT (KEYOUT)
- 5 WHT/RED (B+)

# Connector Terminal Views

## 105. Passenger's Airbag Cut-Off Indicator

- GRN
- Center of dash
- On dashboard wire harness A

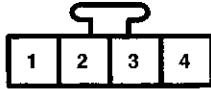

- 1 BLK/YEL (Fuse 2)
- 2 RED (Illumination (negative) circuit)
- 3 RED/BLK (Illumination (positive) circuit)
- 4 BLU (Indicator control)

## 108. Power Window Motor, Driver's

- GRY/LT GRN
- Driver's door
- On driver's door wire harness

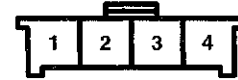

- |  |   |
|--|---|
| 1 Male - BLU/RED<br>Female - RED/YEL<br>(Down (+)) | 3 Male - YEL<br>Female - BLU<br>(Window position<br>pulse signal) |
| 2 Male - BLU/WHT<br>Female - RED/BLK<br>(Up (+))   | 4 BLK<br>(Window position<br>signal ground)                       |

## 106. Security LED Connector

- WHT
- Behind left kick panel
- Connects dashboard wire harness A to security control unit (Honda accessory)



- 1 BLU/BLK (Trunk lid position circuit)
- 2 \*Male - BLK/YEL  
Female - BLK/YEL  
(Security system)
- 3 BLU (Taillight relay)
- 4 -

\* = Connector inserted by Honda Accessory

## 109. C205

- YEL
- Under right side of dash
- Connects right engine compartment wire harness to SRS main wire harness

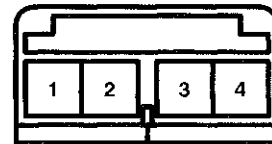

- 1 -
- 2 LT BLU or BLU (SRS)
- 3 GRN or BLU (SRS)
- 4 -

## 107. Trunk Lid Opener Relay (Honda Accessory)

- BRN/NAT
- Under driver's seat
- On security system harness (Honda Accessory)

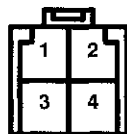

- 1 WHT (Fuse 26)
- 2 WHT (Fuse 26)
- 3 BLK/YEL (Trunk lid opener control (+))
- 4 BLK/ORN (Relay control (-) input)

## 110. C305

- YEL
- Under left side of dash
- Connects left engine compartment wire harness to SRS main wire harness

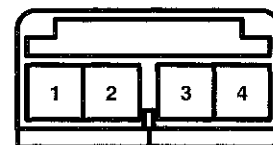

- 1 -
- 2 BRN (SRS)
- 3 RED or BRN (SRS)
- 4 -



### 111. Blower Power Transistor

- NAT
- Under right side of dash
- On dashboard wire harness B (right branch)

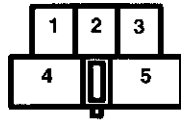

- 1 BLU/RED (Blower feedback output)
- 2 —
- 3 BLU/YEL (Power transistor base input)
- 4 BLU/BLK (Blower motor control)
- 5 BLK (G402)

### 114. Steering Angle Sensor

- GRN
- In steering column cover
- On dashboard wire harness B (left branch)

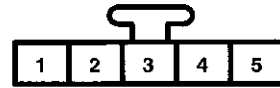

- 1 BLK (G401)
- 2 WHT (CAN1 L)
- 3 —
- 4 RED (CAN1 H)
- 5 BLK/YEL (Fuse 6)

### 112. Engine Start Switch

- GRN
- Left of steering wheel
- On dashboard wire harness A

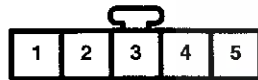

- 1 BLU/WHT (Switch output (+))
- 2 BLK/WHT (Fuse 3)
- 3 BLK (G501)
- 4 —
- 5 —

### 115. Windshield Wiper Motor

- GRY
- Under left side of windshield
- On left engine compartment wire harness

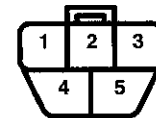

- 1 BLU/YEL (Motor high control input (-))
- 2 BLU (Motor low control input (-))
- 3 BLK (G301)
- 4 GRN/BLK (Fuse 8)
- 5 BLU/WHT (PARK (+) or RUN (-) output)

### 113. Fuel Tank Unit

- GRY
- Middle of fuel tank
- On rear wire harness (left branch)



- 1 BLK (Fuel gauge return)
- 2 YEL/BLK (Fuel gauge output)
- 3 —
- 4 BLK (G601)
- 5 YEL/GRN (Fuel pump control (+))

### 116. APP Sensor

- BLK
- Left side of engine compartment
- On left engine compartment wire harness



- 1 YEL/BLU (Electronic throttle control system)
- 2 GRN (Electronic throttle control system)
- 3 RED/YEL (Electronic throttle control system)
- 4 RED/BLU (Electronic throttle control system)
- 5 YEL/RED (Electronic throttle control system)
- 6 GRN/WHT (Electronic throttle control system)

# Connector Terminal Views

## 117. Audio Remote Switch (USA: Base, CR Audio – A/C; Canada)

- GRN
- Left of steering wheel
- On dashboard wire harness A



- 1 YEL/BLU (Remote MUTE output)
- 2 WHT/RED (Fuse 9)
- 3 RED/BLK (Dash and console lights (+))
- 4 RED (Dash and console lights (-))
- 5 BLK (G501)
- 6 GRN/RED (Audio remote switches output)

## 118. Convertible Top Switch (USA: Base; Canada)

- GRY
- Below center of console
- On dashboard wire harness B (right branch)

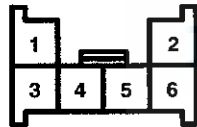

- 1 RED/BLK (Top OPEN output (+))
- 2 RED/YEL (Top CLOSE output (+))
- 3 BLK/WHT (Fuse 12)
- 4 —
- 5 RED/BLK (Dash and console lights (+))
- 6 RED (Dash and console lights (-))

## 119. Cruise Control Main Switch

- NAT
- Left of steering wheel
- On dashboard wire harness A

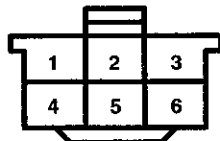

- 1 LT GRN (Switch output (+))
- 2 RED/BLK (Dash and console lights (+))
- 3 RED (Dash and console lights (-))
- 4 —
- 5 BLK (G501)
- 6 BLK/YEL (Fuse 6)

## 120. Intermittent Wiper Relay

- BRN/NAT
- Left side of engine compartment
- On left engine compartment wire harness

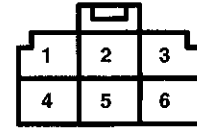

- |   |                                       |
|---|---------------------------------------|
| 1 BLK (G301)  | 4 BLU/WHT (RUN to Park input (-))     |
| 2 GRN/RED (Intermittent control output or RUN to Park output (-)) | 5 —                                   |
| 3 GRN/BLK (Fuse 8)  | 6 GRN (Wiper relay control input (-)) |

## 121. Rear Window Defogger Change Relay (USA: Base; Canada)

- GRY
- Left side of trunk
- On rear wire harness (left branch)

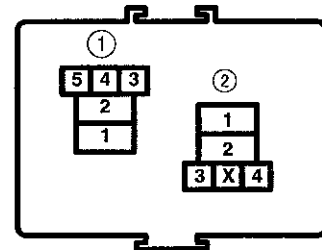

### ① Rear Window Defogger Change Relay:

- 1 BLK/RED (Power)
- 2 BRN (Hardtop defogger output)
- 3 LT GRN/WHT (Hardtop installed input)
- 4 BLK (Softtop defogger output)
- 5 BLK/YEL (Fuse 6)

### ② Not used



## 122. Rear Window Defogger Switch

- BLU
- Below center of console
- On dashboard wire harness B (right branch)

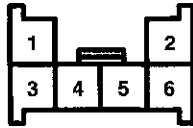

- 1 BLK/RED (Defogger ON indicator)
- 2 —
- 3 RED (Illumination (negative) circuit)
- 4 BLK (G402)
- 5 RED/BLK (Illumination (positive) circuit)
- 6 BLK/YEL (Defogger request signal)

## 125. VSA Off Switch

- NAT
- Right of steering wheel
- On dashboard wire harness A

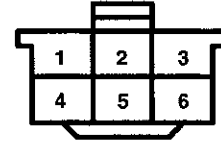

- 1 WHT (VSA system)
- 2 RED/BLK (Illumination (positive) circuit)
- 3 RED (Illumination (negative) circuit)
- 4 —
- 5 —
- 6 BLK (G501)

## 123. TP Sensor/Throttle Actuator

- BLK
- Left side of engine
- On engine wire harness



- 1 RED/BLK (Electronic throttle control system)
- 2 BLU (Electronic throttle control system)
- 3 RED (Electronic throttle control system)
- 4 GRN (Electronic throttle control system)
- 5 WHT/BLU (Electronic throttle control system)
- 6 WHT/BLK (Electronic throttle control system)

## 126. VSA Sensor Cluster

- BLK/GRY
- Behind rear of console
- On rear wire harness (left branch)

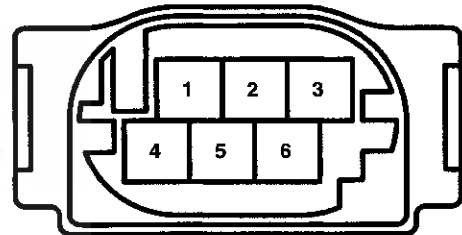

- 1 GRN/WHT (PWR)
- 2 WHT (CAN2 H)
- 3 RED (CAN2 L)
- 4 —
- 5 LT GRN (GND)
- 6 —

## 124. Unlock Relay, Driver's Only (Honda Accessory)

- BRN/NAT
- Under driver's seat
- On security system harness (Honda Accessory)

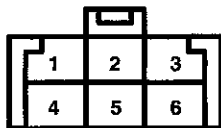

- 1 WHT (Fuse 26)
- 2 YEL/GRN (Driver's door unlock control (+))
- 3 WHT (Fuse 26)
- 4 YEL/WHT (Unlock signal (+))
- 5 —
- 6 YEL/RED (Relay control input (-))

## 127. Power Window Switch, Passenger's

- GRN
- Passenger's door
- On passenger's door wire harness



- 1 BLU/WHT (DOWN signal output (+))
- 2 BLK (G501)
- 3 RED/WHT (Window main switch, power input)
- 4 BLU/RED (UP signal output (+))
- 5 —
- 6 RED/BLU (UP (+) or DOWN (-) signal confirmation output)

# Connector Terminal Views

## 128. C102

- WHT
- Behind left kick panel
- Connects engine wire harness to dashboard wire harness A

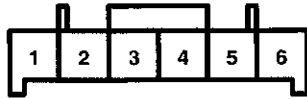

- |  |   |
|--|---|
| 1 Male - GRN/YEL<br>Female - GRN/WHT<br>(Electronic throttle control system) | 4 RED/YEL (Electronic throttle control system)  |
| 2 Male - YEL/BLU<br>Female - YEL/RED<br>(Electronic throttle control system) | 5 Male - WHT<br>Female - RED<br>(PGM-FI system) |
| 3 RED/BLU (Electronic throttle control system)                               | 6 BLK/WHT (PGM-FI system)                       |

## 129. C402

- LT BLU
- Under left side of dash
- Connects dashboard wire harness B (left branch) to dashboard wire harness A

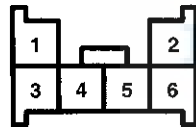

- |  |
|--|
| 1 ORN (Horn relay control circuit)                     |
| 2 BLK/WHT (Fuse 3)                                     |
| 3 GRN/WHT (Recirculation control - fresh (FRS) signal) |
| 4 GRN/YEL (Recirculation control - REC signal)         |
| 5 BLK/YEL (Rear defogger)                              |
| 6 YEL/BLU (Rear defogger)                              |

## 130. C503

- YEL
- Under left side of dash
- Connects dashboard wire harness A to SRS main wire harness

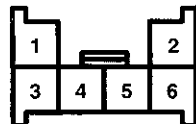

- |  |  |
|--|--|
| 1 Male - PNK<br>Female - PNK or BLU<br>(SRS)                           | 5 Male - BRN<br>Female - BRN or BLU<br>(Service check signal circuit)      |
| 2 BLK (G501)   | 6 Male - GRY<br>Female - GRY or BLU<br>(Offboard diagnosis signal circuit) |
| 3 BLU (SRS)  |  |
| 4 Male - BLK/YEL<br>Female - BLK/YEL or BLU<br>(Gauges and Indicators) |  |

## 131. Air Mix Control Motor

- GRN
- Under right side of dash
- On dashboard wire harness B (right branch)



- |                           |
|---------------------------|
| 1 PNK/BLU (M-HOT)         |
| 2 PNK (M-COOL)            |
| 3 PNK/BLK (AMD-P)         |
| 4 -                       |
| 5 GRY (S5V)               |
| 6 -                       |
| 7 LT GRN (Common (S-COM)) |

## 132. Ignition Key Switch/Key Light

- GRN
- In steering column cover
- On dashboard wire harness B (left branch)



- |                               |
|-------------------------------|
| 1 BLK (G401)                  |
| 2 -                           |
| 3 RED/WHT (Switch output (-)) |
| 4 -                           |
| 5 -                           |
| 6 -                           |
| 7 -                           |

## 133. Immobilizer Control Unit-Receiver

- WHT
- In steering column cover
- On dashboard wire harness B (left branch)



- |  |
|--|
| 1 GRN/WHT (Ground for ECM sensors (LG3) circuit) |
| 2 RED/BLU (Immobilizer code input (IMOCD))       |
| 3 LT BLU (DLC input/output circuit)              |
| 4 GRN/WHT (Parking brake position circuit)       |
| 5 PNK (Immobilizer system indicator)             |
| 6 BLK/YEL (Fuse 2)                               |
| 7 WHT/RED (Fuse 25)                              |



### 134. Mode Control Motor

- GRN
- Under left middle of dash
- On dashboard wire harness B (right branch)



- 1 YEL/RED (M-VENT)
- 2 YEL/BLU (M-DEF)
- 3 YEL (MODE 4)
- 4 BLK/WHT (MODE 3)
- 5 YEL/GRN (MODE 2)
- 6 BRN/WHT (MODE 1)
- 7 LT GRN (Common (S-COM))

### 135. Recirculation Control Motor

- GRN
- Under right side of dash
- On dashboard wire harness B (right branch)



- 1 BLK/YEL (IG2)
- 2 —
- 3 —
- 4 —
- 5 GRN/WHT (FRS)
- 6 —
- 7 GRN/YEL (REC)

### 136. C202

- WHT
- Under right side of dash
- Connects right engine compartment wire harness to dashboard wire harness B (right branch)

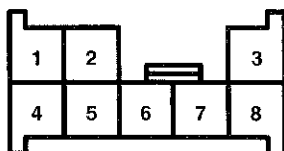

- |  |  |
|--|--|
| 1 RED/WHT (Fuse 43)                      | 6 USA: Base; Canada: GRY/RED (Fuse 52) |
| 2 RED/ORN (L high beam control)          | 7 USA: Base; Canada: GRY (Fuse 55)     |
| 3 USA: CR, CR Audio – A/C: BLU (Fuse 53) | 8 RED/BLU (R high beam control)        |
| 4 YEL (Fuse 59)                          |  |
| 5 RED/YEL (Fuse 45)                      |  |

### 137. C203

- BRN
- Under right side of dash
- Connects right engine compartment wire harness to dashboard wire harness B (right branch)

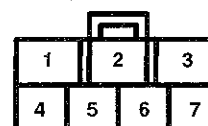

- 1 WHT/BLU (Fuse 50 – VSA)
- 2 BLU/WHT (Blower motor relay)
- 3 WHT (Fuse 42 – Ignition switch)
- 4 WHT/RED (Fuse 48 – VSA)
- 5 —
- 6 WHT/BLK (Fuse 51 to fuses 17 and 18)
- 7 YEL (Fuse 54 to fuses 22-27)

### 138. C304

- WHT
- Under left side of dash
- Connects dashboard wire harness A to left engine compartment wire harness

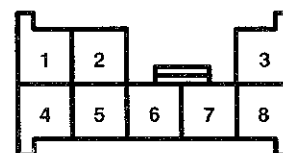

- 1 RED/YEL (PGM-FI system)
- 2 WHT (F-CAN communications line (low) circuit)
- 3 RED (F-CAN communications line (high) circuit)
- 4 YEL/BLU (Reference voltage for ECM sensors (VCC3) circuit)
- 5 RED/BLU (Electronic throttle control system)
- 6 RED/YEL (Electronic throttle control system)
- 7 YEL/RED (Electronic throttle control system)
- 8 GRN/WHT (Electronic throttle control system)

# Connector Terminal Views

## 139. C603

- GRY
- Behind rear of console
- Connects SRS main wire harness to rear wire harness (left branch)

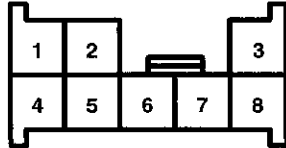

- |   |   |
|---|---|
| <p>1 Male - LT GRN<br/>Female - LT GRN or BLU<br/>(Driver's seat belt buckle switch (BSDH))</p> <p>2 Male - YEL<br/>Female - YEL or BLU<br/>(Driver's seat belt buckle switch (BSDL))</p> <p>3 -</p> <p>4 Male - ORN<br/>Female - ORN or BLU<br/>(Passenger's seat belt buckle switch (BSPH))</p> | <p>5 BLU (Passenger's seat belt buckle switch (BSPL))</p> <p>6 Male - LT GRN<br/>Female - LT GRN or BLU (SRS)</p> <p>7 Male - GRY<br/>Female - GRY or BLU (SRS)</p> <p>8 Male - GRN<br/>Female - GRN or BLU (SRS)</p> |
|---|---|

## 141. Power Mirror Switch

- GRN
- Driver's door
- On driver's door wire harness



- |   |   |
|---|---|
| <p>1 -</p> <p>2 -</p> <p>3 BLU/WHT (Right mirror left/right control)</p> <p>4 RED (Left mirror left/right control)</p> <p>5 GRN/WHT (Up/down control)</p> | <p>6 RED/BLU (Right mirror common)</p> <p>7 RED/YEL (Left mirror common)</p> <p>8 -</p> <p>9 YEL/BLK (Fuse 19)</p> <p>10 BLK (G501)</p> |
|---|---|

## 142. C405 (Junction Connector)

- BRN
- Under left side of dash
- On dashboard wire harness B (left branch)

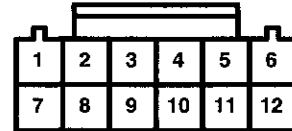

- |   |  |
|---|--|
| <p>1 -</p> <p>2 -</p> <p>3 RED (CAN1 H)</p> <p>4 RED (CAN1 H)</p> <p>5 RED (CAN1 H)</p> <p>6 RED (CAN1 H)</p> | <p>7 -</p> <p>8 -</p> <p>9 WHT (CAN1 L)</p> <p>10 WHT (CAN1 L)</p> <p>11 WHT (CAN1 L)</p> <p>12 WHT (CAN1 L)</p> |
|---|--|

## 140. Hazard Warning Switch

- GRY
- Below center of console
- On dashboard wire harness B (right branch)

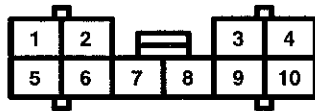

- |   |   |
|---|---|
| <p>1 GRN/RED (Left hazard control output)</p> <p>2 GRN/YEL (Right hazard control output)</p> <p>3 BLK/RED (Turn signal/hazard relay power)</p> <p>4 -</p> <p>5 RED/BLU (Fuse 7)</p> | <p>6 WHT/BLK (Fuse 49)</p> <p>7 -</p> <p>8 RED/BLK (Dash and console lights (+))</p> <p>9 RED (Dash and console lights (-))</p> <p>10 GRN/WHT (Hazard request output)</p> |
|---|---|





### 143. C453

- WHT
- Under right side of dash
- Connects dashboard wire harness A to dashboard wire harness B (right branch)

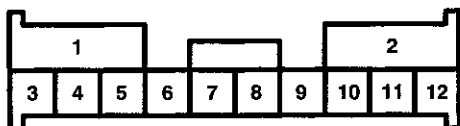

- 1 YEL/GRN (Electronic throttle control system)
- 2 WHT (Power source for ECM sensors circuit)
- 3 BRN (Electronic throttle control system)
- 4 GRN/WHT (DLC and MIL circuits)
- 5 BLK/YEL (Fuse 2)
- 6 PNK (Cruise control)
- 7 GRY (Cruise control)
- 8 ORN (PGM-FI system)
- 9 GRN/YEL (Ignition system)
- 10 GRN (PGM-FI main relay 1 control circuit)
- 11 RED (F-CAN communications line (high) circuit)
- 12 WHT (F-CAN communications line (low) circuit)

### 145. C507 (Junction Connector)

- BLU
- Under right side of dash
- On dashboard wire harness A

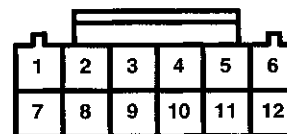

- 1 BLU (Gauges and Indicators)
- 2 BLU (Gauges and Indicators)
- 3 BLU (Gauges and Indicators)
- 4 BLU (Gauges and Indicators)
- 5 GRN (Fans)
- 6 GRN (Fans)
- 7 BRN (Service check signal circuit)
- 8 BRN (Service check signal circuit)
- 9 BRN (Service check signal circuit)
- 10 BRN (Service check signal circuit)
- 11 —
- 12 GRN (Fans)

Terminals grouped together are connected by the same bus bar.

### 144. C505

- WHT
- Behind left kick panel
- Connects dashboard wire harness A to rear wire harness (left branch)

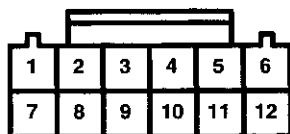

- 1 WHT/RED (Audio system)
- 2 WHT (Audio system)
- 3 BLK (Audio system)
- 4 RED (Audio system)
- 5 GRN (Audio system)
- 6 GRY (Audio system)
- 7 BLK/YEL (Fuse 2 - Under-dash)
- 8 BLK (Fuel gauge)
- 9 WHT (VSA system)
- 10 RED (VSA system)
- 11 LT GRN (VSA system)
- 12 GRN/WHT (VSA system)

### 146. C103

- WHT
- Behind left kick panel
- Connects engine wire harness to dashboard wire harness A

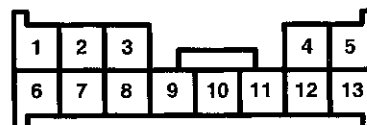

- 1 BLU (Electronic throttle control system)
- 2 Male - RED  
Female - RED/BLU (Electronic throttle control system)
- 3 BLU (Electronic throttle control system)
- 4 RED/BLK (Electronic throttle control system)
- 5 GRN (Electronic throttle control system)
- 6 Male - WHT/BLU  
Female - GRN (Electronic throttle control system)
- 7 BLK (Electronic throttle control system)
- 8 —
- 9 —
- 10 —
- 11 GRN (Electronic throttle control system)
- 12 —
- 13 Male - WHT/BLK  
Female - BLU (Electronic throttle control system)

# Connector Terminal Views

## 147. CD Changer (Honda Accessory)

- In trunk
- CD changer BUS cable

### Canada:

- LT BLU

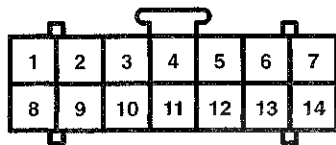

- |                      |                       |
|----------------------|-----------------------|
| 1 BLK (Audio system) | 8 BLK (Audio system)  |
| 2 RED (Audio system) | 9 WHT (Audio system)  |
| 3 —                  | 10 BLK (Audio system) |
| 4 BRN (Audio system) | 11 —                  |
| 5 BLU (Audio system) | 12 YEL (Audio system) |
| 6 —                  | 13 GRN (Audio system) |
| 7 —                  | 14 —                  |

### USA:

- WHT

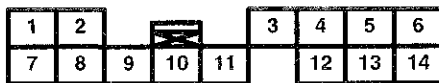

- |   |   |
|---|---|
| 1 Male - PNK<br>Female - LT BLU<br>(Audio system) | 8 Male - —<br>Female - YEL<br>(Not used)  |
| 2 BRN (Audio system)                              | 9 ORN (Audio system)                      |
| 3 BLK (Audio system)                              | 10 GRY (Audio system)                     |
| 4 BLK (Audio system)                              | 11 PUR (Audio system)                     |
| 5 RED (Audio system)                              | 12 Male - —<br>Female - BLU<br>(Not used) |
| 6 WHT (Audio system)                              | 13 GRN (Audio system)                     |
| 7 Male - —<br>Female - PNK<br>(Not used)          | 14 BLK (Audio system)                     |

## 148. DRL Control Unit

- WHT/GRY
- Under left side of dash
- On dashboard wire harness B (right branch)



- |  |  |
|--|--|
| 1 RED/WHT (Headlights)   | 8 BLU/RED<br>(High beam cut relay)                       |
| 2 USA: WHT<br>(DRL sub control unit)<br>Canada: RED/BLU<br>(Fuse 27) | 9 Canada: BLU/WHT<br>(DRL indicator control)             |
| 3 RED/YEL (Fuse 45)  | 10 Canada: RED/BLU<br>(High beam headlights<br>ON input) |
| 4 BLK (G402)   | 11 RED/ORN<br>(R high beam control)                      |
| 5 RED/WHT (Fuse 43)  | 12 YEL/BLK (Fuse 19)                                     |
| 6 GRN/WHT (Parking<br>brake position circuit)                        | 13 —   |
| 7 BLK (G402)   | 14 —   |

## 149. DRL Sub-control Unit (USA)

- GRY
- Under left side of dash
- On dashboard wire harness B (right branch)

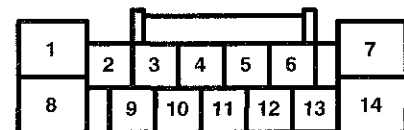

- |   |                                     |
|---|-------------------------------------|
| 1 YEL/BLK (Fuse 19)                           | 8 BLK (G401)                        |
| 2 —   | 9 BLK (G401)                        |
| 3 BLU/WHT (DRL<br>indicator)                  | 10 —                                |
| 4 RED/BLU (Headlights)                        | 11 —                                |
| 5 GRN/WHT (Parking<br>brake position circuit) | 12 BLU/RED<br>(High beam cut relay) |
| 6 —   | 13 —                                |
| 7 WHT (DRL control unit)                      | 14 RED/BLU (Fuse 27)                |



## 150. Power Window Master Switch

- GRY
- Driver's door
- On driver's door wire harness

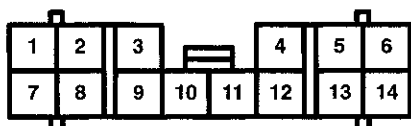

- |   |   |
|---|---|
| <ul style="list-style-type: none"> <li>1 BLK (G501)</li> <li>2 BLK (SGND)</li> <li>3 RED/YEL<br/>(Driver's window down (+) output)</li> <li>4 GRN/BLK (Fuse 8)</li> <li>5 RED/BLK (Driver's window up (+) output)</li> <li>6 BLU/WHT<br/>(Passenger's window down (+) output)</li> <li>7 —</li> </ul> | <ul style="list-style-type: none"> <li>8 BLU (PLS)</li> <li>9 —</li> <li>10 —</li> <li>11 GRN/WHT (Fuse 17)</li> <li>12 RED/WHT<br/>(Main switch (+) output)</li> <li>13 BLU/RED (Passenger's window up (+) output)</li> <li>14 BLU/ORN<br/>(Driver's window down control input)</li> </ul> |
|---|---|

## 152. C301

- GRY
- Under left side of dash
- Connects left engine compartment wire harness to dashboard wire harness B (left branch)



- |   |  |
|---|--|
| <ul style="list-style-type: none"> <li>1 WHT/GRN (Fuse 34)</li> <li>2 BLU/WHT (Intermittent wiper circuit)</li> <li>3 GRN/BLK (Fuse 8)</li> <li>4 BLU (Wiper/washer)</li> <li>5 RED/BLU (Headlights)</li> <li>6 GRN/RED<br/>(Wiper/washer)</li> <li>7 GRN (Wiper/washer)</li> <li>8 RED/YEL (Headlights)</li> </ul> | <ul style="list-style-type: none"> <li>9 BLK/YEL (Fuse 6)</li> <li>10 —</li> <li>11 RED/WHT<br/>(DRL)</li> <li>12 BLU/YEL<br/>(Wiper/washer)</li> <li>13 GRN/RED<br/>(Turn signal lights)</li> <li>14 RED/BLK<br/>(Exterior lights circuit)</li> </ul> |
|---|--|

## 151. Wiper/Washer Switch

- GRY
- In steering column cover
- On dashboard wire harness B (left branch)

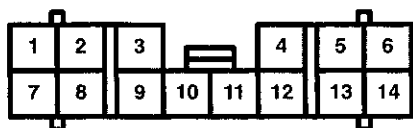

- |   |   |
|---|---|
| <ul style="list-style-type: none"> <li>1 —</li> <li>2 —</li> <li>3 —</li> <li>4 BLK (G401)</li> <li>5 BLU/YEL (HIGH motor control output (-))</li> <li>6 WHT/BLK<br/>(Washer request output)</li> <li>7 —</li> <li>8 —</li> </ul> | <ul style="list-style-type: none"> <li>9 —</li> <li>10 —</li> <li>11 BLU (LOW motor control output (-))</li> <li>12 GRN/RED<br/>(Intermittent control input or RUN to PARK input)</li> <li>13 BLU/BLK (Intermittent wiper request)</li> <li>14 BLK/WHT (Fuse 12)</li> </ul> |
|---|---|

## 153. Combination Light Switch

- GRY
- In steering column cover
- On dashboard wire harness B (left branch)

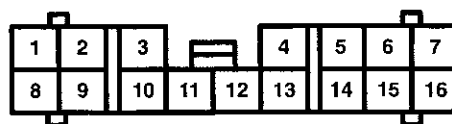

- |  |   |
|--|---|
| <ul style="list-style-type: none"> <li>1 —</li> <li>2 GRN/RED (Turn signal switch LEFT output)</li> <li>3 —</li> <li>4 ORN<br/>(High beam request output (-))</li> <li>5 —</li> <li>6 —</li> <li>7 BLU/RED (Headlight relays control output (-))</li> <li>8 —</li> </ul> | <ul style="list-style-type: none"> <li>9 —</li> <li>10 BLK/RED<br/>(Turn signal/hazard relay power)</li> <li>11 GRN/YEL (Turn signal switch RIGHT output)</li> <li>12 BLK (G401)</li> <li>13 BLU (Taillight relay)</li> <li>14 —</li> <li>15 —</li> <li>16 —</li> </ul> |
|--|---|

# Connector Terminal Views

## 154. DLC

- GRY
- Under left middle of dash
- On dashboard wire harness B (right branch)



- |   |  |
|---|--|
| 1 LT BLU (DLC input/output circuit)                               | 9 BRN (Service check signal circuit - Service check)         |
| 2 —   | 10 —   |
| 3 —   | 11 —   |
| 4 BLK (G401) (Ground for PGM Tester)                              | 12 GRN/WHT (Write enable)                                    |
| 5 GRN/WHT (Logic ground)  | 13 —   |
| 6 RED (F-CAN communications line (high) circuit)                  | 14 WHT (F-CAN communications line (low) circuit)             |
| 7 GRY (DLC and MIL circuits) (K line for off-board communication) | 15 —   |
| 8 —   | 16 WHT/GRN (Fuse 46) (Power for PGM Tester (B+, 4 amps max)) |

## 156. C101

- LT BLU
- Behind left kick panel
- Connects engine wire harness to dashboard wire harness A

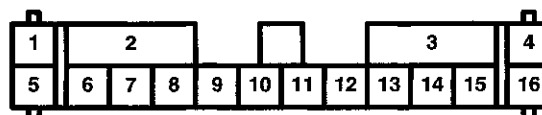

- |  |  |
|--|--|
| 1 Male - BLK/YEL<br>Female - GRN/YEL (Ignition system)                         | 8 BLU/WHT (Vehicle speed sensor signal 2 circuit)              |
| 2 USA: Base, CR Audio - A/C; Canada: Male - BLK/RED<br>Female - BLU/RED (HVAC) | 9 Male - YEL<br>Female - YEL/RED (Low oil pressure indicator)  |
| 3 BLK/WHT (Starting system)  | 10 —   |
| 4 YEL/BLK (Power source for ECM circuit)                                       | 11 YEL (Fuse 5)  |
| 5 BLK/YEL (Fuse 6)   | 12 Male - GRN/YEL<br>Female - GRN/BLK (Back-up lights circuit) |
| 6 Male - WHT/BLK<br>Female - WHT (Power source for ECM sensors circuit)        | 13 —   |
| 7 Male - WHT/BLU<br>Female - — (Not used)                                      | 14 Male - YEL/BLU<br>Female - RED/YEL (EVAP system)            |
|  | 15 RED/YEL (PGM-FI system)                                     |
|  | 16 —   |

## 155. Throttle Actuator Control Module

- GRY
- Under right side of dash
- On dashboard wire harness A

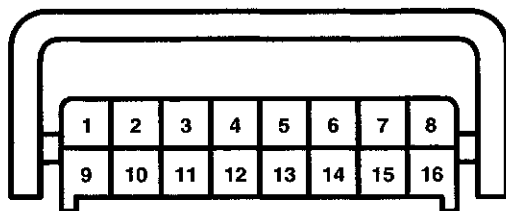

- |                  |                   |
|------------------|-------------------|
| 1 BLU (DBW M+)   | 9 GRN (SG)        |
| 2 YEL/GRN (DBW+) | 10 RED/BLK (THL1) |
| 3 —              | 11 BLU (VCC)      |
| 4 —              | 12 RED/BLU (THL2) |
| 5 —              | 13 —              |
| 6 GRN (SEFD)     | 14 BLU (SEDF)     |
| 7 BLK (G101)     | 15 —              |
| 8 GRN (DBW M-)   | 16 —              |

## 157. C201

- LT BLU
- Under right side of dash
- Connects right engine compartment wire harness to dashboard wire harness B (right branch)

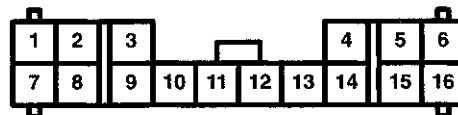

- |                          |                                     |
|--------------------------|-------------------------------------|
| 1 WHT/BLK (Wiper/washer) | 11 WHT/GRN (Fuse 46)                |
| 2 WHT/BLK (Fuse 49)      | 12 BLK/YEL (Charging system)        |
| 3 BLK (G402)             | 13 ORN (Horn relay control circuit) |
| 4 —                      | 14 BLU/RED (Headlights)             |
| 5 —                      | 15 GRN/YEL (Turn signal lights)     |
| 6 —                      | 16 RED/BLK (Exterior lights)        |
| 7 GRN/BLK (VSA)          |                                     |
| 8 BLU (VSA)              |                                     |
| 9 WHT/GRN (Fuse 47)      |                                     |
| 10 BLK/YEL (Fuse 20)     |                                     |



## 158. C302

- LT BLU
- Under left side of dash
- Connects left engine compartment wire harness to dashboard wire harness B (left branch)

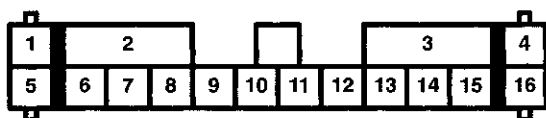

- |  |   |
|--|---|
| 1 —  | 11 RED (F-CAN communications line (high) circuit) |
| 2 WHT/BLU (Fuse 50)                              | 12 BLU/YEL (VSA)                                  |
| 3 WHT/RED (Fuse 48)                              | 13 GRN/WHT (VSA)                                  |
| 4 GRN/BLK (VSA)                                  | 14 GRY/RED (VSA)                                  |
| 5 —  | 15 YEL/RED (VSA)                                  |
| 6 —  | 16 BLU (VSA)                                      |
| 7 —  |   |
| 8 —  |   |
| 9 —  |   |
| 10 WHT (F-CAN communications line (low) circuit) |   |

## 160. C451

- LT BLU
- Under right side of dash
- Connects dashboard wire harness B (right branch) to dashboard wire harness A

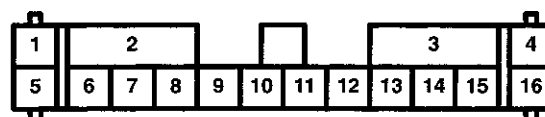

- |  |  |
|--|--|
| 1 BLU/BLK (Wiper/washer)                         | 10 LT GRN (HVAC)                                 |
| 2 WHT (Fuse 26)                                  | 11 USA: Base, CR Audio - A/C; Canada: BRN (HVAC) |
| 3 GRN/WHT (Fuse 17)                              | 12 BLU/RED (HVAC)                                |
| 4 BLU/ORN (Intermittent wiper circuit)           | 13 BLU/YEL (HVAC)                                |
| 5 GRN/YEL (Ceiling lights/spotlights or keyless) | 14 BLK/YEL (Fuse 20)                             |
| 6 PNK/BLK (HVAC)                                 | 15 WHT/BLK (Wiper/washer)                        |
| 7 PNK/BLU (HVAC)                                 | 16 BLK (G402)                                    |
| 8 PNK (HVAC)                                     |  |
| 9 GRY (HVAC)                                     |  |

## 159. C403

- LT BLU
- Under left side of dash
- Connects dashboard wire harness B (left branch) to dashboard wire harness A

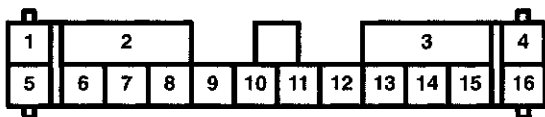

- |  |  |
|--|--|
| 1 BRN/WHT (HVAC)   | 11 USA: Base, CR Audio - A/C; Canada: WHT/RED (Fuse 9 - Accessory power) |
| 2 GRN/BLK (Fuse 8)   | 12 YEL/BLK (Power source for ECM circuit)                                |
| 3 BLK/WHT (Starting system)  | 13 WHT/BLK (Brake pedal position circuit)                                |
| 4 —  | 14 YEL (Fuse 5)  |
| 5 YEL/RED (HVAC)   | 15 USA: Base, CR Audio - A/C; Canada: WHT/BLU (Fuse 22 - Audio system)   |
| 6 YEL/GRN (HVAC)   | 16 WHT/RED (Fuse 25)   |
| 7 BLK/WHT (HVAC)   |  |
| 8 YEL (HVAC)   |  |
| 9 YEL/BLU (HVAC)   |  |
| 10 Male - WHT/BLK Female - — (Vehicle speed sensor signal 1 circuit) |  |

## 161. C504

- GRY
- Under right side of dash
- Connects dashboard wire harness A to passenger's door wire harness

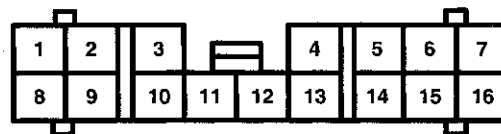

- |   |   |
|---|---|
| 1 BLK (G501)  | 9 RED (Power windows)                                       |
| 2 RED/BLU (Power windows)                                   | 10 RED/WHT (Power windows)                                  |
| 3 RED/BLU (Power mirrors)                                   | 11 BLU/RED (Power windows)                                  |
| 4 BLU/WHT (Power windows)                                   | 12 GRN/WHT (Power mirrors)                                  |
| 5 USA: Base, CR Audio - A/C; Canada: GRN/BLK (Audio system) | 13 BLU/WHT (Power mirrors)                                  |
| 6 PNK/BLK (Power door locks)                                | 14 USA: Base, CR Audio - A/C; Canada: LT GRN (Audio system) |
| 7 —   | 15 PNK/BLU (Power door locks)                               |
| 8 RED/BLU (Power windows)                                   | 16 —  |

# Connector Terminal Views

## 162. Keyless Door Lock Control Unit

- GRY/WHT
- Under left side of dash



### Factory:

- On dashboard wire harness A

- |  |   |
|--|---|
| 1 —  | 9 YEL (Unlock input (-))                      |
| 2 GRN/YEL<br>(Ceiling light control)           | 10 YEL/BLK (Lock input (-))                   |
| 3 ORN (Horn relay control<br>circuit)          | 11 —  |
| 4 RED/BLK (Illumination<br>(positive) circuit) | 12 —  |
| 5 BLK/YEL<br>(Trunk lid opener signal)         | 13 RED/WHT (Ignition<br>key switch input)     |
| 6 PNK/BLK<br>(Lock signal (+))                 | 14 BLK/WHT<br>(Door open input)               |
| 7 YEL/GRN (Driver's<br>unlock signal (+))      | 15 WHT (Switch input)                         |
| 8 WHT (Fuse 26)                                | 16 YEL (Fuse 5)                               |
|  | 17 BLK (G501)                                 |
|  | 18 PNK/BLU (Passenger's<br>unlock signal (+)) |

### Honda Accessory:

- On security system harness (Honda Accessory)

- |  |   |
|--|---|
| 1 —  | 9 YEL (Unlock input (-))                      |
| 2 GRN/YEL<br>(Ceiling light control)           | 10 YEL/BLK (Lock input (-))                   |
| 3 ORN (Horn relay control<br>circuit)          | 11 GRN/RED (Unlock)                           |
| 4 RED/BLK (Illumination<br>(positive) circuit) | 12 BLK/WHT (Lock)                             |
| 5 BLK/YEL<br>(Trunk lid opener signal)         | 13 RED/WHT (Ignition<br>key switch input)     |
| 6 PNK/BLK<br>(Lock signal (+))                 | 14 BLK/WHT<br>(Door open input)               |
| 7 YEL/WHT<br>(Driver's unlock<br>signal (+))   | 15 WHT (Switch input)                         |
| 8 WHT (Fuse 26)                                | 16 YEL (Fuse 5)                               |
|  | 17 BLK (G501)                                 |
|  | 18 PNK/BLU (Passenger's<br>unlock signal (+)) |

## 163. C104 (Junction Connector)

- PNK
- Behind left kick panel
- On engine wire harness



- |   |                                 |
|---|---------------------------------|
| 1 YEL/BLK (Power source<br>for ECM circuit) | 11 BLK/YEL<br>(Ignition system) |
| 2 YEL/BLK (Power source<br>for ECM circuit) | 12 BLK/YEL<br>(Ignition system) |
| 3 YEL/BLK (Power source<br>for ECM circuit) | 13 BLK/YEL<br>(Ignition system) |
| 4 YEL/BLK (Power source<br>for ECM circuit) | 14 BLK/YEL<br>(Ignition system) |
| 5 YEL/BLK (Power source<br>for ECM circuit) | 15 BLK/YEL<br>(Ignition system) |
| 6 YEL/BLK (Power source<br>for ECM circuit) | 16 BRN/YEL (G101)               |
| 7 YEL/BLK (Power source<br>for ECM circuit) | 17 BRN/YEL (G101)               |
| 8 YEL/BLK (Power source<br>for ECM circuit) | 18 BRN/YEL (G101)               |
| 9 YEL/BLK (Power source<br>for ECM circuit) | 19 BRN/YEL (G101)               |
| 10 —  | 20 BRN/YEL (G101)               |

Terminals grouped together are connected by the same bus bar.

## 164. C204

- WHT
- Under right side of dash
- Connects dashboard wire harness A to right engine compartment wire harness

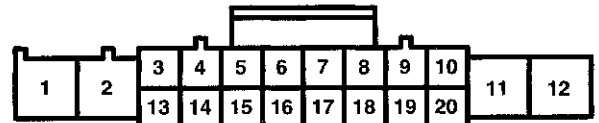

- |   |   |
|---|---|
| 1 RED/YEL (Fuse 45)   | 11 BLK (G501)   |
| 2 USA: Base, CR Audio -<br>A/C; Canada: BLU/RED<br>(Compressor clutch<br>control (+)) | 12 —  |
| 3 YEL/BLU (EPS)   | 13 RED (Compressor clutch<br>control (-))                                 |
| 4 WHT/BLK (Vehicle<br>speed sensor signal 1<br>circuit)                               | 14 GRN/RED (ELD Unit)   |
| 5 BLU/BLK (EPS)   | 15 USA: Base, CR Audio -<br>A/C; Canada: BLU/RED<br>(A/C pressure switch) |
| 6 YEL (Fuse 5)  | 16 —  |
| 7 BLU (EPS)   | 17 USA: Base, CR Audio -<br>A/C; Canada: BLU/WHT<br>(A/C pressure switch) |
| 8 BRN (Service check<br>signal circuit)   | 18 GRN (Fans)   |
| 9 LT BLU (DLC<br>input/output circuit)  | 19 —  |
| 10 BLK (Outside air<br>temperature sensor)  | 20 PNK (Outside air<br>temperature sensor)                                |



### 165. C303

- WHT
- Under left side of dash
- Connects dashboard wire harness A to left engine compartment wire harness

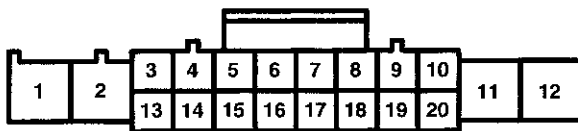

- |  |  |
|--|--|
| 1 BLK (G501)                                 | 10 —   |
| 2 —  | 11 BLU (ECT2)                                    |
| 3 Male - GRN/BLK<br>Female - —<br>(Not used) | 12 RED/WHT<br>(High beam indicator)              |
| 4 Male - GRN<br>Female - —<br>(Not used)     | 13 GRY (VSA system)                              |
| 5 PNK (VSA system)                           | 14 GRN (Ground for ECM<br>sensors (SG3) circuit) |
| 6 LT GRN (VSA system)                        | 15 PNK/BLK (VSA system)                          |
| 7 GRN/WHT<br>(VSA system)                    | 16 GRN (VSA system)                              |
| 8 RED/YEL<br>(EVAP system)                   | 17 WHT (VSA OFF SW)                              |
| 9 —  | 18 BLU/RED (VSA system)                          |
|  | 19 BLU (Engine speed<br>signal circuit)          |
|  | 20 GRN/RED (Brake fluid<br>level circuit)        |

### 167. TPMS Control Unit

- GRY
- Under left side of dash
- On dashboard wire harness B (left branch)

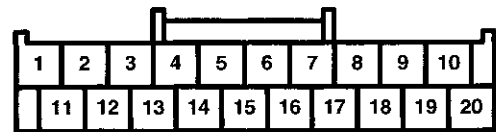

- |                |                |
|----------------|----------------|
| 1 WHT (CAN-H)  | 11 RED (CAN-L) |
| 2 —            | 12 —           |
| 3 —            | 13 —           |
| 4 BLK (GND)    | 14 —           |
| 5 —            | 15 —           |
| 6 —            | 16 —           |
| 7 GRY (K-LINE) | 17 —           |
| 8 YEL (IG1)    | 18 —           |
| 9 —            | 19 —           |
| 10 RED (+)     | 20 —           |

### 166. C502

- GRY
- Behind left kick panel
- Connects dashboard wire harness A to driver's door wire harness

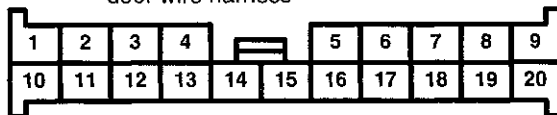

- |   |  |
|---|--|
| 1 YEL/GRN (Power door<br>locks/keyless entry)                         | 11 YEL (Power door<br>locks/keyless entry)                         |
| 2 YEL/BLK (Fuse 19 -<br>power mirror)                                 | 12 YEL/BLK (Power door<br>locks/keyless entry)                     |
| 3 WHT (Power door<br>locks/keyless entry)                             | 13 RED/BLU<br>(Right mirror common)                                |
| 4 BLU/WHT<br>(Power mirrors)  | 14 BLK (G501)  |
| 5 GRN/WHT<br>(Power windows)  | 15 BLU/WHT (Convertible<br>top or power windows)                   |
| 6 GRN/WHT (Fuse 17 -<br>power windows)                                | 16 BLU/RED (Convertible<br>top or power windows)                   |
| 7 USA: Base; Canada:<br>BLU/ORN (Convertible<br>top or power windows) | 17 GRN/BLK (Fuse 8 -<br>power windows)                             |
| 8 USA: Base, CR Audio -<br>A/C; Canada: GRN/YEL<br>(Audio system)     | 18 RED/WHT<br>(Power windows)                                      |
| 9 —   | 19 USA: Base, CR Audio -<br>A/C; Canada: GRY/RED<br>(Audio system) |
| 10 PNK/BLK (Power door<br>locks/keyless entry)                        | 20 —   |

### 168. Security Control Unit (Honda Accessory)

- GRN
- Under driver's seat
- On security system harness (Honda Accessory)

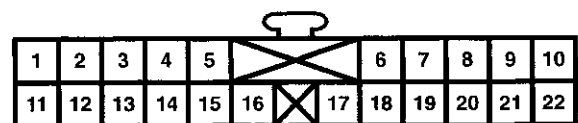

- |  |  |
|--|--|
| 1 —  | 11 YEL/BLU (Ignition ON<br>input - In-line fuse 2) |
| 2 BLK/WHT<br>(Door open input)                 | 12 —   |
| 3 BLU/BLK<br>(Trunk lid latch switch<br>input) | 13 BLK (G501)                                      |
| 4 YEL/RED<br>(Hood switch input)               | 14 BLK/YEL (LED control)                           |
| 5 BLU<br>(Disarm switch input)                 | 15 RED/WHT (Ignition<br>key switch input)          |
| 6 BLK/WHT (Lock output)                        | 16 GRN/YEL<br>(Ceiling light control)              |
| 7 YEL/RED<br>(Unlock relay control)            | 17 BLU<br>(Taillight relay control)                |
| 8 GRN/RED<br>(Unlock output)                   | 18 ORN (Horn relay control<br>circuit)             |
| 9 —  | 19 —   |
| 10 WHT/BLU (Battery input<br>- In-line fuse 1) | 20 BLK/ORN<br>(Trunk lid open control)             |
|  | 21 —   |
|  | 22 —   |

## Connector Terminal Views

### 169. C401

- GRY
- Behind left kick panel
- Connects dashboard wire harness B (left branch) to rear wire harness (left branch)

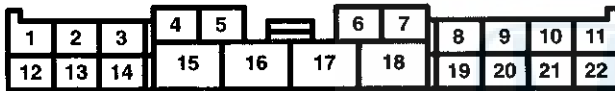

- |  |   |
|--|---|
| 1 USA: Base; Canada:<br>BLK/YEL (Fuse 6)     | 15 USA: Base; Canada:<br>LT GRN/RED<br>(Convertible top)                        |
| 2 BLU/YEL (VSA)                              | 16 USA: Base; Canada:<br>RED/WHT<br>(Convertible top)                           |
| 3 GRN/WHT (VSA)                              | 17 USA: Base; Canada:<br>RED (Convertible top)                                  |
| 4 GRY/RED (VSA)                              | 18 USA: Base; Canada:<br>RED/BLU<br>(Convertible top)                           |
| 5 YEL/RED (VSA)                              | 19 GRN/YEL<br>(Turn signal lights)  |
| 6 Male - BLK/YEL<br>Female - —<br>(Not used) | 20 WHT/BLK (Brake pedal<br>position circuit)                                    |
| 7 —  | 21 RED/BLK (Illumination<br>positive) circuit)                                  |
| 8 WHT (TPMS)                                 | 22 USA: Base; Canada:<br>WHT/RED<br>USA: CR, CR Audio -<br>A/C: WHT<br>(Fuse 9) |
| 9 RED (TPMS)                                 |   |
| 10 WHT (Fuse 26)                             |   |
| 11 YEL/GRN<br>(Fuel supply system)           |   |
| 12 BLK/RED<br>(Rear defogger)                |   |
| 13 WHT/BLU (Fuse 24)                         |   |
| 14 GRN/RED<br>(Turn signal lights)           |   |

### 170. C404

- LT BLU
- Under left side of dash
- Connects dashboard wire harness B (left branch) to dashboard wire harness A

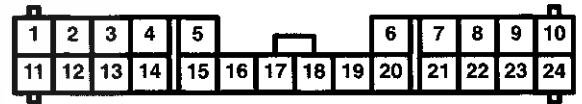

- |   |  |
|---|--|
| 1 BLU<br>(Lights-on reminder)                           | 13 Canada: RED/BLU<br>USA: YEL<br>(Headlights)     |
| 2 RED/BLK (Illumination<br>positive) circuit)           | 14 GRN/YEL<br>(Turn signal lights)                 |
| 3 GRY<br>(DLC and MIL circuits)                         | 15 GRN/RED<br>(Turn signal lights)                 |
| 4 LT GRN/RED<br>(Cruise control)                        | 16 GRN (Wiper/washer)                              |
| 5 LT GRN (Cruise control)                               | 17 GRN/WHT (Parking<br>brake position circuit)     |
| 6 BLU/WHT (DRL)   | 18 YEL/BLK (Fuse 19 -<br>Power mirror)             |
| 7 GRN/YEL<br>(Fuel supply system)                       | 19 RED/WHT<br>(Key-in reminder)                    |
| 8 RED/BLU<br>(Immobilizer system)                       | 20 BRN (Service check<br>signal circuit)           |
| 9 LT GRN/BLK (Resume<br>switch input (RES))             | 21 BLK/YEL (Fuse 6)                                |
| 10 LT BLU (DLC<br>input/output circuit)                 | 22 Male - GRN/RED<br>Female - —<br>(Not used)      |
| 11 GRN/WHT (Ground for<br>ECM sensors (LG3)<br>circuit) | 23 BLU/WHT (Engine start<br>switch signal circuit) |
| 12 RED (Illumination<br>negative) circuit)              | 24 PNK<br>(Immobilizer indicator)                  |





## 171. C501

- WHT
- Behind left kick panel
- Connects dashboard wire harness A to rear wire harness (left branch)

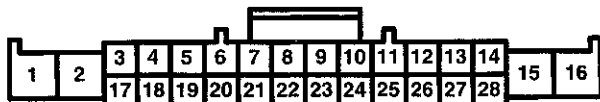

- |   |   |
|---|---|
| 1 BLU/YEL (Audio system)                                      | 16 WHT (Power source for ECM sensors circuit)                             |
| 2 RED/YEL (Audio system)                                      | 17 BRN/WHT (Audio system)   |
| 3 GRY/RED (Audio system)                                      | 18 BLU/BLK (Trunk lid position circuit)                                   |
| 4 YEL/BLK (Fuel gauge)  | 19 LT GRN/RED (DOOR SW (AS))  |
| 5 GRN/BLK (Back-up lights)                                    | 20 GRN (DOOR SW (DR))   |
| 6 GRN (Ground for ECM sensors (SG3) circuit)                  | 21 Male - YEL Female - BLU/RED (Driver's seat belt buckle switch circuit) |
| 7 -   | 22 LT GRN (EVAP system)   |
| 8 -   | 23 -  |
| 9 -   | 24 -  |
| 10 WHT (TPMS)   | 25 LT GRN/WHT (EVAP system)   |
| 11 RED (TPMS)   | 26 LT GRN (Convertible top system)  |
| 12 BLK/YEL (Power door locks/keyless entry)                   | 27 BLK (Audio system)   |
| 13 YEL/BLU (Reference voltage for ECM sensors (VCC3) circuit) | 28 WHT (Audio system)   |
| 14 WHT/RED (Fuse 25)  |   |
| 15 ORN (Audio system)   |   |

## 172. Heater Control Panel

- GRN
- Right of steering wheel
- On dashboard wire harness A



- |  |
|--|
| 1 PNK (Air mix control - M COOL output)  |
| 2 PNK/BLU (Air mix control - M HOT output)                                     |
| 3 YEL/BLU (Mode control - M DEF output)  |
| 4 YEL/RED (Mode control - M VENT output)                                       |
| 5 GRY (Voltage supply (+5V))   |
| 6 PNK/BLK (Air mix control - Door position input)                              |
| 7 USA: Base, CR Audio - A/C; Canada: BRN (Evaporator temperature sensor input) |
| 8 YEL/GRN (Mode control - MODE 2 output)                                       |
| 9 BRN/WHT (Mode control - MODE 1 output)                                       |
| 10 LT GRN (Sensor ground)  |
| 11 BLU/RED (HVAC)  |
| 12 USA: Base, CR Audio - A/C; Canada: BLU/WHT (A/C ON request output)          |
| 13 BLU/YEL (HVAC)  |
| 14 -   |
| 15 GRN/WHT (Recirculation control - Fresh (FRS) output)                        |
| 16 GRN/YEL (Recirculation control - (REC) output)                              |
| 17 -   |
| 18 -   |
| 19 -   |
| 20 -   |
| 21 YEL (Mode control - MODE 4 output)  |
| 22 BLK/WHT (Mode control - MODE 3 output)                                      |
| 23 BLK/WHT (Illumination cancel signal)  |
| 24 -   |
| 25 -   |
| 26 BLK (G402)  |
| 27 RED/BLK (Illumination (positive) circuit)                                   |
| 28 RED (Illumination (negative) circuit)                                       |
| 29 WHT/RED (Fuse 25)   |
| 30 BLK/YEL (Fuse 20)   |

# Connector Terminal Views

## 173. VSA Modulator-Control Unit

- BLK
- Left side of engine compartment
- On left engine compartment wire harness

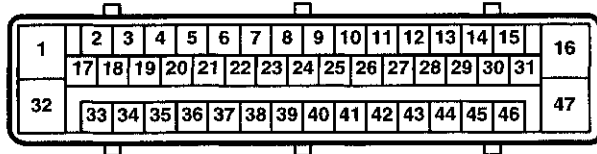

1 WHT/BLU (Fuse 50)	25 RED (CAN2 L)
2 GRY (K-LINE)	26 —
3 —	27 WHT (VSA OFF)
4 BLK/YEL (Fuse 6)	28 —
5 —	29 WHT (CAN2 H)
6 GRN/WHT (CLST-IG)	30 —
7 —	31 LT GRN (CLST-GND)
8 —	32 WHT/RED (Fuse 48)
9 GRN/RED (BFLS)	33 BLU (FR-GND)
10 —	34 GRN/BLK (FR +B)
11 RED (CAN1 H)	35 GRN (ACT)
12 —	36 YEL/RED (RL +B)
13 PNK (WL-EBD)	37 GRY/RED (RL-GND)
14 —	38 —
15 WHT (CAN1 L)	39 —
16 BLK (G303)	40 —
17 PNK/BLK (ACT)	41 —
18 —	42 BLU/YEL (RR-GND)
19 —	43 GRN/WHT (RR +B)
20 —	44 BLU/RED (ABS)
21 —	45 BLU/ORN (FL +B)
22 —	46 BRN/WHT (FL-GND)
23 —	47 BLK (G303)
24 —	

## 174. ACC Cut Relay and IG2 Relay

- GRY
- Under left side of dash
- On dashboard wire harness B (right branch)

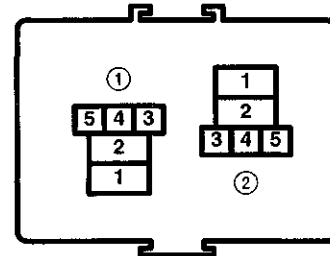

### ① ACC Cut Relay:

- 1 WHT/RED (Accessory power socket)
- 2 —
- 3 LT BLU (Clutch interlock switch)
- 4 YEL/RED (Fuse 9)
- 5 BLU/WHT (Engine start switch signal circuit)

### ② IG2 Relay:

- 1 BLK/RED (Ignition switch)
- 2 —
- 3 LT BLU (Clutch interlock switch)
- 4 YEL (Fuses 19 and 20)
- 5 BLU/WHT (Engine start switch signal circuit)



## 175. Audio Unit

– Behind audio unit

### Connector A

(USA: Base, CR Audio – A/C; Canada)

– LT BLU

– On dashboard wire harness A

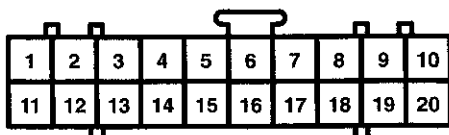

1 YEL/GRN (Antenna amplifier)	11 —
2 WHT/RED (Switched ignition input)	12 —
3 GRN/RED (Audio remote switch input)	13 —
4 —	14 YEL/BLU (Audio remote mute input)
5 RED/YEL (RR+)	15 BRN/WHT (RR-)
6 BLU/YEL (LR+)	16 GRY/RED (LR-)
7 GRN/BLK (RF+)	17 LT GRN (RF-)
8 GRN/YEL (LF+)	18 GRY/RED (LF-)
9 RED/BLK (ILL+)	19 RED (ILL-)
10 WHT/BLU (Battery input)	20 BLK (Ground)

### Connector B

(Honda Accessory) (Canada)

– LT BLU

– CD changer accessory BUS cable

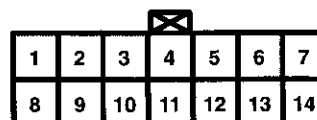

1 BLK (Audio system)	8 BLK (Audio system)
2 RED (Audio system)	9 WHT (Audio system)
3 —	10 BLK (Audio system)
4 BRN (Audio system)	11 —
5 BLU (Audio system)	12 YEL (Audio system)
6 —	13 GRN (Audio system)
7 —	14 —

### Connector B (USA)

– WHT

– On dashboard wire harness A



1 WHT/RED (+B)	8 —
2 WHT/RED (System Acc)	9 BLK (ECU BUS +)
3 ORN (BUS SH GND)	10 WHT (ECU BUS -)
4 GRY (Shield)	11 BLK (GND)
5 WHT (R+)	12 —
6 RED (L+)	13 BLK (R-)
7 WHT/RED (+B)	14 GRN (L-)

# Connector Terminal Views

## 176. Auxiliary Under-hood Fuse Box

- Left side of engine compartment
- On left engine compartment wire harness

### Connector A

- BLK/BRN

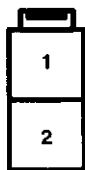

- 1 WHT/RED (Fuse 33)
- 2 —

### Connector B

- BRN/NAT

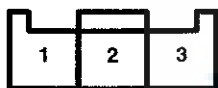

- 1 —
- 2 —
- 3 WHT/GRN (Fuse 34)

## 177. Cable Reel

- In steering column cover

### Connector A

- YEL
- On main SRS wire harness

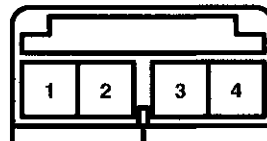

- |   |   |
|---|---|
| 1 Male - YEL<br>Female - GRN or BLU<br>(Driver's second inflator) | 3 Male - GRN<br>Female - LT BLU or BLU<br>(Driver's first inflator) |
| 2 Male - BLK<br>Female - PUR or BLU<br>(Driver's second inflator) | 4 Male - WHT<br>Female - BRN or BLU<br>(Driver's first inflator)    |

### Connector B:

- GRY
- On dashboard wire harness B (left branch)

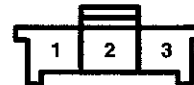

- |   |  |
|---|--|
| 1 Male - LT GRN/BLK<br>Female - BLU<br>(Cruise resume sw) | 3 Male - ORN<br>Female - BRN<br>(Horn relay control circuit) |
| 2 Male - LT GRN/RED<br>Female - RED<br>(Cruise set sw)    |  |



## 178. Convertible Top Control Unit (USA: Base; Canada)

- GRY
- Under right side of dash

### Connector A

- On dashboard wire harness B (right branch)



- |  |   |
|--|---|
| 1 RED (Top close (+) output, left motor)         | 8 BLK (G402)  |
| 2 RED/BLU (Top open (+) output, left motor)      | 9 RED/BLK (Top OPEN request)                                      |
| 3 GRY (Fuse 55)                                  | 10 RED/YEL (Top CLOSE request)                                    |
| 4 LT GRN/RED (Top close (+) output, right motor) | 11 BLK (G402)   |
| 5 RED/WHT (Top open (+) output, right motor)     | 12 GRN/WHT (Parking brake position circuit - Parking brake input) |
| 6 GRY/RED (Fuse 52)                              | 13 WHT/RED (Fuse 25)  |
| 7 BLK (G402)                                     | 14 BLU/BLK (Fuse 18)  |

### Connector B

- On dashboard wire harness A



- |   |   |
|---|---|
| 1 YEL (Fuse 5)  | 7 BLU/WHT (Passenger's window down request input) |
| 2 BLU/ORN (Driver's window down control output)                         | 8 BLU/RED (Passenger's window up request input)   |
| 3 RED/BLU (Passenger's window up (+))                                   | 9 RED/BLU (Passenger's window up redundant input) |
| 4 RED (Passenger's window down (+))                                     | 10 BLK (G501)                                     |
| 5 LT GRN (Hardtop CONNECTED signal (option))                            |   |
| 6 WHT/BLK (Vehicle speed sensor signal 1 circuit - vehicle speed input) |   |

## 179. Door Latch, Driver's

- GRY
- Driver's door
- On driver's door wire harness

### Connector A

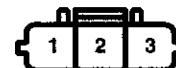

- 1 YEL/BLK (Knob switch LOCK output (-))
- 2 BLK (G501)
- 3 YEL (Knob switch UNLOCK output (-))

### Connector B



- 1 PNK/BLK (Lock signal (+))
- 2 YEL/GRN (Unlock signal (+))

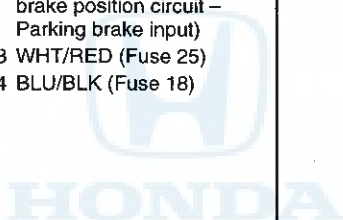

# Connector Terminal Views

## 180. ECM

– Behind left kick panel

### Connector A

– GRY  
– On engine wire harness

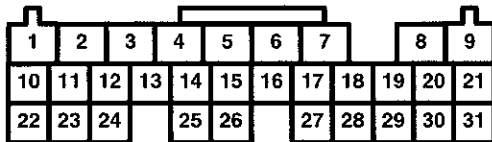

- |                     |                   |
|---------------------|-------------------|
| 1 RED/BLU (KS)      | 17 —              |
| 2 YEL/BLK (IGP2)    | 18 BLU/WHT (NC)   |
| 3 YEL/BLK (IGP1)    | 19 —              |
| 4 BLK (PG2)         | 20 YEL/BLU (VCC2) |
| 5 BLK (PG1)         | 21 YEL/RED (VCC1) |
| 6 GRN (CMP)         | 22 —              |
| 7 BLU (CKP)         | 23 GRN/YEL (SG2)  |
| 8 BRN/YEL (LG2)     | 24 GRN/WHT (SG1)  |
| 9 BRN/YEL (LG1)     | 25 RED/YEL (APSB) |
| 10 GRN (AFSHTC)     | 26 RED/BLU (APSA) |
| 11 —                | 27 —              |
| 12 —                | 28 RED/YEL (AFS-) |
| 13 WHT/BLU (IGPLS4) | 29 —              |
| 14 WHT/BLK (IGPLS3) | 30 GRN/RED (MAP)  |
| 15 WHT/GRN (IGPLS2) | 31 RED (AFS+)     |
| 16 WHT (IGPLS1)     |                   |

### Connector B

– WHT  
– On engine wire harness

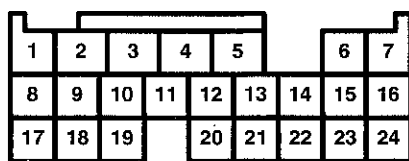

- |                    |                   |
|--------------------|-------------------|
| 1 —                | 13 WHT/RED (ALTF) |
| 2 YEL (INJ4)       | 14 —              |
| 3 BLU (INJ3)       | 15 —              |
| 4 RED (INJ2)       | 16 —              |
| 5 BRN (INJ1)       | 17 RED/YEL (IAT)  |
| 6 GRN/YEL (VTS)    | 18 WHT/GRN (ALTC) |
| 7 —                | 19 GRN (SEFD)     |
| 8 RED/WHT (ECT 1)  | 20 BLU (SEDF)     |
| 9 —                | 21 YEL/BLU (PCS)  |
| 10 WHT/BLU (ALTL)  | 22 —              |
| 11 BLU/BLK (VTPSW) | 23 —              |
| 12 —               | 24 —              |

### Connector D

– WHT  
– On dashboard wire harness A

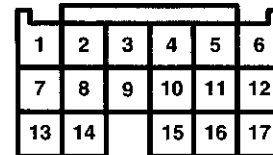

- |                            |                  |
|----------------------------|------------------|
| 1 LT GRN/RED<br>(CCSETSW)  | 9 PNK (CCCLSW)   |
| 2 —                        | 10 —             |
| 3 —                        | 11 —             |
| 4 LT GRN (CCMSW)           | 12 —             |
| 5 —                        | 13 —             |
| 6 —                        | 14 —             |
| 7 LT GRN/BLK<br>(CCSRESSW) | 15 BRN (ETCSRLY) |
| 8 GRY (BKSWNC)             | 16 —             |
|                            | 17 —             |

### Connector E

– WHT  
– On dashboard wire harness A

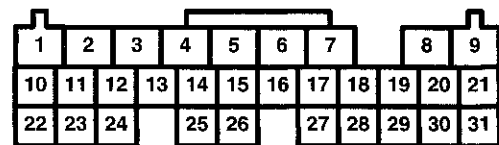

- |                     |   |
|---------------------|---|
| 1 BLU (ECT 2)       | 18 RED (ACC)  |
| 2 —                 | 19 LT GRN/WHT (VSV)                                       |
| 3 GRN/WHT (LG3)     | 20 RED (SHO2S)  |
| 4 GRN (SG3)         | 21 BLK/WHT (SO2SHTC)                                      |
| 5 YEL/BLU (VCC3)    | 22 WHT/BLK (BKSW)   |
| 6 —                 | 23 GRY (K-LINE)   |
| 7 GRN (MRLY)        | 24 WHT (CAN L)  |
| 8 ORN (AFSHTCR)     | 25 BLU (NEP)  |
| 9 BLK/YEL (IG1)     | 26 —  |
| 10 —                | 27 RED/BLU (IMOCD)  |
| 11 RED (CAN H)      | 28 USA: Base, CR Audio –<br>A/C; Canada: BLU/RED<br>(ACS) |
| 12 GRN (FAN C)      | 29 BRN (SCS)  |
| 13 YEL (SEFMJ)      | 30 GRN/WHT (WEN)  |
| 14 LT GRN (FTP)     | 31 —  |
| 15 GRN/RED (ELD)    |   |
| 16 BLU/BLK (EPSLD)  |   |
| 17 GRN/YEL (IMOFPR) |   |



## 181. EPS Control Unit

- GRN
- Right side of engine compartment

### Connector A

- On right engine compartment wire harness

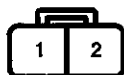

- 1 GRN (EPS motor (-))
- 2 RED (EPS motor (+))

### Connector B

- On right engine compartment wire harness

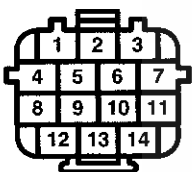

- |                                       |   |
|---------------------------------------|---|
| 1 YEL (Ignition input (IG1))          | 8 BRN (Service check input (SCS))           |
| 2 WHT/BLK (Vehicle speed pulse (VSP)) | 9 —   |
| 3 PNK (Voltage sensor 1 input (VS1))  | 10 —  |
| 4 BLK (G402)                          | 11 WHT/GRN (Voltage sensor 2 input (VS2))   |
| 5 BLU (Tachometer signal input (NEP)) | 12 YEL/BLU (Indicator light control (WLP))  |
| 6 BLK (G201)                          | 13 BLU/BLK (Power steering signal (PS-SIG)) |
| 7 BLU/RED (Torque sensor power (PVF)) | 14 LT BLU (Data link (DLC))                 |

### Connector C

- On EPS sub-harness



- 1 BLK (G351)
- 2 WHT/RED (Fuse 33)

## 182. Gauge Assembly

- Behind gauge assembly
- On dashboard wire harness A

### Connector A

- GRN



- |   |  |
|---|--|
| 1 YEL (Fuse 5)  | 14 GRN (Driver's door switch input (-))                                |
| 2 BLU/WHT (DRL indicator)   | 15 Canada: RED/WHT (High beam indicator (+))<br>USA: RED/WHT (Fuse 45) |
| 3 WHT/RED (Fuse 25)   | 16 Canada: RED/BLU<br>USA: YEL (High beam indicator (-))               |
| 4 PNK (Immobilizer indicator (-))   | 17 BLK (G501)  |
| 5 BLK/WHT (Door open output (-))  | 18 BLK (G501)  |
| 6 —   | 19 RED (Illumination (negative) circuit - Dash and console lights (-)) |
| 7 RED/YEL (Fuse 45)   | 20 BLK/YEL (Security indicator (-))                                    |
| 8 RED/BLK (Illumination (positive) circuit - Dash and console lights (+)) | 21 USA: Base, CR, CR Audio - A/C; Canada: RED (CAN2L)                  |
| 9 YEL (Fuse 5)  | 22 USA: Base, CR, CR Audio - A/C; Canada: WHT (CAN2H)                  |
| 10 WHT/RED (Fuse 25)  |  |
| 11 GRY (K-LINE)   |  |
| 12 BLU/BLK (Trunk indicator (-))  |  |
| 13 LT GRN/RED (Passenger's door switch input (-))                         |  |

(cont'd)

# Connector Terminal Views

## 182. Gauge Assembly (cont'd)

- Behind gauge assembly
- On dashboard wire harness A

### Connector B

- GRN



- |  |   |
|--|---|
| 1 —  | 17 BLU/BLK (Intermittent wiper request input)     |
| 2 BLK (Fuel gauge ground)                                      | 18 WHT/BLK (Washer request input)                 |
| 3 BLU (Tachometer signal output)                               | 19 PNK (SRS indicator circuit)                    |
| 4 BLU/RED (Seat belt reminder)                                 | 20 BLU/RED (VSA indicator circuit input)          |
| 5 BLK/YEL (SRS)  | 21 YEL/BLU (EPS indicator (-))                    |
| 6 RED/WHT (Ignition key switch input (-))                      | 22 PNK (Outside air temperature sensor)           |
| 7 BLU/WHT (Vehicle speed signal input (-))                     | 23 GRN/WHT (Parking brake switch input (-))       |
| 8 WHT/BLK (Vehicle speed pulse output)                         | 24 GRN/RED (Brake system indicator input (-))     |
| 9 BLK/WHT (Heater control panel illumination cancel output)    | 25 PNK (VSA)                                      |
| 10 YEL/BLK (Fuel gauge signal input)                           | 26 YEL (MIL control)                              |
| 11 GRN (VSA activation indicator)                              | 27 YEL/RED (Engine oil pressure switch input (-)) |
| 12 GRN (Intermittent wiper relay driver output (-))            | 28 BLK (Outside air temperature sensor)           |
| 13 YEL/BLU (Rear defogger)                                     | 29 GRN/RED (Left turn signal indicator (+))       |
| 14 PNK/BLK (VSA indicator)                                     | 30 GRN/YEL (Right turn signal indicator (+))      |
| 15 BLK/YEL (Rear defogger)                                     |   |
| 16 BLU/ORN (Intermittent wiper circuit - Wiper position input) |   |

## 183. High Beam Cut Relay and Rear Window Defogger Relay

- GRY
- Under left side of dash
- On dashboard wire harness B (left branch)

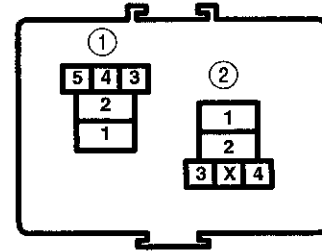

### ① Rear Window Defogger Relay:

- |                           |                     |
|---------------------------|---------------------|
| 1 WHT/GRN (Fuse 34)       | 4 —                 |
| 2 BLK/RED (Power)         | 5 YEL/BLK (Fuse 19) |
| 3 YEL/BLU (Relay control) |                     |

### ② High Beam Cut Relay:

- |  |   |
|--|---|
| 1 RED/BLU (High beam control output (-)) | 3 BLU/RED (Headlight request input (-)) |
| 2 ORN (High beam request input (-))      | 4 BLU (Fuse 45)                         |





## 184. Passenger's Weight Sensor Unit

- BLK/YEL
- Under passenger's seat
- On rear wire harness (right branch)

### Connector A:



- 1 RED (SWIP)
- 2 BLK (SWIG)

### Connector B:



- 1 RED (SWOP)
- 2 BLK (SWIG)

### Connector C:

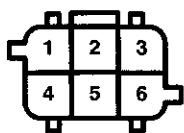

- 1 —
- 2 —
- 3 BLK/YEL (Fuse 2)
- 4 —
- 5 GRN (ODUS)
- 6 BLK (G601)

## 185. PGM-FI Main Relays 1 and 2

- BLU
- Under left side of dash
- On dashboard wire harness B (right branch)

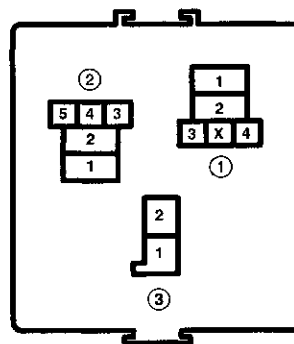

### ① PGM-FI Main Relay 1:

- 1 WHT/GRN (Fuse 46)
- 2 YEL/BLK (Power source for ECM circuit)
- 3 GRN (MRLY)
- 4 WHT/GRN (Fuse 46)

### ② PGM-FI Main Relay 2:

- 1 BLK/YEL (Fuse 2)
- 2 YEL/GRN (Fuel pump)
- 3 GRN/YEL (Fuel pump control)
- 4 —
- 5 YEL/BLK (Power source for ECM circuit)

# Connector Terminal Views

## 186. SRS Unit

- YEL
- Behind lower center of dash
- On SRS main wire harness

**Connector A**

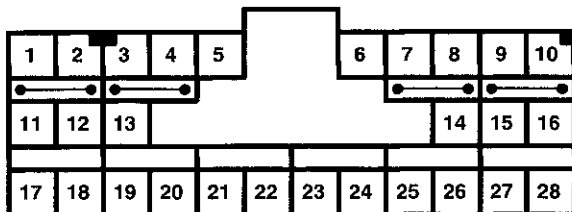

- |   |  |
|---|--|
| 1 GRN or BLU (Driver's second inflator)       | 12 BLU (PTT)                                 |
| 2 PUR or BLU (Driver's second inflator)       | 13 —   |
| 3 LT GRN or BLU (Passenger's second inflator) | 14 GRN or BLU (ODUS)                         |
| 4 LT BLU or BLU (Passenger's second inflator) | 15 BRN (Left front impact sensor)            |
| 5 LT GRN/BLK or BLU (MES)                     | 16 LT BLU or BLU (Right front impact sensor) |
| 6 BRN or BLU (Service check signal circuit)   | 17 BLK/YEL or BLU (VA)                       |
| 7 LT BLU or BLU (Driver's first inflator)     | 18 PNK or BLU (VB)                           |
| 8 BRN or BLU (Driver's first inflator)        | 19 —   |
| 9 YEL or BLU (Passenger's first inflator)     | 20 —   |
| 10 BLU (Passenger's first inflator)           | 21 BLK/YEL or BLU (SRS)                      |
| 11 PNK or BLU (IDC)                           | 22 GRN or BLK or BLU (G801)                  |
|   | 23 GRN or BLK or BLU (G801)                  |
|   | 24 GRY or BLU (K-LINE)                       |
|   | 25 —   |
|   | 26 —   |
|   | 27 RED or BRN (Left front impact sensor)     |
|   | 28 GRN or BLU (Right front impact sensor)    |

**Connector B**

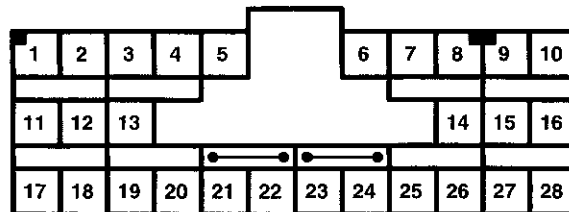

- |  |  |
|--|--|
| 1 RED or BLU (Seat belt tensioner – driver's)              | 13 —   |
| 2 BRN or BLU (Seat belt tensioner – driver's)              | 14 —   |
| 3 GRN or BLU (Seat belt tensioner – Passenger's)           | 15 BLU (Passenger's seat belt buckle switch (BSPL))        |
| 4 LT BLU or BLU (Seat belt tensioner – Passenger's)        | 16 ORN or BLU (Passenger's seat belt buckle switch (BSPH)) |
| 5 GRY or BLU (Driver's seat position sensor)               | 17 —   |
| 6 LT GRN or BLU (Driver's seat position sensor)            | 18 —   |
| 7 —  | 19 —   |
| 8 —  | 20 —   |
| 9 —  | 21 —   |
| 10 —   | 22 —   |
| 11 YEL or BLU (Driver's seat belt buckle switch (BSDL))    | 23 —   |
| 12 LT GRN or BLU (Driver's seat belt buckle switch (BSDH)) | 24 —   |
|  | 25 —   |
|  | 26 —   |
|  | 27 —   |
|  | 28 —   |

## 187. Accessory Power Socket Relay and Throttle Actuator Control Module Relay

- BLK
- Under left side of dash
- On dashboard wire harness B (left branch)

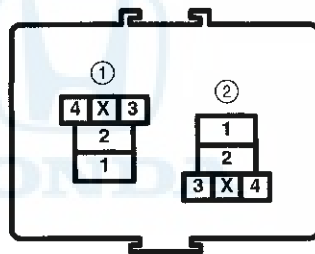

### ① Accessory Power Socket Relay:

- 1 WHT (Relay output)
- 2 BLU (Fuse 53)
- 3 BLK (G401)
- 4 WHT/RED (Fuse 9)

### ② Throttle Actuator Control Module Relay:

- 1 YEL/GRN (Electronic throttle control system)
- 2 BLU/WHT (Fuse 14)
- 3 BRN (Electronic throttle control system)
- 4 YEL/GRN (Fuse 11)

# Connector Terminal Views

## 188. Under-dash Fuse/Relay Box

– Under left side of dash

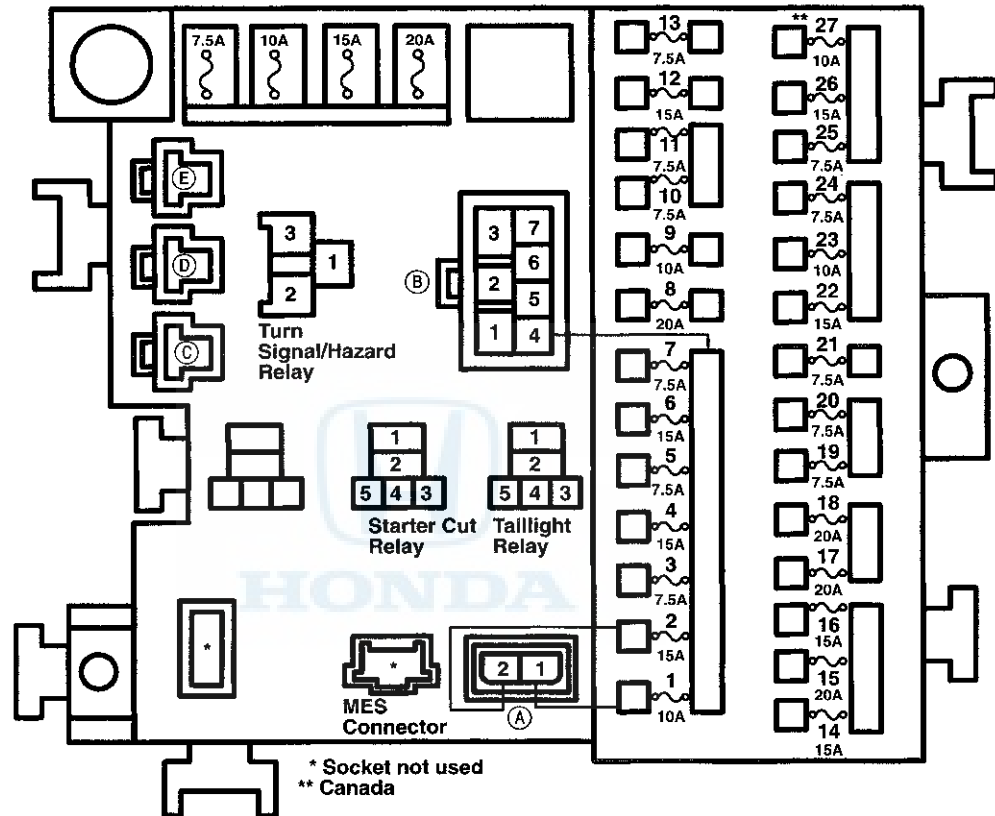

### Connector A

- Male – In under-dash fuse/relay box
- Female – YEL
- Connects under-dash fuse/relay box to SRS main wire harness

- 1 Male – Internal connection (Fuse 1)  
Female – BLU or PNK  
(SRS unit – Ignition input)
- 2 Male – Internal connection (Fuse 2)  
Female – BLU or BLK/YEL  
(SRS unit – Ignition input)

### Connector B

- Male – In under-dash fuse/relay box
- Female – BRN
- Connects under-dash fuse/relay box to ignition switch lead

- 1 WHT (Fuse 42 – Battery output)
- 2 ORN (Ignition switch – ON output)
- 3 BLK/RED (Ignition switch – ON output)
- 4 Male – Internal connection  
(Busbar – Fuses 1 through 7)  
Female – BLK/YEL  
(Ignition switch – ON output)
- 5 WHT/RED (Ignition switch – ACC or ON output)
- 6 WHT/BLK (Fuse 42 – Battery input)
- 7 BLK/YEL (Ignition switch – ON output)



### Connector C

– Option connector

- 1 Male – YEL (IG2 relay output)
- Female – —

### Connector D

– Option connector

- 1 Male – WHT: (Fuse 42 – battery input)
- Female – —

### Connector E

– Option connector

- 1 Male – RED/BLK (Illumination (positive) circuit – taillight relay output)
- Female – —

### Relays

#### Starter Cut Relay

- |  |  |
|--|--|
| 1 ORN (Ignition ON input)                | 4 —  |
| 2 BLK/WHT (Start output)                 | 5 BLU/WHT (Engine start switch signal circuit) |
| 3 LT BLU (Clutch pedal position circuit) |  |

#### Taillight Relay

- |  |                     |
|--|---------------------|
| 1 RED/BLK (Taillight relay output)         | 4 —                 |
| 2 WHT/GRN (Fuse 23)                        | 5 WHT/GRN (Fuse 23) |
| 3 BLU (Headlight or parking light request) |                     |

#### Turn Signal/Hazard Relay

- |   |   |
|---|---|
| 1 BLK/RED (Turn signal/hazard power supply) | 2 GRN/WHT (Ignition ON or hazard switch ON input) |
|   | 3 BLK (G401)                                      |

### Fuses

- 1 Internal connection—10A—internal connection
- 2 Internal connection—15A—internal connection
- 3 BLK/WHT—7.5A—internal connection
- 4 —
- 5 YEL—7.5A—internal connection
- 6 BLK/YEL—15A—internal connection
- 7 RED/BLU—7.5A—internal connection
- 8 GRN/BLK—20A—BLK/YEL
- 9 YEL/RED—10A—WHT/RED
- 10 YEL/BLU—7.5A—YEL/BLK
- 11 YEL/GRN—7.5A—YEL/BLK
- 12 BLK/WHT—15A—GRN/BLK
- 13 BLU/ORN—7.5A—BLU/WHT
- 14 BLU/WHT—15A—YEL
- 15 WHT/RED—20A—YEL
- 16 BLK/YEL—15A—YEL
- 17 GRN/WHT—20A—WHT/BLK
- 18 BLU/BLK—20A—WHT/BLK
- 19 YEL/BLK—7.5A—YEL
- 20 BLK/YEL—7.5A—YEL
- 21 RED—7.5A—YEL
- 22 WHT/BLU—15A—YEL
- 23 WHT/GRN—10A—YEL
- 24 WHT/BLU—7.5A—YEL
- 25 WHT/RED—7.5A—YEL
- 26 WHT—15A—YEL
- 27 RED/BLU—10A—YEL

# Connector Terminal Views

## 189. Under-hood Fuse/Relay Box, Main

- Right side of engine compartment
- On right engine compartment wire harness

### Connector A

- LT GRN

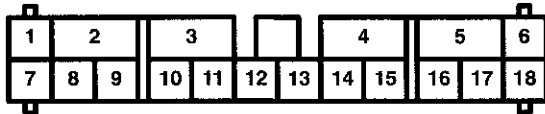

- |                        |                                     |
|------------------------|-------------------------------------|
| 1 —                    | 11 ORN (Horn relay control circuit) |
| 2 RED/YEL (Headlights) | 12 BLU/RED (Headlights)             |
| 3 RED/YEL (Headlights) | 13 —                                |
| 4 RED/WHT (Headlights) | 14 —                                |
| 5 —                    | 15 —                                |
| 6 WHT/RED (Fuse 48)    | 16 —                                |
| 7 —                    | 17 WHT/GRN (Fuse 46 – PGM-FI)       |
| 8 BLU/RED (Horns)      | 18 —                                |
| 9 BLU/RED (Horns)      |                                     |
| 10 —                   |                                     |

### Connector B

- BRN

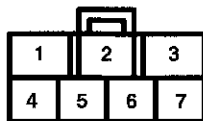

- |   |                     |
|---|---------------------|
| 1 WHT/BLU (Fuse 50)                         | 5 WHT/GRN (Fuse 47) |
| 2 GRY (Fuse 55)                             | 6 WHT/BLK (Fuse 51) |
| 3 GRY/RED (Fuse 52)                         | 7 YEL (Fuse 54)     |
| 4 WHT/BLK (Fuse 49 – Hazard warning lights) |                     |

### Connector C

- BRN

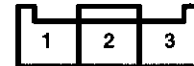

- |                  |
|------------------|
| 1 BLU/WHT (HVAC) |
| 2 WHT (Fuse 42)  |
| 3 BLU (Fuse 53)  |

### Connector D

- LT GRN

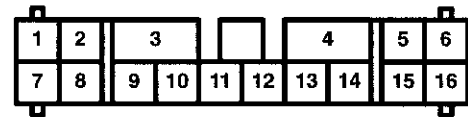

- |   |                      |
|---|----------------------|
| 1 BLK/YEL (Fuse 20)                                 | 8 —                  |
| 2 YEL (Fuse 59)                                     | 9 BLK/YEL (Fuse 20)  |
| 3 BLU/BLK (Fans)                                    | 10 —                 |
| 4 USA: Base, CR Audio – A/C; Canada: BLU/YEL (Fans) | 11 RED (HVAC)        |
| 5 —   | 12 GRN (Fans)        |
| 6 —   | 13 —                 |
| 7 USA: Base, CR Audio – A/C; Canada: BLU/RED (HVAC) | 14 BLK (G201)        |
|   | 15 —                 |
|   | 16 BLK/YEL (Fuse 20) |



## 190. XM Receiver (USA)

– Left side of trunk

### Connector A

- WHT
- On rear wire harness (left branch)

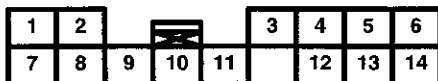

- |                              |                    |
|------------------------------|--------------------|
| 1 WHT/RED (Fuse 25)          | 8 —                |
| 2 WHT/RED (System Acc)       | 9 BLK (ECU BUS +)  |
| 3 ORN<br>(Bus shield ground) | 10 WHT (ECU BUS –) |
| 4 GRY (R+ shield)            | 11 BLK (G601)      |
| 5 WHT (R+)                   | 12 —               |
| 6 RED (L+)                   | 13 BLK (R–)        |
| 7 WHT/RED (Fuse 25)          | 14 GRN (L–)        |

### Connector B

- BLK
- On XM antenna (Honda Accessory)

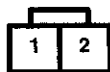

- 1 BLK (Terrestrial signal antenna)
- 2 BLK (Satellite signal antenna)

## 191. C51 (Honda Accessory)

- GRY
- Under left side of dash
- Connects hood switch harness (Honda Accessory) to security system harness (Honda Accessory)



- 1 YEL/RED  
(Security system)
- 2 —

## 192. C650

- GRY
- Under driver's seat
- Connects rear wire harness (left branch) to driver's seat position sensor sub-harness

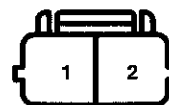

- 1 Male – WHT  
Female – LT GRN  
(SRS)
- 2 Male – BLK  
Female – GRY  
(SRS)

# Connector to Harness Index

## EPS Sub-harness

Ref	Connector or Terminal	Cavities/ Color	Location	Connects to	Notes
1	T1	2-GRY	Right side of engine compartment	Main under-hood fuse/relay box (see page 6-1)	
2	EPS control unit connector C		Right side of engine compartment		
3	G351		Right side of engine compartment	Body ground via EPS sub-harness	
7	T6	2-GRY	Left side of engine compartment	Auxiliary under-hood fuse box	
8	C351		Left side of engine compartment		
	⊕		Right side of engine compartment	Battery positive terminal	

## Battery Ground Cable

Ref	Connector or Terminal	Cavities/ Color	Location	Connects to	Notes
4	G1		Right side of engine compartment	Body ground via battery ground cable	
	⊖		Right side of engine compartment	Battery negative terminal	

## Starter Cable

Ref	Connector or Terminal	Cavities/ Color	Location	Connects to	Notes
5	G3		Left side of engine compartment	Body ground via starter cable	
6	T7		Left side of engine compartment	Auxiliary under-hood fuse box	
9	T2		Left side of engine	Starter motor	
11	T3		Left side of engine	Engine block	

## Engine Ground Cable

Ref	Connector or Terminal	Cavities/ Color	Location	Connects to	Notes
10	T5		Left side of engine	Engine block	
12	G2		Left side of engine	Rear beam ground via engine ground cable	

## EPS Gearbox Ground Cable

Ref	Connector or Terminal	Cavities/ Color	Location	Connects to	Notes
13	T4		Engine compartment (below front beam)	EPS gearbox	
14	G4		Engine compartment (below front beam)	Front beam ground via EPS gearbox ground cable	



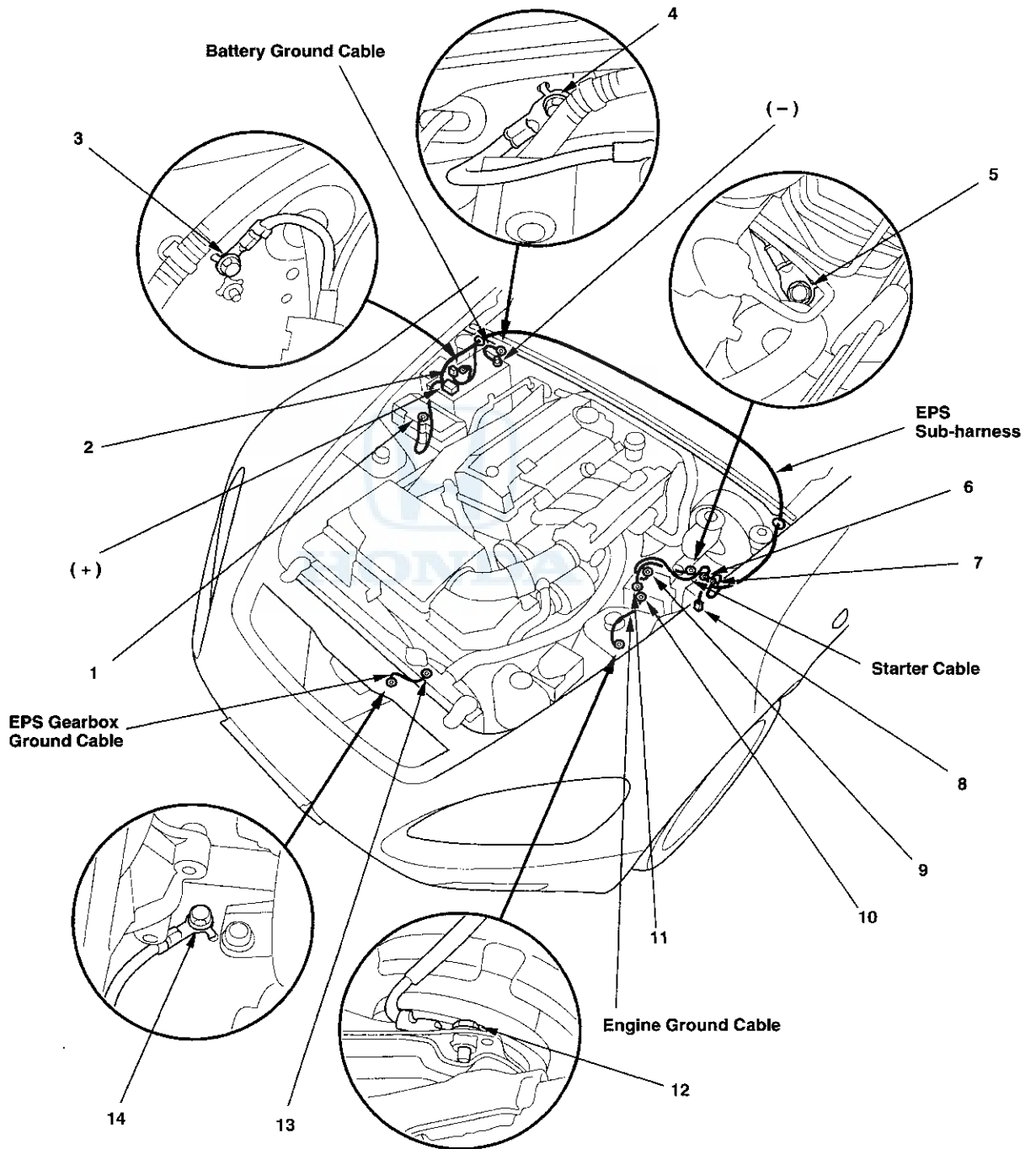

# Connector to Harness Index

## Engine Wire Harness

Ref	Connector or Terminal	Cavities/ Color	Location	Connects to	Notes
1	T101		Right side of engine compartment	Main under-hood fuse/relay box (see page 6-1)	
2	Rocker arm oil control solenoid (VTEC solenoid valve)	1-GRY	Right side of engine		
3	Ignition coil No. 1	3-BLU	Middle of engine		
4	Ignition coil No. 2	3-BLU	Middle of engine		
5	Ignition coil No. 3	3-BLU	Middle of engine		
6	CMP sensor	3-BLK	Rear of engine		
7	Ignition coil No. 4	3-BLU	Middle of engine		
8	G101		Rear of engine	Engine ground via engine wire harness	
9	A/F sensor	4-GRY	Left side of transmission		
10	Back-up light switch	2-GRY	Left side of transmission		
11	Secondary HO2S	4-GRY	Left side of transmission		
12	Output shaft (countershaft) speed sensor	3-BLK	Left side of transmission		
13	C102	6-WHT	Behind left kick panel	Dashboard wire harness A (see page 203-12)	
14	C101	16-LT BLU	Behind left kick panel	Dashboard wire harness A (see page 203-12)	
15	ECM connector A	31-GRY	Behind left kick panel		
16	ECM connector B	24-WHT	Behind left kick panel		
17	C103	13-WHT	Behind left kick panel	Dashboard wire harness A (see page 203-12)	
18	C104 (Junction connector)	20-PNK	Behind left kick panel		
19	Injector No. 4	2-BLU	Middle of engine		
20	Starter solenoid	1-BLK	Left side of engine		
21	TP sensor/throttle actuator	6-BLK	Left side of engine		
22	MAP sensor	3-BLK	Left side of engine		
23	A/C compressor	1-GRY	Left side of engine		
24	Alternator	4-BLU	Left side of engine		
25	T102		Left side of engine	Alternator	
26	Knock sensor	1-BLK	Left side of engine		
27	Injector No. 2	2-BLU	Middle of engine		
28	C105	3-BLK	Middle of engine	CKP sensor sub-harness (see this page)	
30	Injector No. 1	2-BLU	Middle of engine		
31	Injector No. 3	2-BLU	Middle of engine		
32	ECT sensor 1	2-BLK	Rear of engine		
33	T103		Right side of engine		
34	Rocker arm oil pressure switch (VTEC oil pressure switch)	2-GRY	Right side of engine		

\*1 = USA: Base, CR Audio – A/C; Canada

## CKP Sensor Sub-harness

Ref	Connector or Terminal	Cavities/ Color	Location	Connects to	Notes
28	C105 (Male)	3-BLK	Middle of engine	Engine wire harness (see this page)	
29	CKP sensor	3-GRY or BLK	Front of engine		

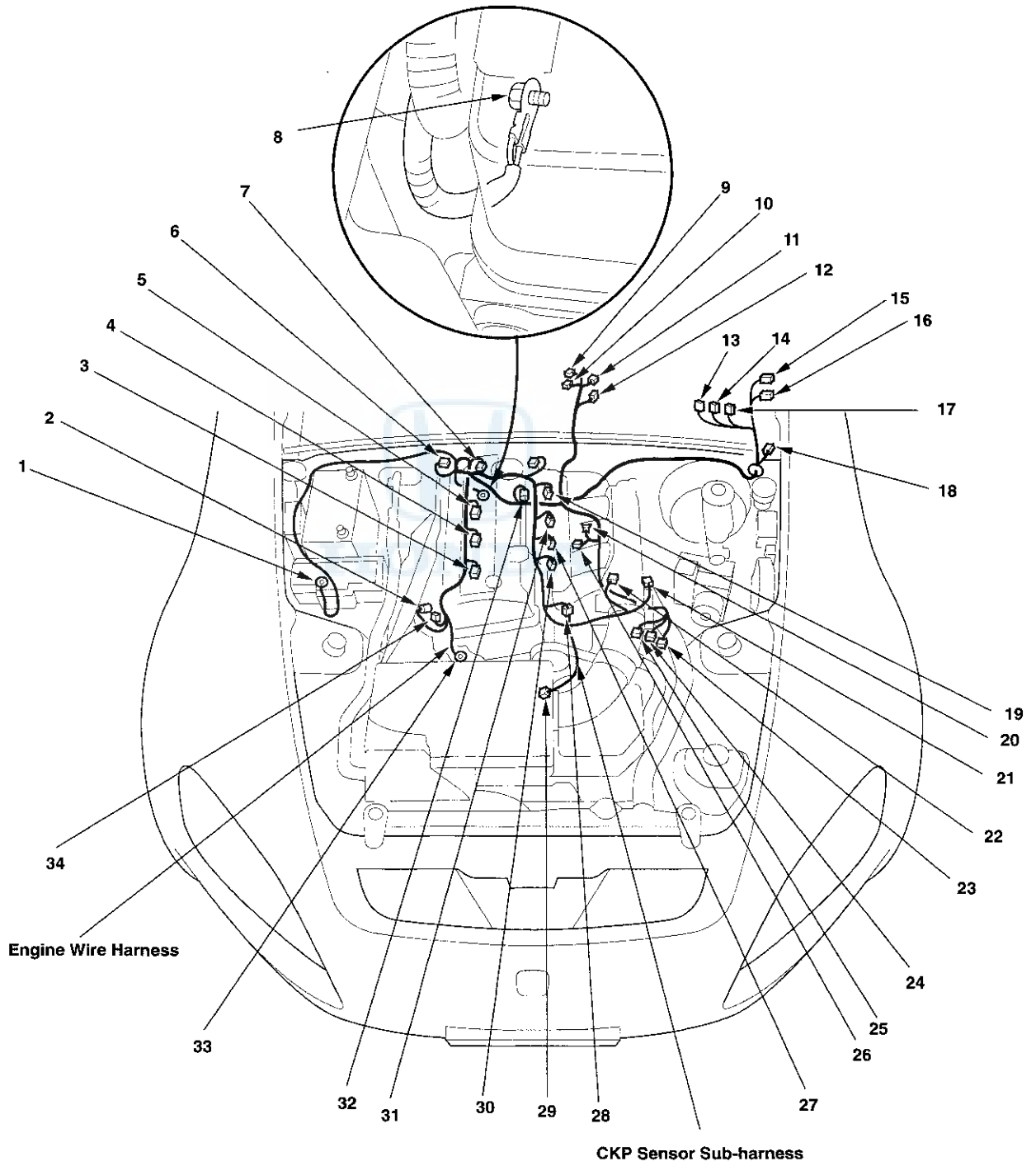

# Connector to Harness Index

## Right Engine Compartment Wire Harness

Ref	Connector or Terminal	Cavities/ Color	Location	Connects to	Notes
1	A/C condenser fan motor	2-GRY	Left side of engine compartment	Body ground via right-side engine compartment wire harness	*1
2	EPS torque sensor	3-GRY	Left side of engine compartment		
3	EPS motor	2-GRY	Engine compartment (below front beam)		
4	A/C pressure switch	2-GRY	Behind center of front bumper		
5	Outside air temperature sensor	2-GRY	Behind center of front bumper		
6	Low horn	1-BLK	Behind center of front bumper		
7	Radiator fan motor	2-GRY	Right side of engine compartment		
8	G201		Right side of engine compartment		
9	Right headlight, high beam	3-BLK	Behind right headlight		
10	Right headlight, low beam	2-GRY	Behind right headlight		
11	Right front wheel speed sensor	2-ORN	Right side of engine compartment		
12	Right front impact sensor	2-YEL	Right side of engine compartment		
13	Right front parking/side marker light	2-BRN/ NAT	Behind right headlight		
14	Right front turn signal light	2-GRY	Behind right headlight	Under-hood fuse/relay box	
15	High horn	1-BLK	Right side of engine compartment		
16	ELD unit (see page 6-1)	3-GRY	Right side of engine compartment		
17	EPS control unit connector A	2-GRY	Right side of engine compartment		
18	Windshield washer motor	2-BRN/ NAT	Behind right front wheel well		
19	EPS control unit connector B	14-GRY	Right side of engine compartment		
20	Right side turn signal light	2-BRN/ NAT	Behind right fender	Dashboard wire harness A (see page 203-12)	
21	C204	20-WHT	Under right side of dash		
22	C203	7-BRN	Under right side of dash		
23	C201	16- LT BLU	Under right side of dash		
24	C202	8-WHT	Under right side of dash		
25	C205	4-YEL	Under right side of dash	Dashboard wire harness B (right branch) (see page 203-10)	
26	Main under-hood fuse/relay box connector D (see page 6-1)	16- LT GRN	Right side of engine compartment	Dashboard wire harness B (right branch) (see page 203-10)	
27	Main under-hood fuse/relay box connector C (see page 6-1)	3-BRN	Right side of engine compartment	SRS main wire harness (see page 203-17)	
28	Main under-hood fuse/relay box connector B (see page 6-1)	7-BRN	Right side of engine compartment		
29	Main under-hood fuse/relay box connector A (see page 6-1)	18-LT GRN	Right side of engine compartment		

\*1 = USA: Base, CR Audio – A/C; Canada

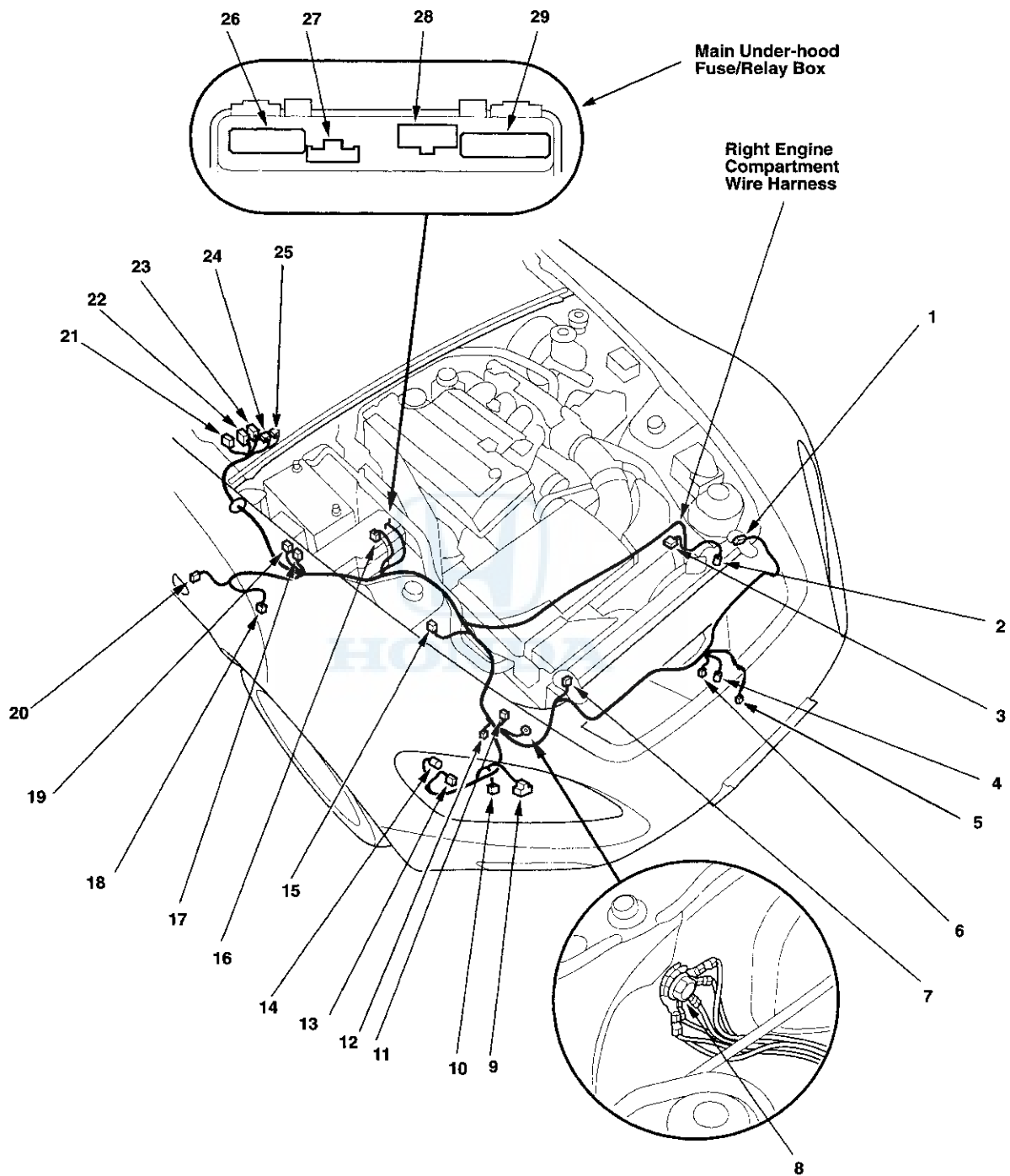

# Connector to Harness Index

## Left Engine Compartment Wire Harness

Ref	Connector or Terminal	Cavities/ Color	Location	Connects to	Notes
1	ECT sensor 2	2-BLK	Left side of engine compartment	Body ground via left-side engine compartment wire harness	
2	G301		Left side of engine compartment		
3	Left headlight, high beam	3-BLK	Behind left headlight	Body ground via left-side engine compartment wire harness	
4	Left headlight, low beam	2-GRY	Behind left headlight		
5	Left front impact sensor	2-YEL	Left side of engine compartment		
6	Left front turn signal light	2-GRY	Behind left headlight		
7	Left front wheel speed sensor	2-ORN	Left side of engine compartment		
8	Left front parking/side marker light	2-BRN/ NAT	Behind left headlight		
9	APP sensor	6-BLK	Left side of engine compartment		
10	Auxiliary under-hood fuse box connector B (see page 6-7)	3-BRN/ NAT	Left side of engine compartment		
11	G303		Left side of engine compartment	Body ground via left-side engine compartment wire harness	
12	Left side turn signal light	2-BRN/ NAT	Behind left fender	Dashboard wire harness B (left branch) (see page 203-8) Dashboard wire harness A (see page 203-12) SRS main wire harness Dashboard wire harness A (see page 203-12) Dashboard wire harness B (left branch) (see page 203-8)	
13	Intermittent wiper relay	6-BRN/ NAT	Left side of engine compartment		
14	Test tachometer connector	2-BLK	Left side of engine compartment		
15	Brake fluid level switch	2-GRY	Left side of engine compartment		
16	C301	14-GRY	Under left side of dash		
17	C304	8-WHT	Under left side of dash		
18	C305	4-YEL	Under left side of dash		
19	C303	20-WHT	Under left side of dash		
20	C302	16- LT BLU	Under left side of dash		
21	Windshield wiper motor	5-GRY	Under left side of windshield		
22	Auxiliary under-hood fuse box connector A (see page 6-7)	2-BRN/ BLK	Left side of engine compartment	Auxiliary under-hood fuse box	
23	C351	2-GRY	Left side of engine compartment	EPS sub-harness (see page 203)	
24	VSA modulator-control unit	47-BLK	Left side of engine compartment		
25	EVAP canister purge valve	2-BLK	Left side of engine compartment		
26	IAT sensor	2-BLK	Middle of engine		



**Left Engine  
Compartment  
Wire Harness**

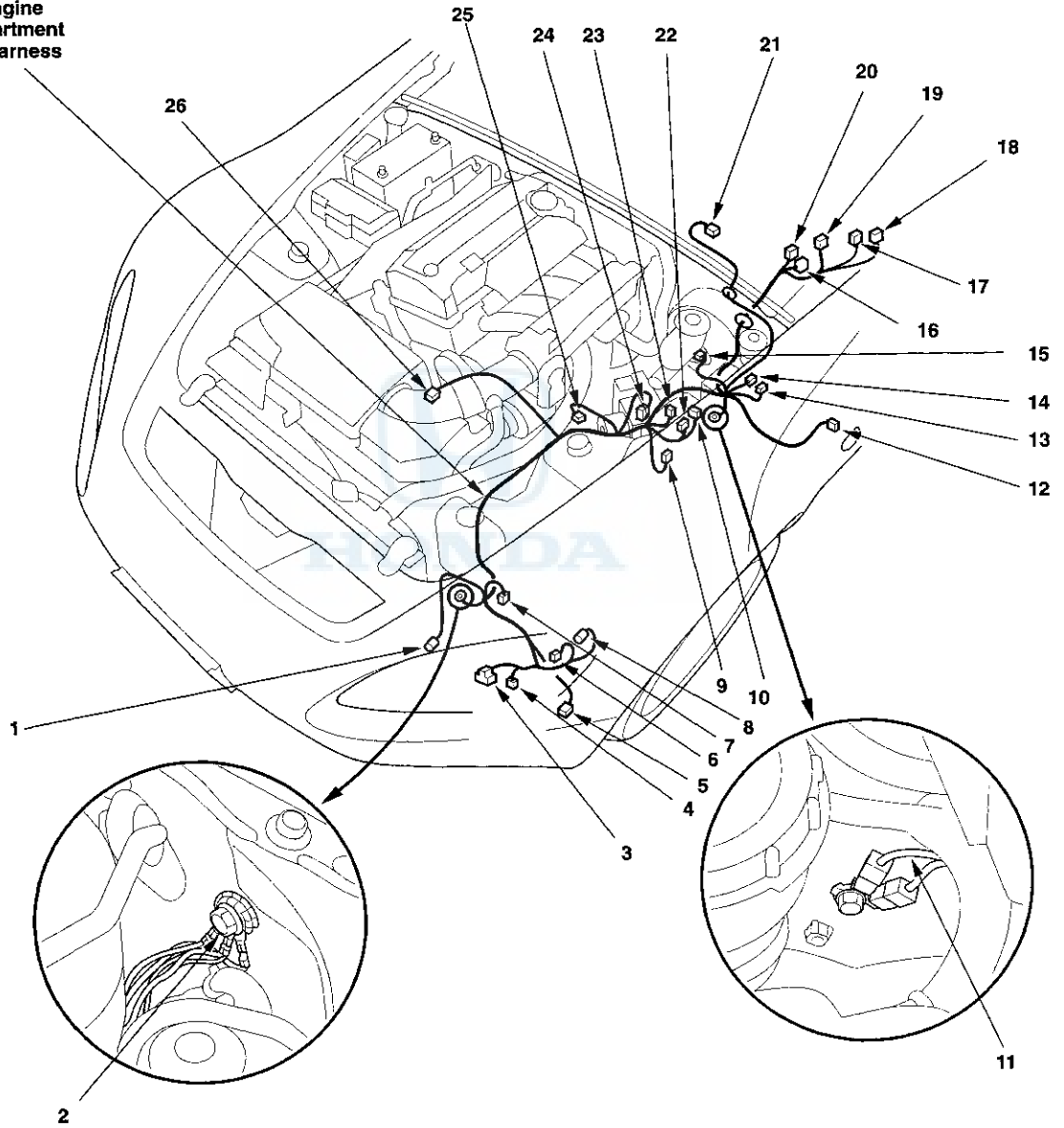

## Connector to Harness Index

### Dashboard Wire Harness B (Left Branch)

Ref	Connector or Terminal	Cavities/ Color	Location	Connects to	Notes	
1	Wiper/washer switch	14-GRY	In steering column cover	Rear wire harness (left branch) (see page 203-14) Body ground via dashboard wire harness B		
2	Immobilizer control unit-receiver	7-WHT	In steering column cover			
3	Ignition key switch	7-GRN	In steering column cover			
4	TPMS control unit	20-GRY	Under left side of dash			
5	C401	22-GRY	Behind left kick panel			
6	G401		Under left side of dash			
7	C405 (Junction connector)	12-BRN	Under left side of dash			
8	Accessory power socket relay	4-BLK	Under left side of dash			
9	Throttle actuator control module relay	4-BLK	Under left side of dash			
10	High beam cut relay	4-GRY	Under left side of dash			
11	Rear window defogger relay	5-GRY	Under left side of dash			
12	Clutch pedal position switch	2-NAT	Under left side of dash			
13	Clutch interlock switch	2-YEL	Under left side of dash			
14	C301	14-GRY	Under left side of dash			Left engine compartment wire harness (see page 203-6) Left engine compartment wire harness (see page 203-6)
15	C302	16- LT BLU	Under left side of dash			
16	Brake pedal position switch	4-WHT	Under left side of dash			Dashboard wire harness A (see page 203-12)
17	C404	24- LT BLU	Under left side of dash			
18	C403	16- LT BLU	Under left side of dash			Dashboard wire harness A (see page 203-12)
19	C402	6-LT BLU	Under left side of dash			
20	Combination light switch	16-GRY	In steering column cover			Dashboard wire harness A (see page 203-12)
21	Cable reel connector B	3-GRY	In steering column cover			
22	Steering angle sensor	5-GRN	In steering column cover			



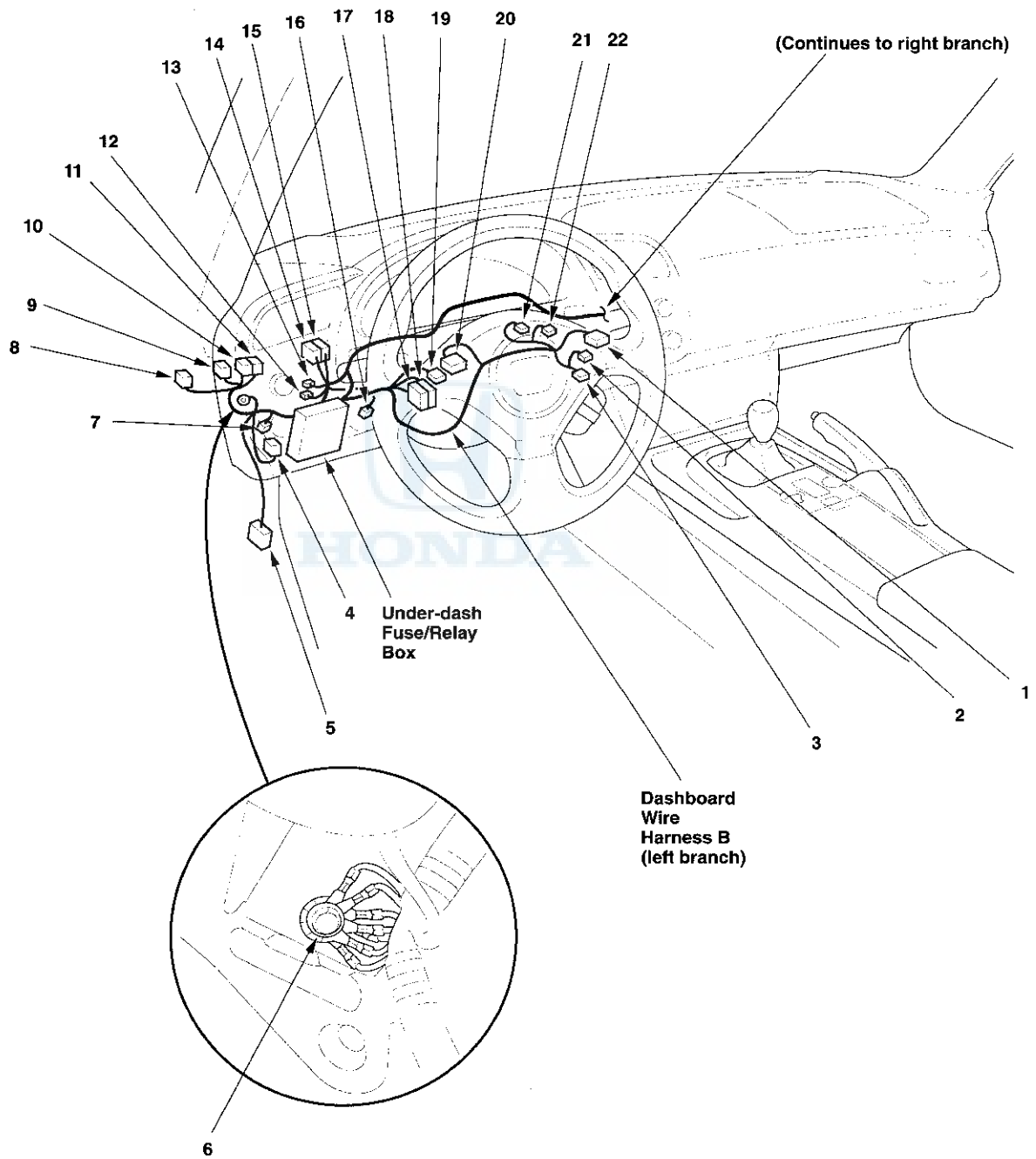

# Connector to Harness Index

## Dashboard Wire Harness B (Right Branch)

Ref	Connector or Terminal	Cavities/ Color	Location	Connects to	Notes
1	Ignition coil relay	4-BLK	Under left side of dash		
2	A/F sensor relay	4-BLK	Under left side of dash		
3	PGM-FI main relay 1	4-BLU	Under left side of dash		
4	DRL diode 2	3-WHT	Under middle of dash		USA
5	DRL diode 1	2-BLK	Under middle of dash		
6	DRL control unit	14-WHT/ GRY	Under left side of dash		
7	DRL sub-control unit	14-GRY	Under left side of dash		USA
8	Mode control motor	7-GRN	Under left middle of dash		
9	Air mix control motor	7-GRN	Under right side of dash		
10	Evaporator temperature sensor	2-GRY	Under right side of dash		*2
11	Blower power transistor	5-NAT	Under right side of dash		
12	Convertible top control unit connector A	14-GRY	Under right side of dash		*1
13	Blower motor	2-NAT	Under right side of dash		
14	Recirculation control motor	7-GRN	Under right side of dash		
15	C453	12-WHT	Under right side of dash	Dashboard wire harness A (see page 203-12)	
16	C203	7-BRN	Under right side of dash	Right engine compartment wire harness (see page 203-4)	
17	C201	16- LT BLU	Under right side of dash	Right engine compartment wire harness (see page 203-4)	
18	C451	16- LT BLU	Under right side of dash	Dashboard wire harness A (see page 203-12)	
19	Imoes unit	5-GRN	Under right side of dash		
20	G402		Under right side of dash	Body ground via dashboard wire harness B	
21	C452	2-GRY	Under right side of dash	Roof wire harness (see page 203-16)	
22	Convertible top motor emergency connector	2-GRY	Under right side of dash		*1
23	C202	8-WHT	Under right side of dash	Right engine compartment wire harness (see page 203-4)	
24	Parking brake switch	2-GRY	Below center of console		
25	Hazard warning switch	10-GRY	Below center of console		
26	Rear window defogger switch	6-BLU	Below center of console		
27	Convertible top switch	6-GRY	Below center of console		*1
28	DLC	16-GRY	Under left middle of dash		
29	IG2 relay	5-GRY	Under left side of dash		
30	ACC cut relay	5-GRY	Under left side of dash		
31	PGM-FI main relay 2	5-BLU	Under left side of dash		

\*1 = USA: Base; Canada

\*2 = USA: Base, CR Audio -- A/C; Canada

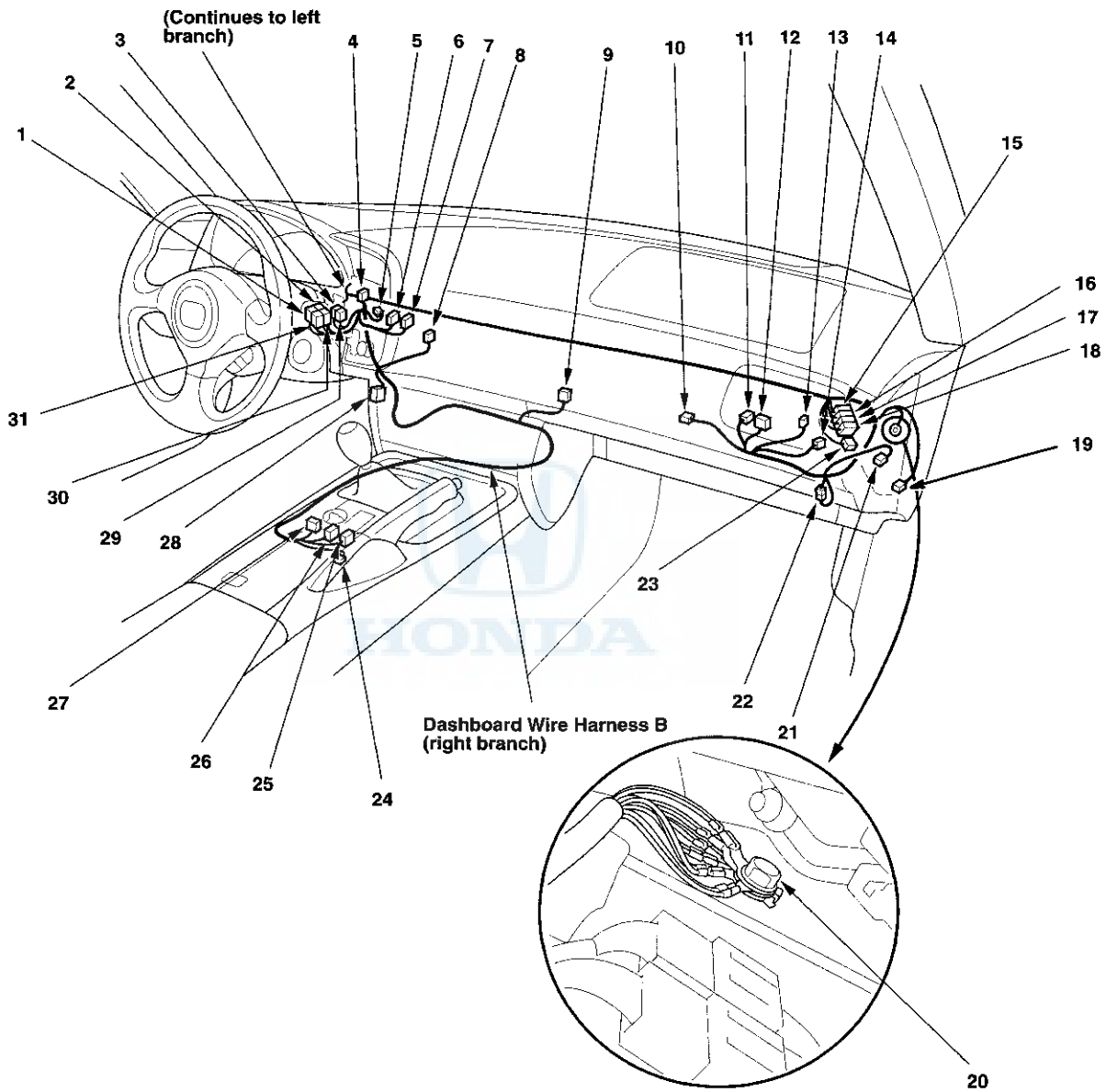

# Connector to Harness Index

## Dashboard Wire Harness A

Ref	Connector or Terminal	Cavities/ Color	Location	Connects to	Notes
1	C505	12-WHT	Behind left kick panel	Rear wire harness (left branch) (see page 203-14)	
2	C501	28-WHT	Behind left kick panel	Rear wire harness (left branch) (see page 203-14)	
3	C502	20-GRY	Behind left kick panel	Driver's door wire harness (See page 203-18)	
4	C101	16- LT BLU	Behind left kick panel	Engine wire harness (see page 203-2)	
5	C102	6-WHT	Behind left kick panel	Engine wire harness (see page 203-2)	
6	C103	13-WHT	Behind left kick panel	Engine wire harness (see page 203-2)	
7	Engine start switch	5-GRN	Left of steering wheel		
8	Security LED connector	2-WHT	Behind left kick panel	Security control unit (Honda Accessory)	
9	Keyless door lock control unit	18-GRY/ WHT	Under left side of dash		
10	Audio remote switch	6-GRN	Left of steering wheel		*2
11	ECM connector D	17-WHT	Behind left kick panel		
12	ECM connector E	31-WHT	Behind left kick panel		
13	Cruise control main switch	6-NAT	Left of steering wheel		
14	C403	16- LT BLU	Under left side of dash	Dashboard wire harness B (left branch) (see page 203-8)	
15	C404	24- LT BLU	Under left side of dash	Dashboard wire harness B (left branch) (see page 203-8)	
16	Gauge assembly connector B	30-GRN	Behind gauge assembly		
17	Gauge assembly connector A	22-GRN	Behind gauge assembly		
18	Heater control panel	30-GRN	Right of steering wheel		
19	Passenger's air bag cut-off indicator	4-GRN	Center of dash		
20	Audio unit connector A	20-LT BLU	Behind audio unit		*2
21	C551	2-GRY	Behind lower center of dash	Antenna amplifier sub-harness (see page 203-16)	*2
22	C453	12-WHT	Under right side of dash	Dashboard wire harness B (right branch) (see page 203-10)	
23	Convertible top control unit connector B	10-GRY	Under right side of dash		*1
24	C451	16- LT BLU	Under right side of dash	Dashboard wire harness B (right branch) (see page 203-10)	
25	C204	20-WHT	Under right side of dash	Right engine compartment wire harness (see page 203-4)	
26	C504	16-GRY	Under right side of dash	Passenger's door wire harness (see page 203-19)	
27	C507 (Junction Connector)	12-BLU	Under right side of dash		
28	Throttle actuator control module	16-GRY	Under right side of dash		
29	Audio unit connector B	14-WHT	Behind audio unit		USA
30	VSA off switch	6-NAT	Right of steering wheel		
31	C304	8-WHT	Under left side of dash	Left engine compartment wire harness (see page 203-6)	
32	C303	20-WHT	Under left side of dash	Left engine compartment wire harness (see page 203-6)	
33	C402	6-LT BLU	Under left side of dash	Dashboard wire harness B (left branch) (see page 203-8)	
34	C503	6-YEL	Under left side of dash	SRS main wire harness (see page 203-17)	
35	G502		Under right side of dash	Body ground via dashboard wire harness A	
36	G501		Behind left kick panel	Body ground via dashboard wire harness A	

\*1 = USA: Base; Canada

\*2 = USA: Base, CR Audio – A/C; Canada

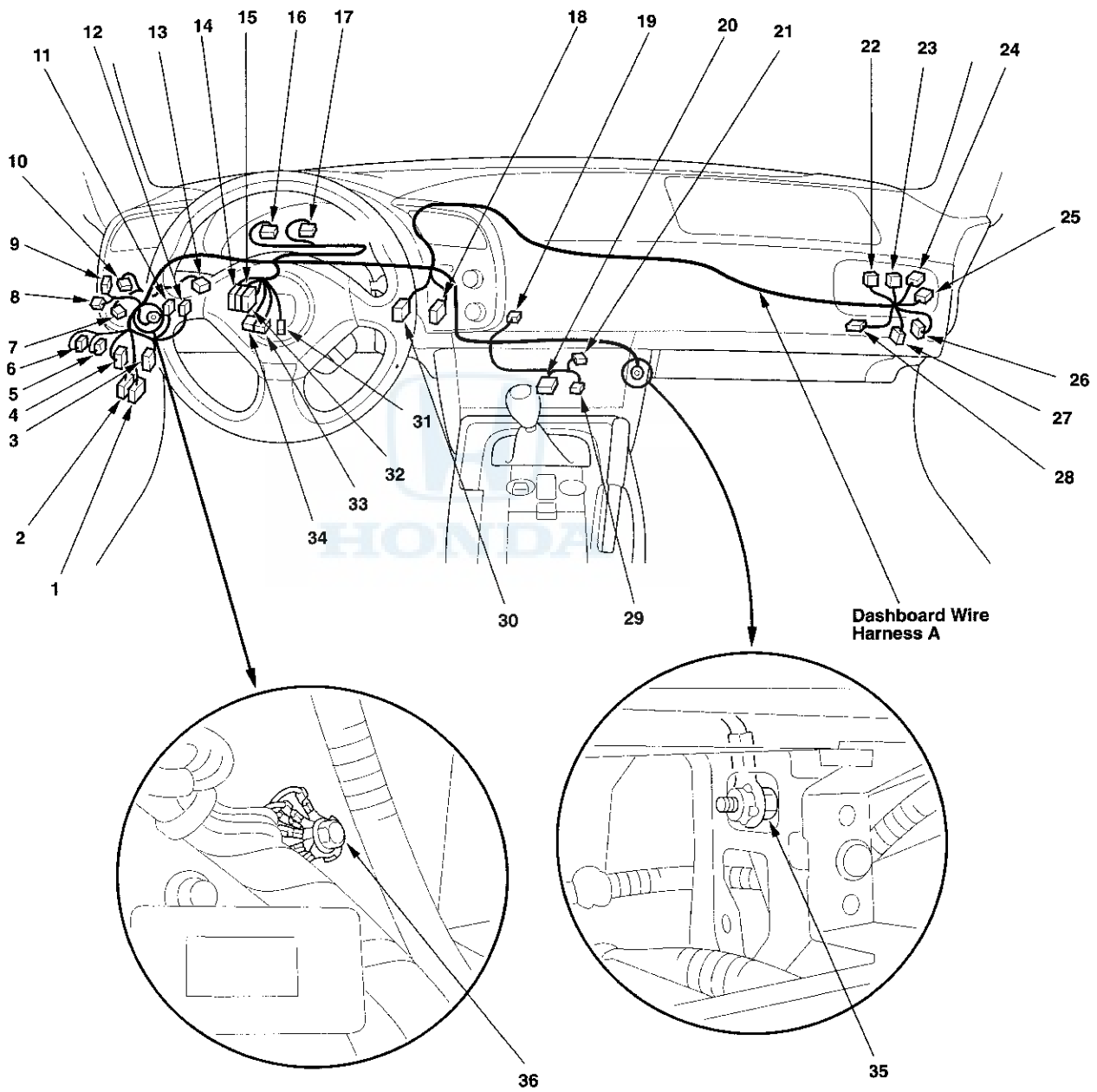
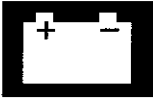

# Connector to Harness Index

## Rear Wire Harness (Left Branch)

Ref	Connector or Terminal	Cavities/Color	Location	Connects to	Notes
1	C401	22-GRY	Behind left kick panel	Dashboard wire harness B (left branch) (see page 203-8)	
2	C501	28-WHT	Behind left kick panel	Dashboard wire harness A (see page 203-12)	
3	Driver's seat belt buckle switch	3-GRY/BLU	Under driver's seat		
4	Driver's door switch	1-NAT	Behind left side rear trim		
5	Left convertible top motor	2-BRN	Behind left side rear trim		*2
6	C601	3-GRY	Under driver's roll bar	Hardtop sub-harness (see page 203-20)	
7	Left rear wheel speed sensor	2-ORN	Left side of trunk		
8	FTP sensor	3-BLK	Under left side of floor		
9	EVAP canister vent shut valve	2-BLK	Under left side of floor		
10	Noise condenser	2-GRY	Left side of trunk		
11	Rear window defogger diode	2-BLK	Left side of trunk		*2
12	Rear window defogger change relay	5-GRY	Left side of trunk		*2
13	C602	2-BRN	Left side of trunk	Rear window defogger sub-harness (softtop) (see page 203-21)	Softtop
14	Left brake/side marker/taillight	3-GRY	Behind left taillight assembly		
15	Left rear turn signal light	2-GRY	Behind left taillight assembly		
16	Left back-up light	2-GRY	Behind left taillight assembly		
17	Trunk lid opener solenoid/latch switch	3-GRY	Middle of trunk lid		
18	High mount brake light	2-GRY	Middle of trunk lid		
19	XM receiver connector A	14-WHT	Left side of trunk		USA
20	Trunk light	2-GRY	Upper middle of trunk		
21	G601		Left side of trunk	Body ground via rear wire harness	
22	Fuel tank unit	5-GRY	Middle of fuel tank		
23	C603	8-GRY	Behind rear of console	SRS main wire harness (see page 203-17)	
24	Trunk lid opener switch	2-NAT	Behind rear of console		
25	VSA sensor cluster	6-BLK/GRY	Behind rear of console		
26	Driver's left rear speaker	2-BLK	Under driver's roll bar		*1
27	Driver's right rear speaker	3-BLK	Under driver's roll bar		*1
28	C650	2-GRY	Under driver's seat	Driver's seat position sensor	
29	C505	12-WHT	Behind left kick panel	Dashboard wire harness A (see page 203-12)	USA

\*1 = USA: Base, CR Audio – A/C; Canada

\*2 = USA: Base; Canada

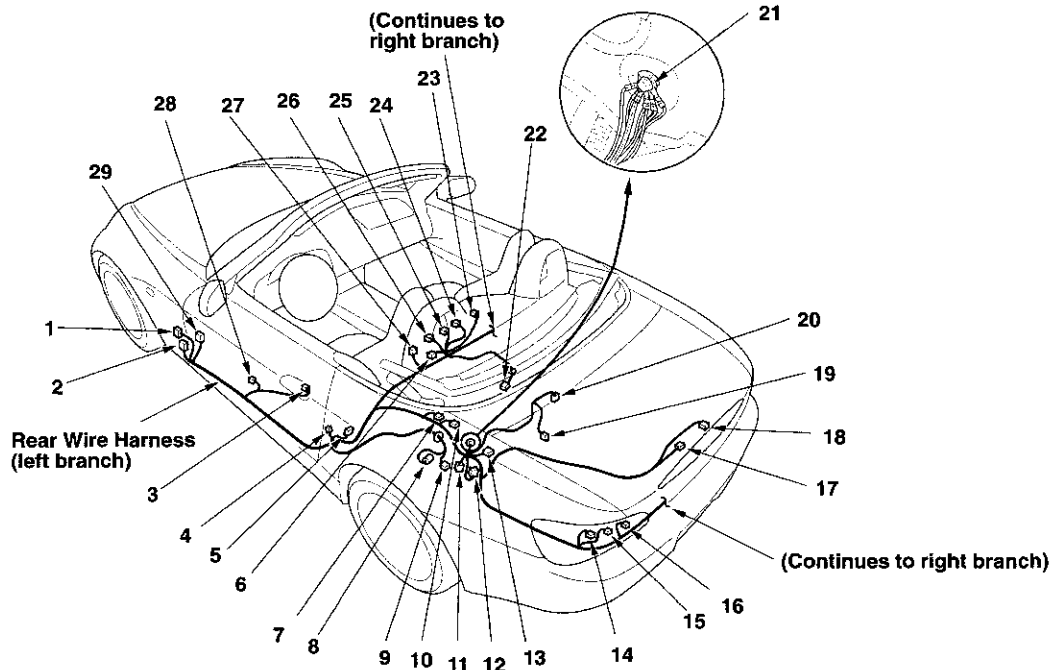

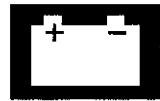

### Rear Wire Harness (Right Branch)

Ref	Connector or Terminal	Cavities/Color	Location	Connects to	Notes
1	Passenger's seat belt buckle switch	3-BLU	Under passenger's seat		
2	Passenger's weight sensor unit connector C	6-BLK/ YEL	Under passenger's seat		
3	Passenger's left rear speaker	3-BLK	Under passenger's roll bar		*1
4	Passenger's door switch	1-NAT	Behind right side rear trim		
5	Right convertible top motor	2-BRN	Behind right side rear trim		*2
6	Accessory power socket	2-BLK	Behind rear of console		
7	Right rear wheel speed sensor	2-ORN	Right side of trunk		
8	Passenger's right rear speaker	2-BLK	Under passenger's roll bar		*1
9	Right brake/side marker/taillight	3-GRY	Behind right taillight assembly		
10	Right rear turn signal light	2-GRY	Behind right taillight assembly		
11	Right back-up light	2-GRY	Behind right taillight assembly		
12	License plate light	2-BRN/ NAT	Center of rear bumper		
13	G602		Left side of trunk	Body ground via rear wire harness	

\*1 = USA: Base, CR Audio – A/C; Canada

\*2 = USA: Base; Canada

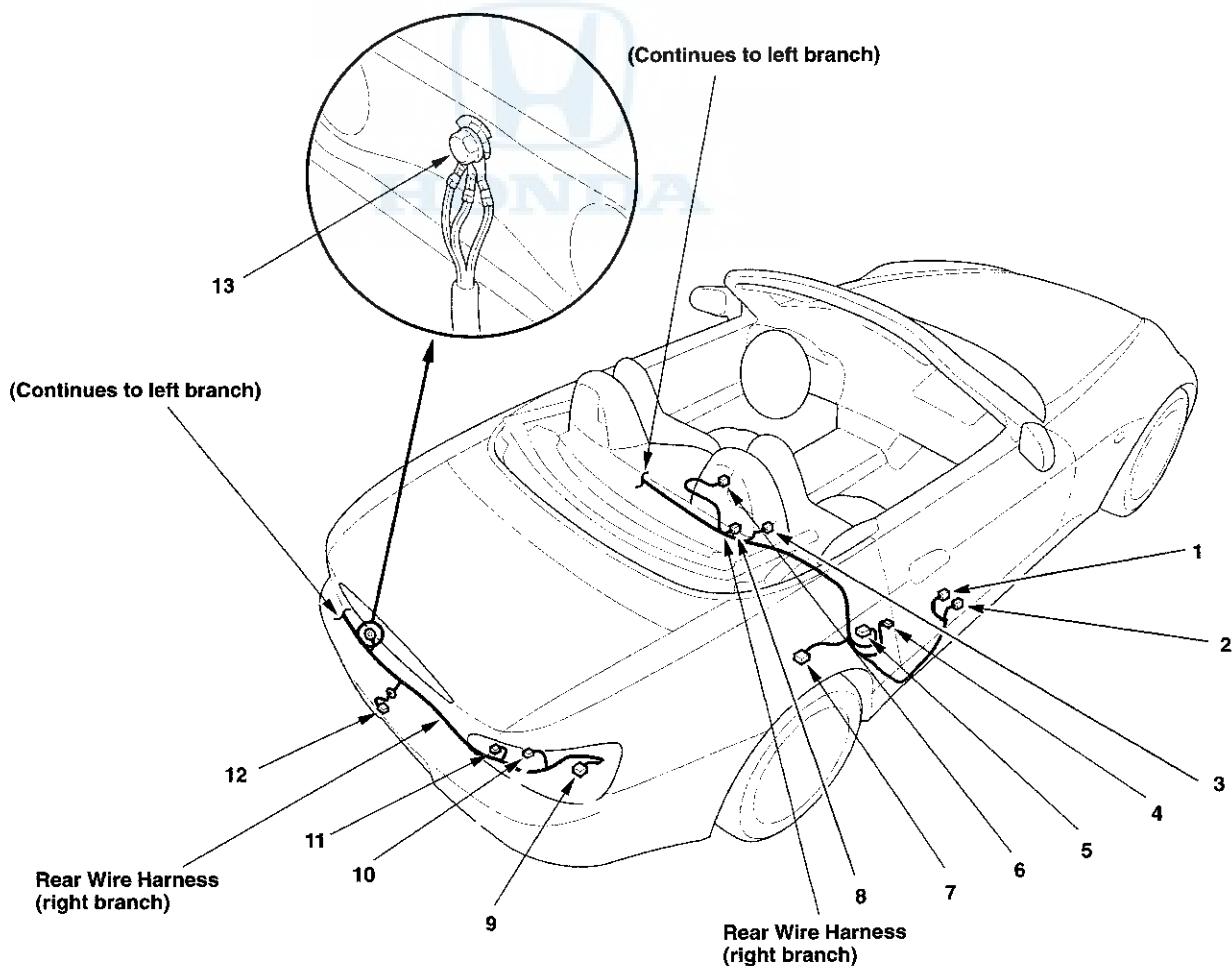

# Connector to Harness Index

## Roof Wire Harness

Ref	Connector or Terminal	Cavities/ Color	Location	Connects to	Notes
1	Ceiling light/spotlights	4-NAT	Center of front roof rail trim	Dashboard wire harness B (right branch) (see page 203-10)	
2	C452	2-GRY	Under right side of dash		

## Antenna Amplifier Sub-harness (USA: Base, CR Audio – A/C; Canada)

Ref	Connector or Terminal	Cavities/ Color	Location	Connects to	Notes
3	C551	2-GRY	Behind lower center of dash	Dashboard wire harness A (see page 203-12)	
4	AM/FM antenna amplifier	2-GRY	Right side of trunk		

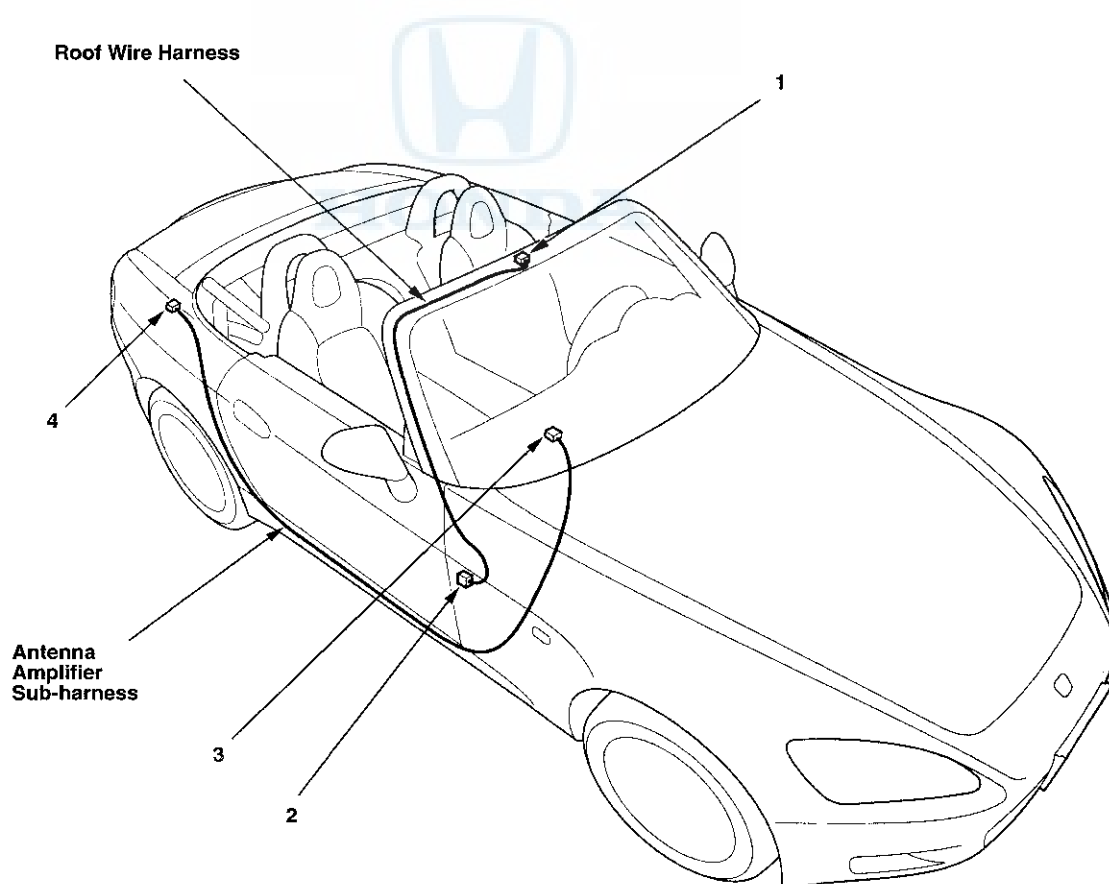





## SRS Main Wire Harness

Ref	Connector or Terminal	Cavities/Color	Location	Connects to	Notes
1	MES connector (see page 6-5)	2-YEL	Under left side of dash	Dashboard wire harness A (see page 203-12)	
2	Under-dash fuse/relay box connector A (see page 6-5)	2-YEL	Under left side of dash		
4	C503	6-YEL	Under left side of dash		
5	Cable reel connector A	4-YEL	In steering column cover		
6	SRS unit connector A	28-YEL	Behind lower center of dash	Right engine compartment wire harness (see page 203-4)	
7	SRS unit connector B	28-YEL	Behind lower center of dash		
8	Passenger's airbag first and second inflators	4-YEL	Under right side of dash	Rear wire harness (left branch) (see page 203-14)	
9	C205	4-YEL	Under right side of dash		
10	Passenger's seat belt tensioner	2-YEL	Behind passenger's roll bar	Body ground via SRS main wire harness	
11	C603	8-GRY	Behind rear of console		
12	Driver's seat belt tensioner	2-YEL	Behind driver's roll bar	Left engine compartment wire harness (see page 203-6)	
13	G801	2-YEL	Behind lower center of dash		
14	C305	4-YEL	Under left side of dash		

## Ignition Switch Lead

Ref	Connector or Terminal	Cavities/Color	Location	Connects to	Notes
3	Under-dash fuse/relay box connector B (see page 6-5)	7-BRN	Under left side of dash		

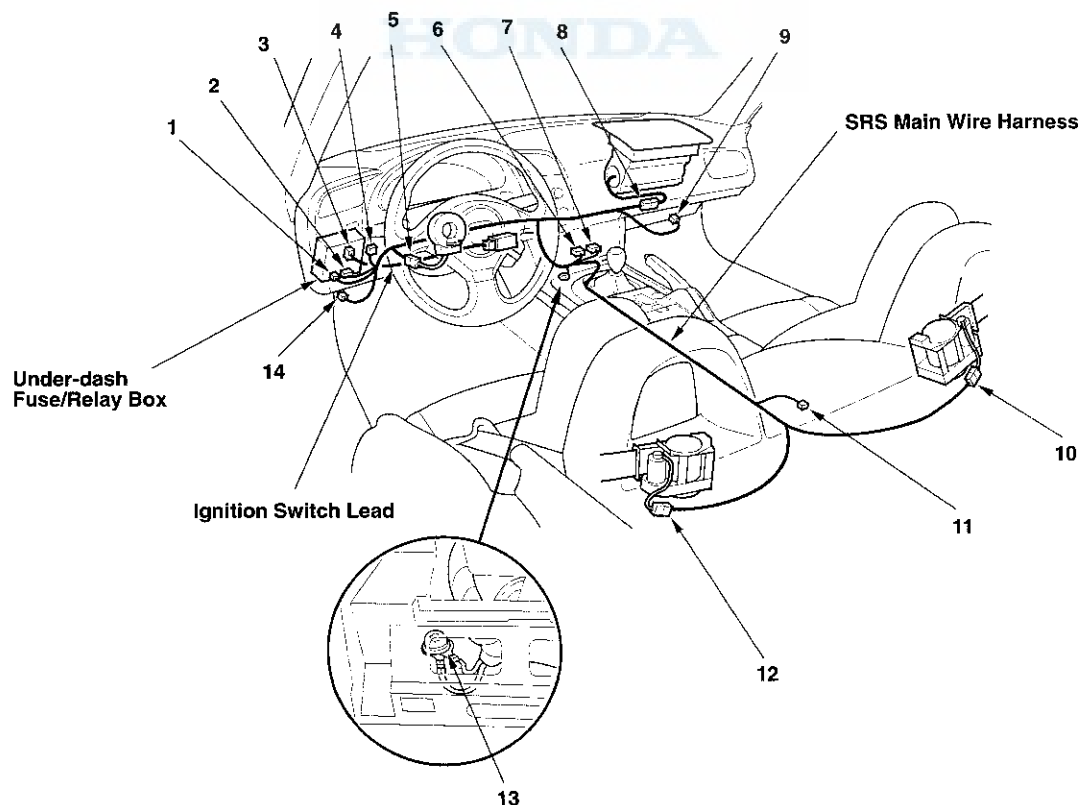

# Connector to Harness Index

## Driver's Door Wire Harness

Ref	Connector or Terminal	Cavities/ Color	Location	Connects to	Notes
1	Left power mirror	3-GRY	Driver's door	Dashboard wire harness A (see page 203-12)	*1
2	C502	20-GRY	Behind left kick panel		
3	Driver's door speaker	2-GRY	Driver's door		
4	Power window master switch	14-GRY	Driver's door		
5	Power mirror switch	10-GRN	Driver's door		
6	Driver's power window motor	4-GRY/ LT GRN	Driver's door		
7	Driver's door key cylinder switch	2-GRY	Driver's door		
8	Driver's door latch connector B	2-GRY	Driver's door		
9	Driver's door latch connector A	3-GRY	Driver's door		
10	Left tweeter	2-GRY	Driver's door		

\*1 = USA: Base, CR Audio – A/C; Canada

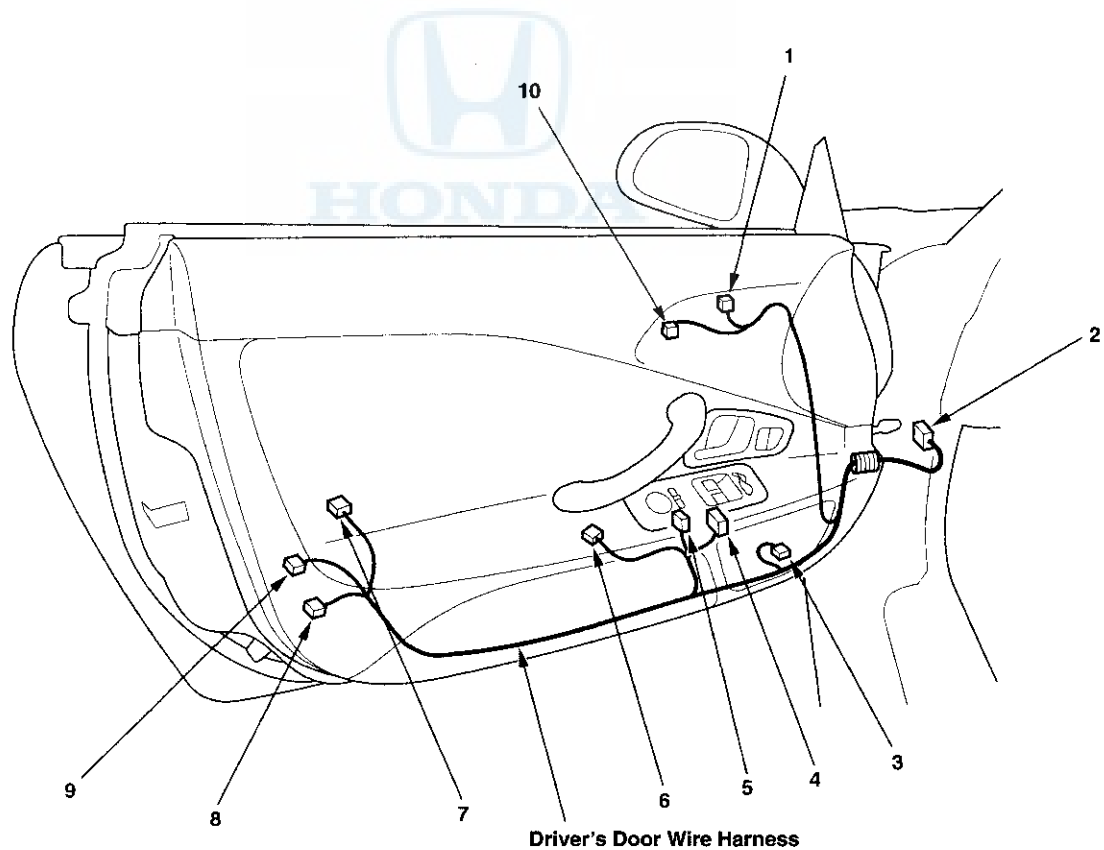



## Passenger's Door Wire Harness

Ref	Connector or Terminal	Cavities/Color	Location	Connects to	Notes
1	C504	16-GRY	Under right side of dash	Dashboard wire harness A (see page 203-12)	
2	Right power mirror	3-GRY	Passenger's door		*1
3	Passenger's door speaker	2-GRY	Passenger's door		
4	Passenger's power window switch	6-GRN	Passenger's door		
5	Passenger's power window motor	2-GRY	Passenger's door		
6	Passenger's door lock actuator	2-GRY	Passenger's door		
7	Right tweeter	2-GRY	Passenger's door		*1

\*1 = USA: Base, CR Audio – A/C; Canada

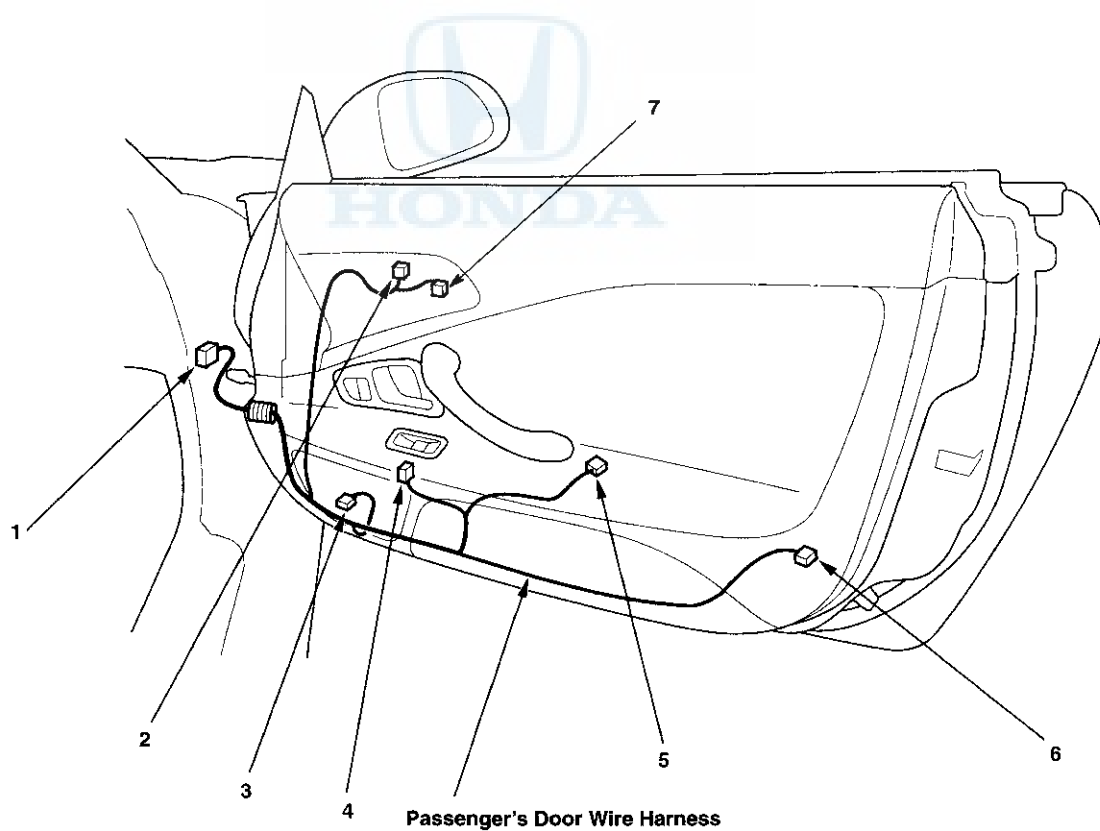

# Connector to Harness Index

## Hardtop Sub-harness (Removable Hardtop) (USA: CR, CR Audio – A/C)

Ref	Connector or Terminal	Cavities/Color	Location	Connects to	Notes
3	C601	3-GRY	Under driver's roll bar	Rear wire harness (left branch) (see page 203-14)	
5 7	Convertible top disable switch C901	2-GRY 3-BLK	Under driver's roll bar Behind left side rear trim		Hardtop wire harness (see this page)

## Hardtop Wire Harness (Removable Hardtop) (CR, CR Audio – A/C)

Ref	Connector or Terminal	Cavities/Color	Location	Connects to	Notes
4 6	Rear window defogger connector A (+) G901	1-NAT	Left side of hardtop Left side of hardtop	Body ground via hardtop wire harness Hardtop sub-harness (see this page)	
8	C901	3-BLK	Behind left side rear trim		

## Rear Window Defogger Ground Wire (Removable Hardtop) (CR, CR Audio – A/C)

Ref	Connector or Terminal	Cavities/Color	Location	Connects to	Notes
1	G902		Right side of hardtop	Body ground via rear window defogger ground wire	
2	Rear window defogger connector B (-)	1-NAT	Right side of hardtop		

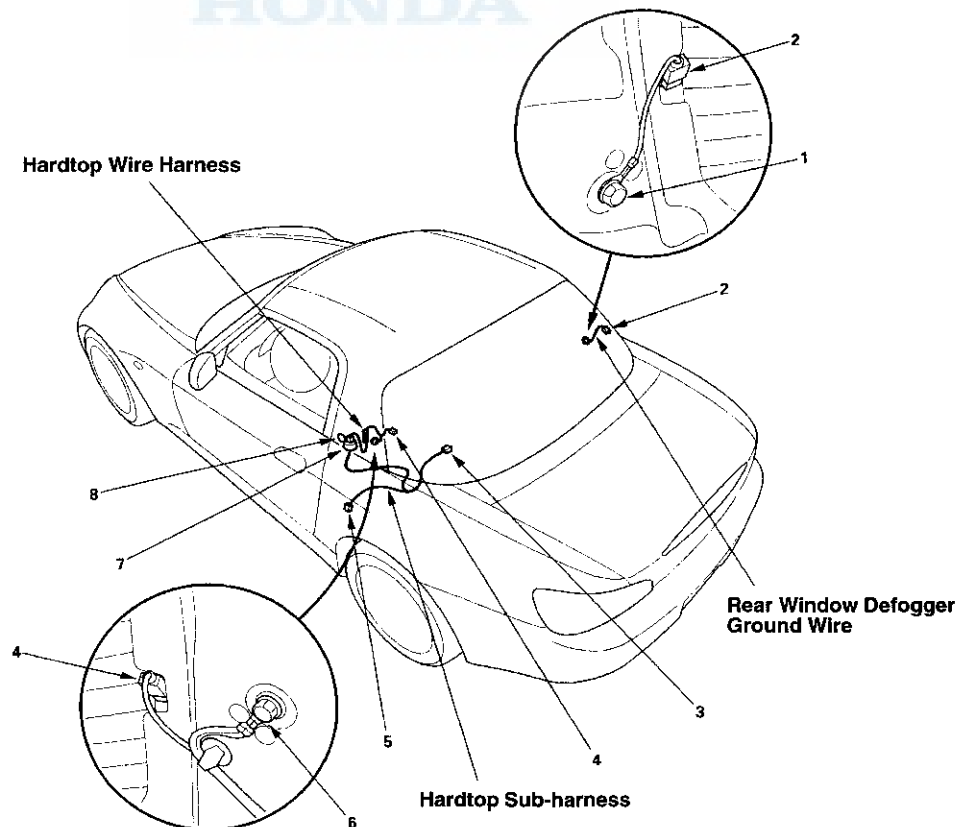

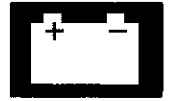

### Rear Window Defogger Sub-harness (Softtop) (USA: Base; Canada)

Ref	Connector or Terminal	Cavities/ Color	Location	Connects to	Notes
1	Rear window defogger connector A	1-BLK	Left side of softtop	Rear wire harness (left branch) (see page 203-14)	
2	Rear window defogger connector B	1-BLK	Left side of softtop		
3	C602	2-BRN	Left side of trunk		

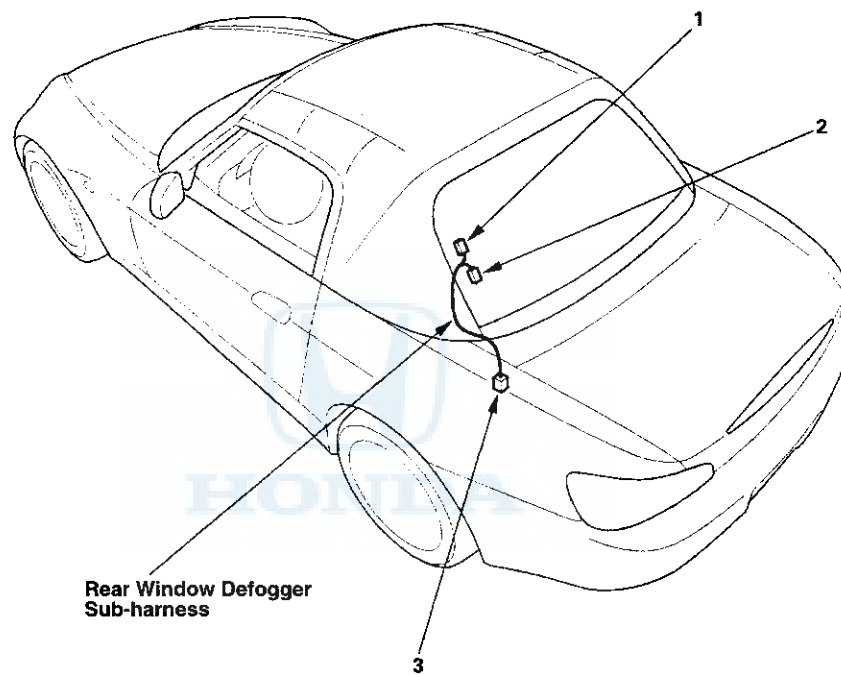

# Terminal Replacement Procedures

## Terminal Replacement Procedure

### HOW TO REPLACE CONNECTOR TERMINALS

The terminal repair kits provide necessary tools and materials (terminals, wire seals, and splice connectors) to repair many damaged or faulty connector terminals. However, not all terminals for all connectors are available. Refer to the labels on the lids of the repair kits for replacement terminal availability.

### IMPORTANT SAFETY INFORMATION:

**On some models, the SRS wires are in a separate harness. If the SRS harness is damaged, replace the harness; do not repair it. On other models, wire harnesses include yellow SRS wires. If any SRS wire is damaged, replace the entire harness; do not repair it.**

Before you begin, inspect the wire you are about to repair for damage and length. Make sure the wire will be long enough to make a terminal repair without stretching it when you reinstall the terminal in the connector. If the wire is too short, or if access to the connector is too restricted to make a terminal repair, you may need to install a pigtail terminal (a short length of wire with a factory-crimped terminal on it). Refer to HOW TO INSTALL PIGTAIL TERMINALS.

### Removing the Terminal

Use the tools from Pin Tool Set.

First, check the connector that you are about to repair.

- If it has a secondary terminal lock, go to Connectors With a Secondary Lock. A secondary lock, found on most connectors on some models, is an additional locking device on the connector housing as a backup for the primary lock on the terminal.
- If the connector does not have a secondary lock, go to Connectors Without a Secondary Lock.

### Connectors With a Secondary Lock

All examples are shown with the connector lock facing up. The illustrations are examples of the secondary terminal locks; however, the connector you are repairing may vary in size. Identify the connector by the type of secondary lock, not by the number of terminal cavities.

#### EXAMPLE A:

1. Release the secondary lock.

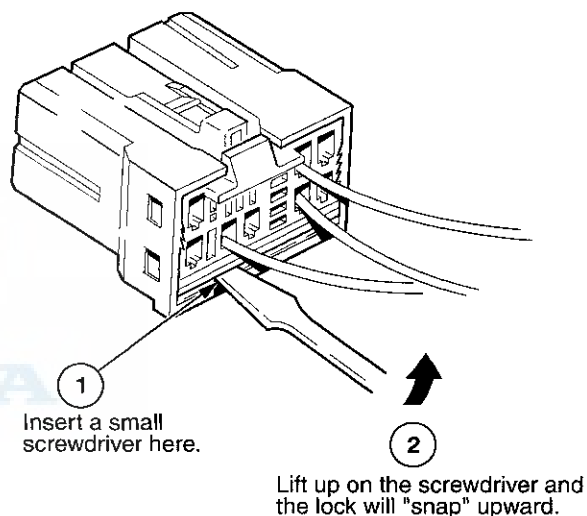

2. Remove the terminal.

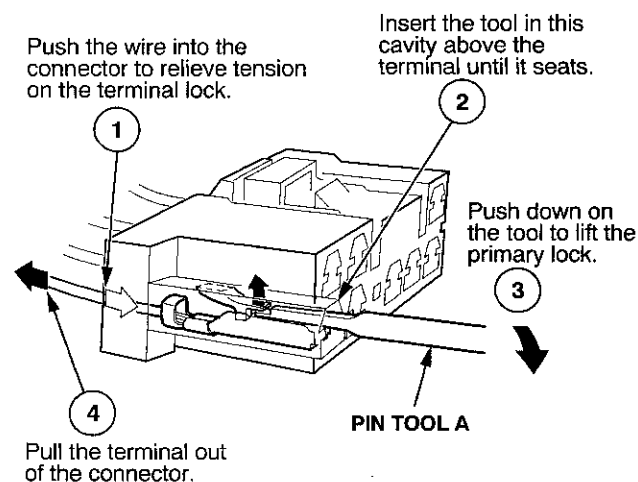

3. Go to HOW TO INSTALL NEW TERMINALS.



### EXAMPLE B:

1. Remove the secondary lock from the male terminal half.

– Male Terminal Half

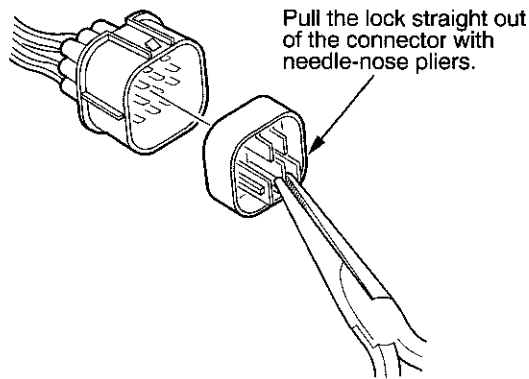

2. Remove the secondary lock from the female terminal half.

– Female Terminal Half

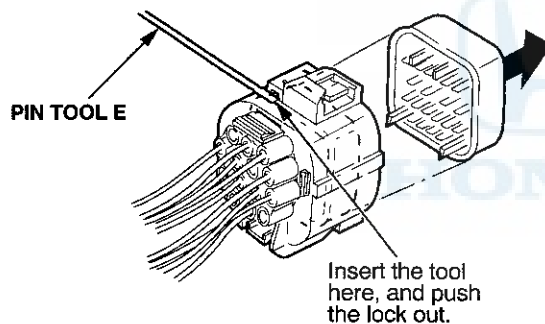

3. Remove the terminal (same procedure for male and female).

Push the wire into the connector to relieve the tension on the primary lock.

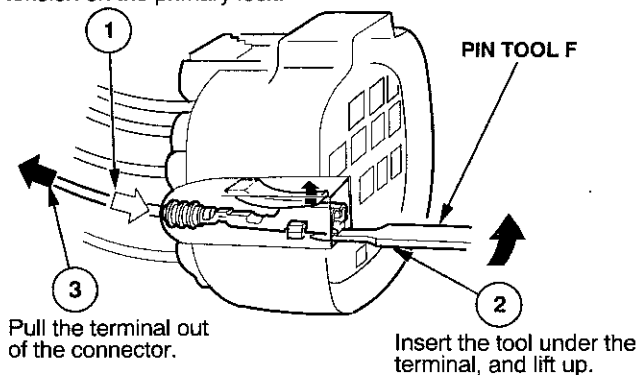

4. Go to HOW TO INSTALL NEW TERMINALS.

### EXAMPLE C:

1. Remove the secondary lock.

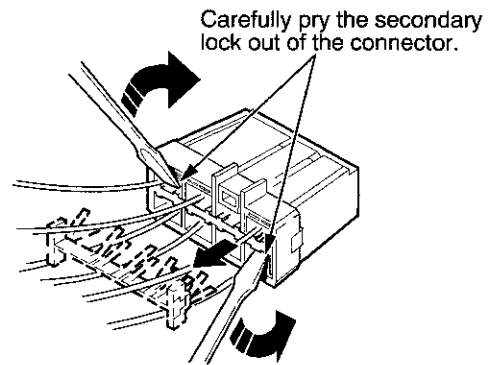

2. Remove the terminal from the female half.

– Female Terminal Half

Push the wire into the connector to relieve the tension on the primary lock.

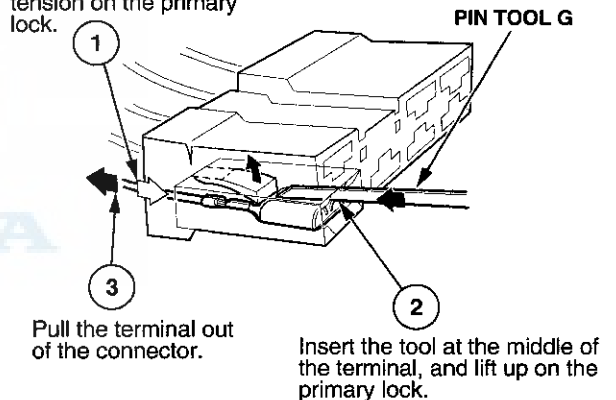

3. Remove the terminal from the male half.

– Male Terminal Half

Push the wire into the connector to relieve the tension on the primary lock.

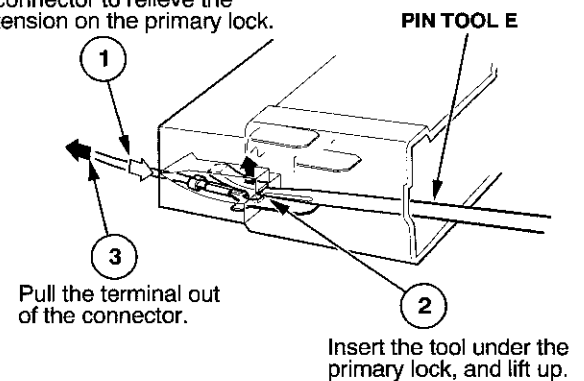

4. Go to HOW TO INSTALL NEW TERMINALS.

# Terminal Replacement Procedures

## EXAMPLE D:

1. Remove the secondary locks.

Pry out on the tabs on both sides.

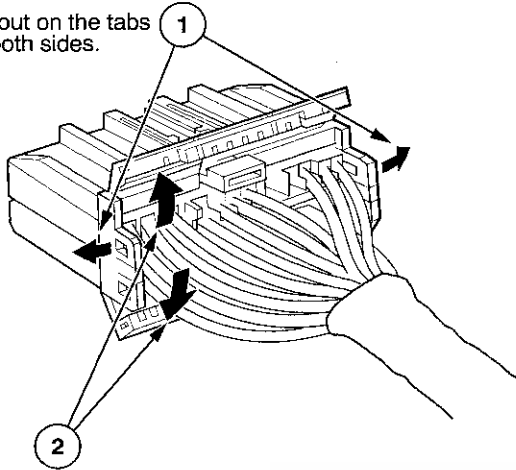

Roll the upper and lower locks in the direction of the arrows.

2. Remove the terminal (same procedure for male and female).

Push the wire into the connector to relieve the tension on the primary lock.

Insert the tool into the upper half of the terminal cavity.

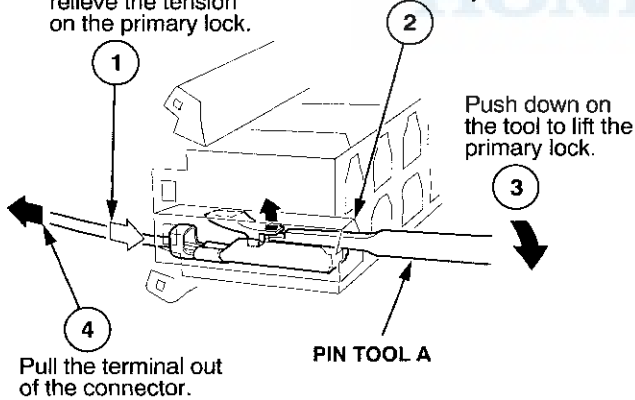

3. Go to HOW TO INSTALL NEW TERMINALS.

## EXAMPLE E:

1. Remove the secondary locks.

Gently pry up on the back of the secondary terminal lock.

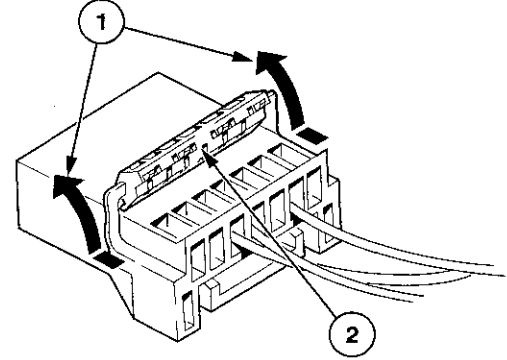

Roll the secondary lock up so the lugs of the lock are free of the connector.

2. Remove the terminal (same procedure for male and female).

Push the wire into the connector to relieve the tension on the primary lock.

Insert the tool into the larger hole in the face of the connector.

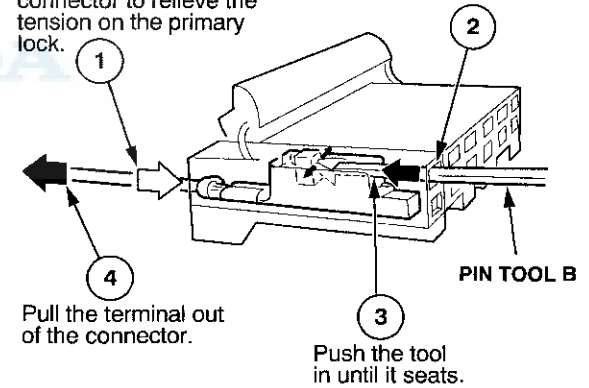

3. Go to HOW TO INSTALL NEW TERMINALS.





### EXAMPLE F:

1. Remove the secondary locks.

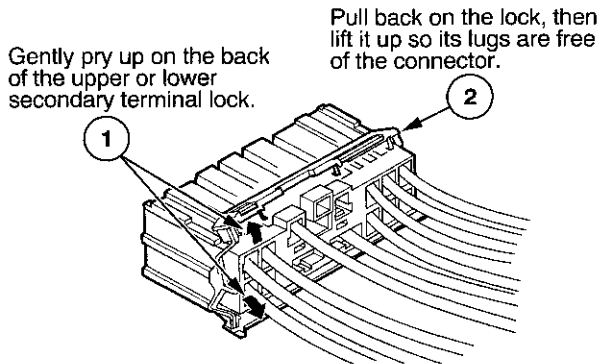

2. Remove the terminal from the female half.

– Female Terminal Half

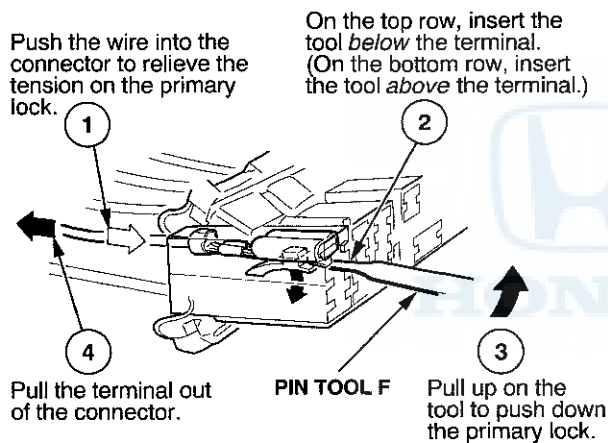

3. Remove the terminal from the male half.

– Male Terminal Half

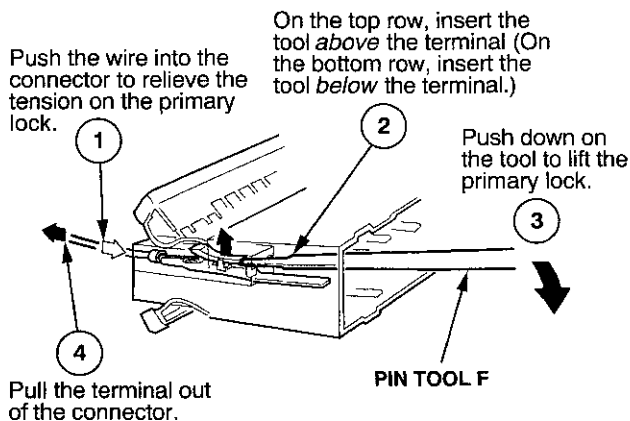

4. Go to HOW TO INSTALL NEW TERMINALS.

### Connectors *Without* a Secondary Lock

All examples are shown with the connector lock facing up. The illustrations are examples of connector terminals without a secondary lock; however, the connector you are repairing may vary in size and shape.

### EXAMPLE A:

1. Remove the terminal.

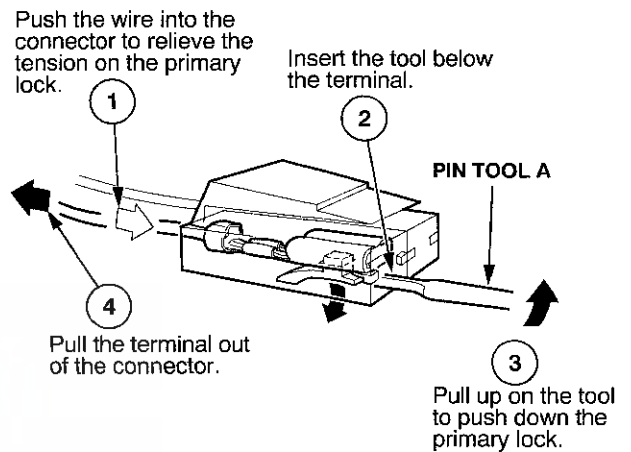

2. Go to HOW TO INSTALL NEW TERMINALS.

### EXAMPLE B:

1. Remove the terminal.

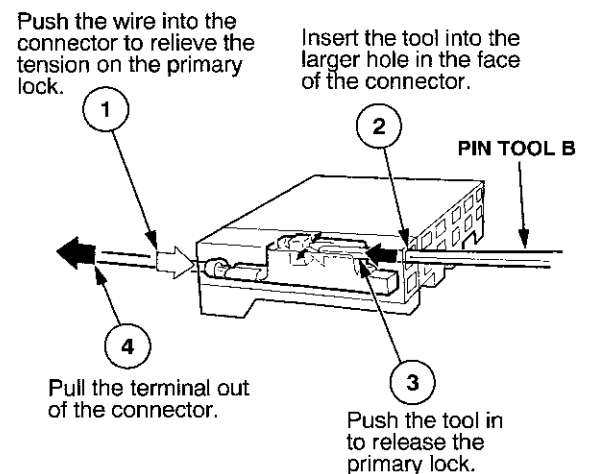

2. Go to HOW TO INSTALL NEW TERMINALS.

# Terminal Replacement Procedures

## EXAMPLE C:

1. Remove the terminal.

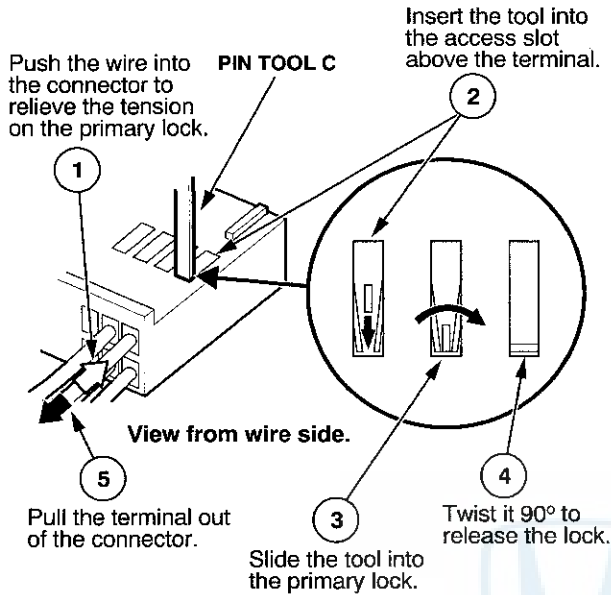

2. Go to HOW TO INSTALL NEW TERMINALS.

## EXAMPLE D:

1. Remove the terminal.

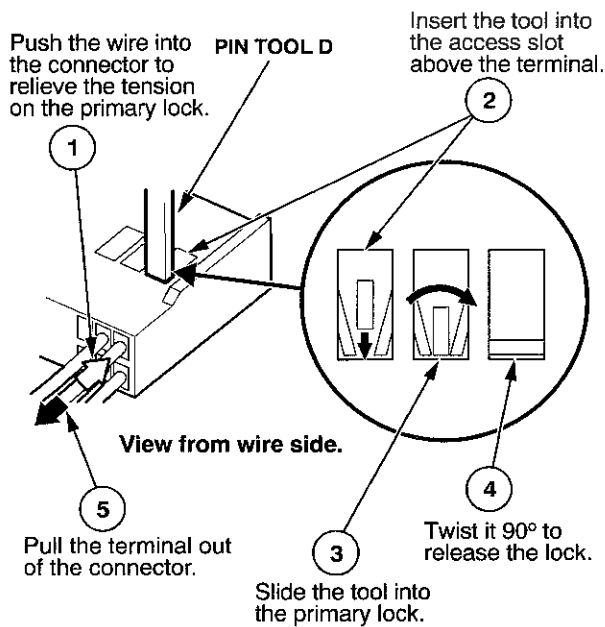

2. Go to HOW TO INSTALL NEW TERMINALS.

## EXAMPLE E:

1. Remove the terminal.

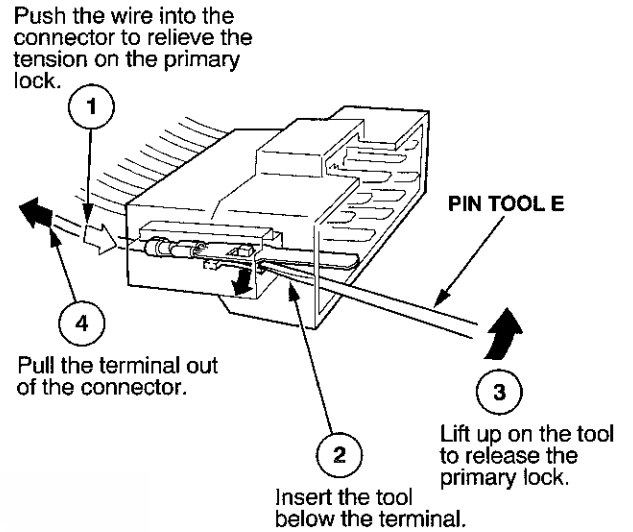

2. Go to HOW TO INSTALL NEW TERMINALS.

## EXAMPLE F:

1. Remove the terminal.

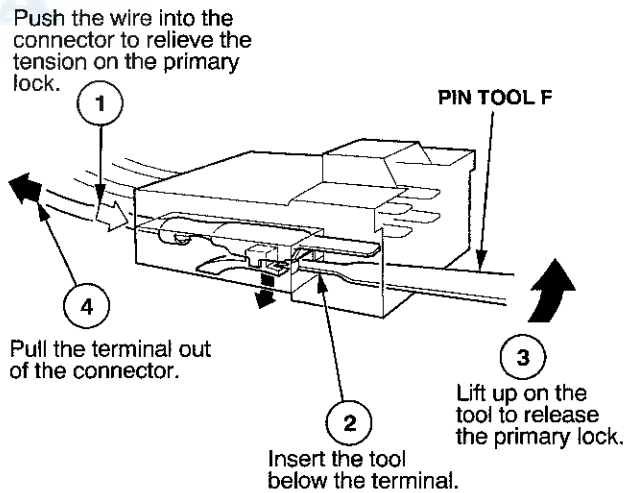

2. Go to HOW TO INSTALL NEW TERMINALS.



### EXAMPLE G:

1. Remove the terminal.

Push the wire into the connector to relieve the tension on the primary lock.

Insert the tool at the middle of the terminal.

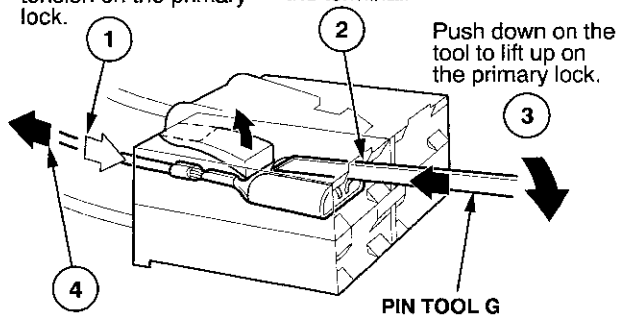

Pull the terminal out of the connector.

2. Go to HOW TO INSTALL NEW TERMINALS.

### HOW TO INSTALL NEW TERMINALS

1. Carefully match the old terminal with a new one from the terminal repair kit. Choose the correct replacement terminal based on the wire size range the terminal will accommodate.

NOTE: If the replacement terminal quantities are low, reorder them by using the terminal part number listed on the inside lid of the terminal repair kit. Replacement terminals are available through your parts department using normal parts ordering procedures.

2. Depending on the size of the wire you are repairing, use the proper size slot in the crimping tool.

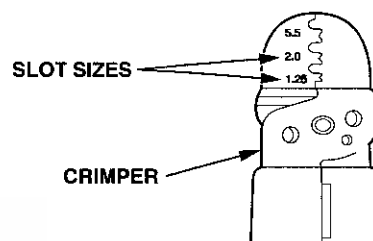

3. Strip the insulation off the end of the wire so the wire fits in the new terminal as shown. (If the wire has a wire seal, replace it with a new one from the kit.)

NOTE: After stripping the end of the wire, make sure you did not cut any wire strands. If you did, cut the wire off even with the insulation, and strip it again.

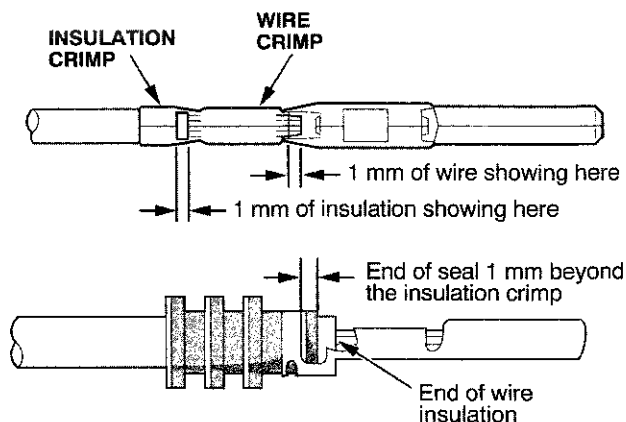

# Terminal Replacement Procedures

4. Position the terminal in the crimping tool slot with the solid portion of the terminal toward the anvil and the open section toward the former.

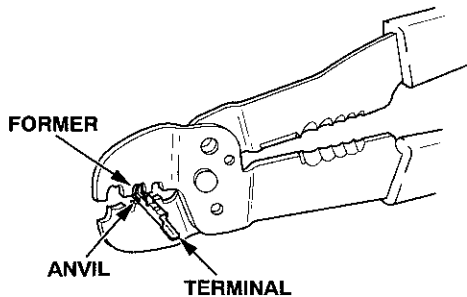

5. Insert the wire in the terminal to the position shown in step 3.  
 6. Squeeze the tool with both hands until the stops make contact.

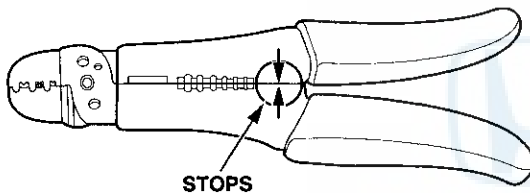

7. Crimp the insulation crimp.
- If you do not have a wire seal, then use the next larger size crimp slot. Position the crimping tool over the insulation crimp section of the terminal, then squeeze the tool with both hands until the stops make contact.
  - If you have a wire seal, position the insulation crimp in the 5.5 crimping slot, then carefully squeeze the crimp closed until its ends are touching and making a full-circle shape.

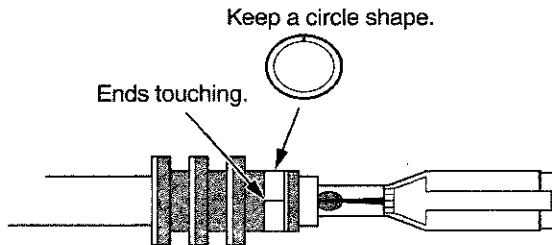

8. Inspect the quality of the wire crimp. If it has any of the following NO GOOD crimps, cut it off and start over.

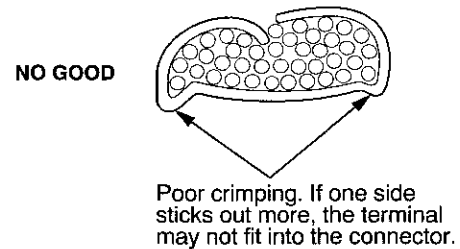
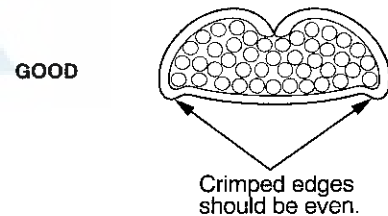
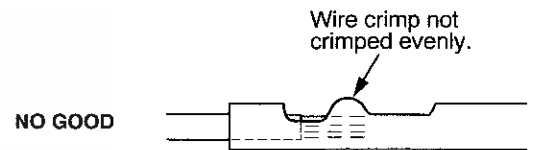
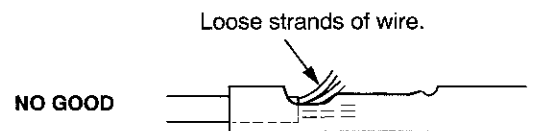
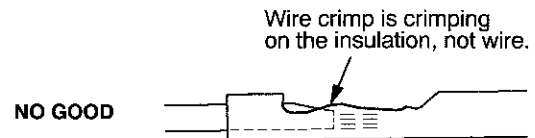
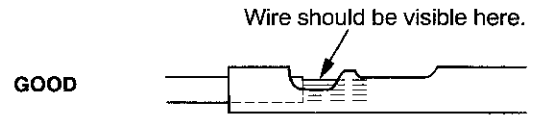

9. Insert the terminal into the connector. Make sure the wire seals are pushed all the way into the connector. Lightly pull on the wires to make sure the terminal is locked into place.  
 10. Close or insert the secondary terminal lock, if applicable, and reconnect the connector.

## HOW TO INSTALL PIGTAIL TERMINALS

Pigtail terminals (short pieces of wire with a factory crimped terminal) are used when the wire is too short or when access to the connector is too restricted to make a terminal repair.



NOTE: To replace just a connector terminal, go to *How to Replace Connector Terminals*.

**IMPORTANT SAFETY INFORMATION:**

On some models, the SRS wires are in a separate harness. If the SRS harness is damaged, replace the harness; do not repair it. On other models, wire harnesses include yellow SRS wires. If any SRS wire is damaged, replace the entire harness; do not repair it.

1. Remove the damaged or faulty terminal from the connector. Use the proper removal tool from Pin Tool Set.
2. Cut off the wire about an inch back from where it connects to the damaged or faulty terminal, then strip about half of the insulation off that piece. This will be used to size the wire end of the replacement pigtail terminal.

NOTE: If you are not sure of the wire size, start with a large enough hole on the stripper that will not nick or cut off any strands of wires.

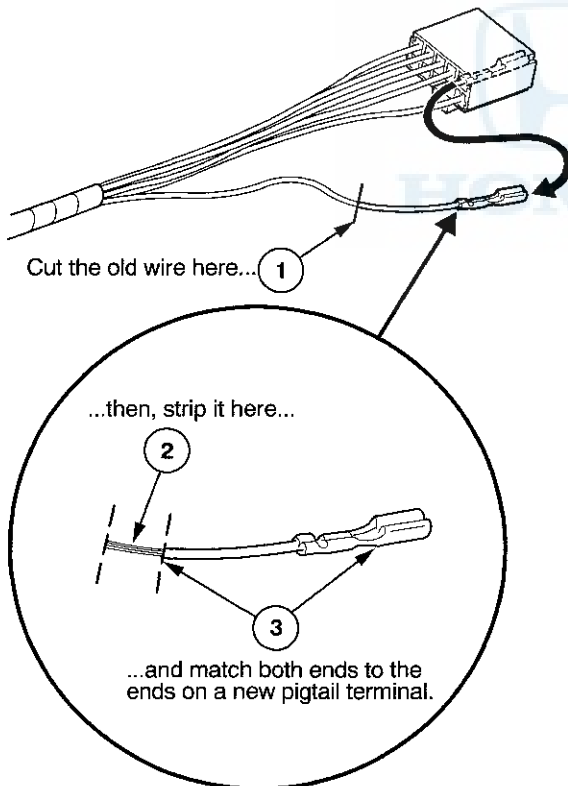

3. Select a pigtail terminal that matches the original wire at both ends (same kind of terminal and same diameter bare wire).
4. Select the smallest splice connector (yellow, pink, or blue) that will fit onto the stripped end of the original wire.

5. Insert the pigtail terminal into the connector cavity; push it in until it locks in place.

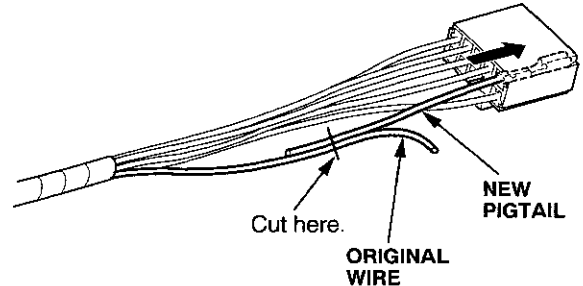

6. Lay the pigtail and the original wire side-by-side, and cut off both ends at once. If you are making more than one splice, do not cut each pigtail at the same location; the resulting "lump" of splice connectors would interfere with rewrapping the harness. Instead, cut the first pigtail close enough to the terminal so you will have room to make each remaining cut about 20 mm (3/4 inch) farther down on the next pigtail.
7. If you are using a yellow splice connector, strip about 6 mm (1/4 inch) of insulation off the ends of both wires. If you are using a pink or blue splice connector, strip off about 8 mm (5/16 inch) of insulation.

NOTE: If you nick or cut off any strands of wire, try again with the next larger size hole on the stripper.

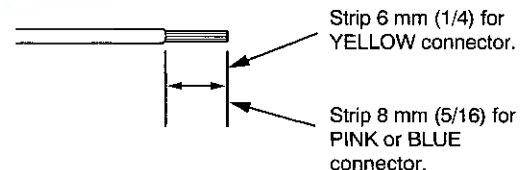

# Terminal Replacement Procedures

- Put the splice connector in the proper size slot in the Crimper Tool, slide it to one end (where the flare begins), and close the crimper handles far enough to hold it in place. To release the ratchet mechanism at any point after the first click, squeeze the handles slightly and push the release lever, then let the handles open.

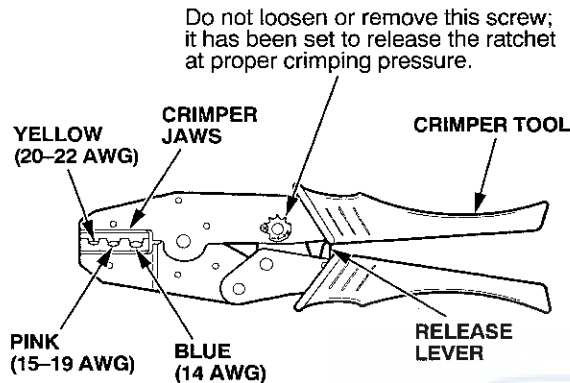

- Insert one of the bare wires into the splice connector end that is in the crimper jaws. Push the wire all the way into the splice connector, and squeeze the crimper handles. Keep squeezing until the jaws touch, and hold it at that position until the ratchet clicks again.

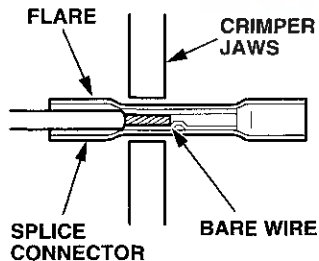

- Crimp the other wire in the same way into the other end of the splice connector.
- After crimping, gently pull on the wires in the opposite directions to make sure they are secure in the connector.

- Separate the other wires in the harness from the repaired wire(s), and shield them with nonflammable material.

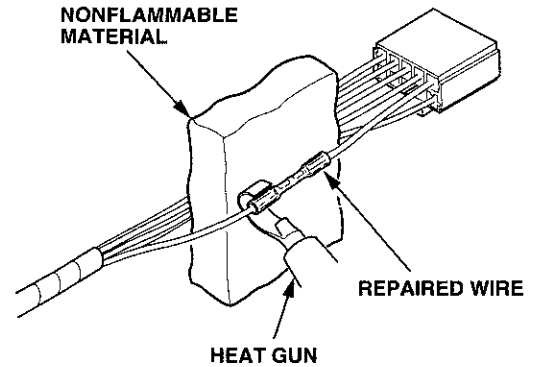

- Plug in the heat gun, and turn it on. Start at the middle of the splice connector, and move the gun toward the ends as the tube shrinks. Apply heat evenly by rotating the curved heat spreader around the splice connector. Shrinking is complete when a small amount of sealant appears at each end of the tube.

NOTE: Be careful when working with the high heat produced by the heat gun.

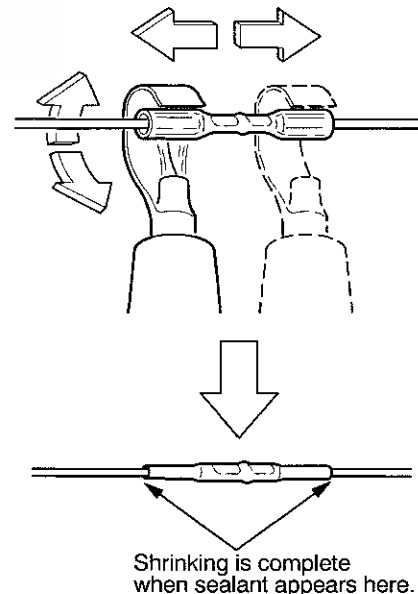



### PIGTAIL TERMINAL SELECTION CHART

Select the proper size pigtail terminal by matching the replacement terminal part number and the wire size being repaired to the corresponding pigtail terminal part number. Then use the color (size) splice connector listed. In some instances you may also have to match the wire seal style to select the proper pigtail terminal. Pigtail terminals are available through your parts department, in quantities of 10, using normal parts ordering procedures.

#### Wire Seal Type

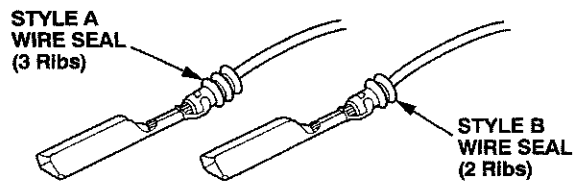

### CHECKING FOR POOR FIT OF TERMINALS

Loose terminal fit can cause a number of intermittent problems in electrical circuits. By using the Terminal Inspection Feeler Tool Set you can inspect the terminal fit between the two matching connectors without removing the terminals from the connector body.

1. Find the terminal tool that best matches the male terminal in the mating connector.
2. Insert the terminal tool into the female terminal, and then remove the terminal tool.

**NOTE:** Make sure you do not select a terminal tool that is larger than the mating male terminal because it would spread the female terminal and cause a loose fit.

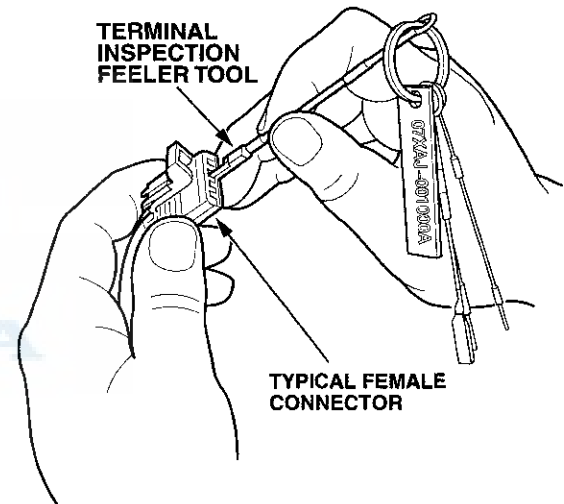

3. Compare the drag to the other terminals in the connector. If the drag is less, replace the terminal with a replacement terminal from the appropriate terminal repair kit.

## NOTES





## NOTES



## NOTES







**" Portions of materials contained herein have been reprinted under license from America Honda Motor Co., Inc. License Agreement AH220 ."**